

SUBMITTAL DATA

4LIV07HP230V1AH for Use with Multi GEN2 and Multi+ Ultra
7000 BTU/H Wall Mounted Unit

Job Name <input type="text"/>	Location <input type="text"/>	Date <input type="text"/>
Purchaser <input type="text"/>	Engineer <input type="text"/>	
Submitted to <input type="text"/>	For <input type="text"/>	
Unit Designation <input type="text"/>	Schedule No. <input type="text"/>	



YAP1FB2F



4LIV07HP230V1AH



XE71 (Optional)

GENERAL FEATURES

- High Efficiency DC Inverter Technology
- Compact and Quiet Design
- Auto-Clean Function
- Wireless Remote with LCD Display
- Wired Controller Options
- Wi-Fi Included
- Low Ambient Cooling Based on Outdoor Unit Performance
- Low Ambient Heating Based on Outdoor Unit Performance
- Coil (Indoor and Outdoor) Copper Tube / Aluminum Fin
- Blue Colored Fin - 500 Hrs Salt Spray Tested

SPECIFICATIONS, FEATURES & FUNCTION SUMMARY

SPECIFICATIONS		4LIV07HP230V1AH		FEATURES & FUNCTIONS SUMMARY		4LIV07HP230V1AH	
System Type		HEAT PUMP					
SYSTEM PERFORMANCE				SYSTEM FEATURES			
Cooling	Nominal	Btu/h	7000	Wired Controller Interface (XE71)	Yes		
	Capacity @95°F	Btu/h		WiFi Included	Yes		
Heating	Nominal	Btu/h	8000	Indoor Fan Type	Crossflow		
	Capacity @5°F	Btu/h		Multi Fan Speeds	4 Speeds		
	Capacity @17°F	Btu/h		Indoor Unit Display	Yes		
	Capacity @47°F	W		Auxiliary Electrical Heater	No		
SEER2				Ventilation (Outdoor Air)	No		
EER2				REMOTE CONTROLLER FUNCTIONS			
HSPF2				Auto Mode	Yes		
COP @5°F				Auto Fan	Yes		
COP @47°F				Manual Horizontal Swing	Yes		
Cooling Temperature Range	°F			Auto Swing (Vertical Auto Swing)	Yes		
Heating Temperature Range	°F			Clock on Remote Controller	Yes		
Refrigerant Type			R410A	Dry Mode	Yes		
INDOOR UNIT		4LIV07HP230V1AH		Dry Anti-Mildew (X-Fan) Mode	Yes		
Air flow (Min-Max)	CFM	135 - 258		Energy Saving Mode	Yes		
Sound Pressure Level (Min - Max)	dB(A)	24 - 39		Dirty Filter Alert	No		
Dehumidification	pt/hr	1.27		I Feel Function	Yes		
External Dimensions (WxHxD)	in	27-7/8 x 10-1/4 x 7-5/16		Lock on Remote Controller	Yes		
Package Dimension (W x H x D)	in	29-5/8 x 13-1/16 x 10-3/16		Quiet Mode	No		
Net Weight	lbs	15.4		Room Temperature Display	Yes		
Gross Weight	lbs	18.7		Sleep Mode	Yes		
REFRIGERANT PIPING				Timer Mode	Yes		
Line Set Sized by the Indoor Unit (Liquid - Gas) - Flared Connections	in	1/4 - 3/8		Turbo Mode	Yes		
ELECTRICAL				Display On/Off Control	Yes		
Power Supply	208 - 230V / 1Ph /60Hz (Powered by the Outdoor Unit)			Freeze Guard Mode (46°F)	Yes		
				Display On/Off Control	Yes		

DIMENSIONS & CLEARANCES

INDOOR UNIT

Unit: inch

4LIV07HP230V1AH	
DIMENSIONS	
W	27-7/8
H	10-1/4
D	7-5/16
W1	3-25/32
W2	18-5/32
W3	5-15/16

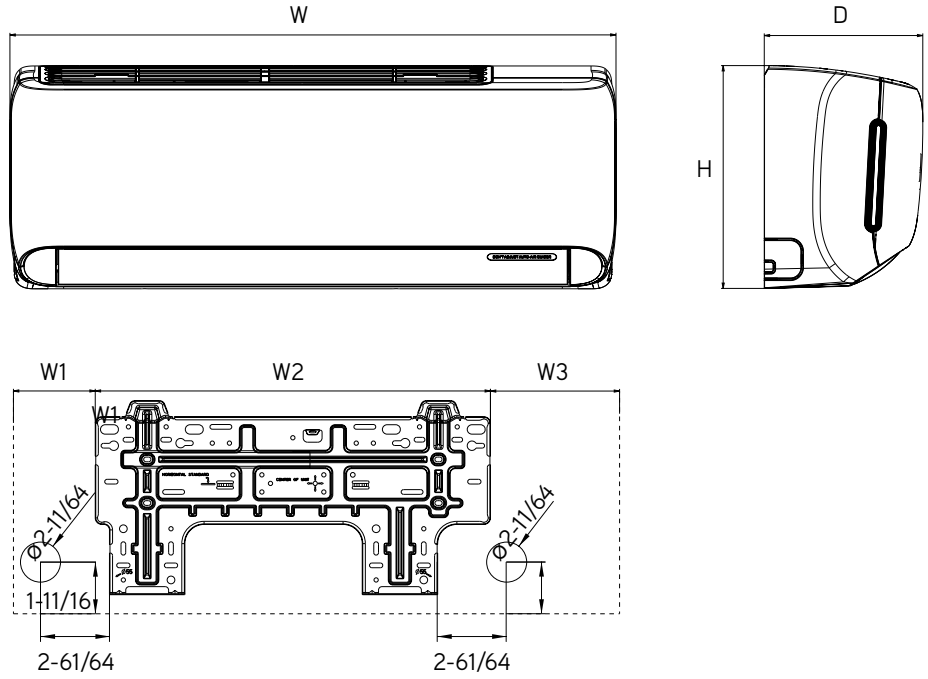

INDOOR UNIT

Minimum clearance

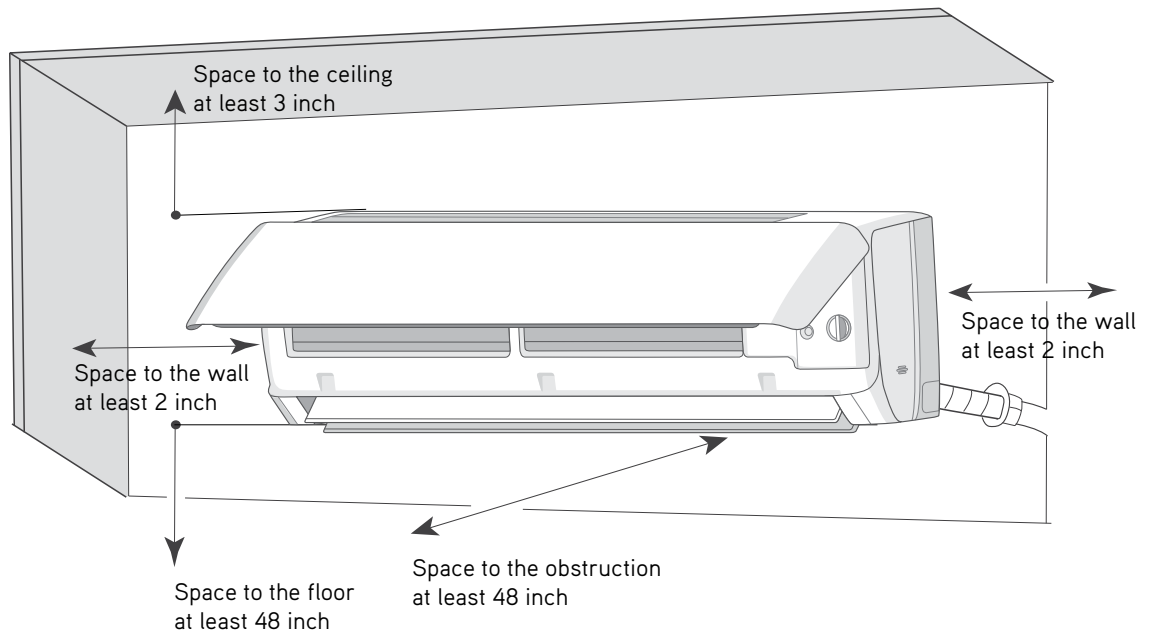

Specifications are subject to change without notice. Manufacturer reserves the right to discontinue or modify specifications or designs without notice or without incurring obligations. All Rights reserved.

GREECOMFORT.COM/SYSTEM-DOCUMENTATION