



For Use with GREE Multi Zone OD Units
MULTI18 Thru MULTI42 Standard and ULTRA SERIES*
 *(Not Compatible with Super+ Multi or Super+ Multi ULTRA)

Submittal Data: LIVV18HP230V1AH 18000 BTU/H (208/230V) Wall Mounted Heat Pump System

Job Name	Location	Date
Purchaser	Engineer	
Submitted To	For <input type="checkbox"/> Reference <input type="checkbox"/> Approval <input type="checkbox"/> Construction	
Unit Designation	Schedule No.	

- GENERAL FEATURES**
- Multi Speed Fan
 - Swing Louvers
 - Compact and Quiet Design
 - Wireless Remote with LCD Display
 - Wi-Fi Ready (Kit Sold Separately) WSBE04
 - Wired Controller (Sold Separately) XE71
 - I Feel Function
 - Blue Fin Condenser Coil
 - 5 year Limited Parts Warranty



System Ratings

Cooling			
Rated Capacity	Btu/hr		17400
SEER		SEE MATCHED OUTDOOR	
EER		UNIT RATINGS	
Heating at 47° F			
Rated Capacity	Btu/hr		18000
HSPF		SEE MATCHED OUTDOOR	
COP		UNIT RATINGS	
Operating Range			
Cooling	(Max)		
	(Min)	SEE MATCHED OUTDOOR	
Heating	(Max)	UNIT RATINGS	
	(Min)		

Indoor Unit Data

Fan Motor Type		Cross-Flow
Output Power	W	60
FLA	A	0.4
Fan Type		Crossflow
Air Filter		Polymeric Mesh
Airflow		
Turbo / Hi / Med / Lo	CFM	471 / 412 / 383 / 335
Sound Pressure Level		
Turbo / Hi / Med / Lo	Clg dB(A)	47 / 44 / 40 / 35
	Htg dB(A)	46 / 44 / 40 / 35
Dehumidification		
	Pints/hr	3.8
Drain Connection		
	in	5/8
Left or Right Drain Line Connection-Gravity Fed		

Refrigerant Piping Data

Refrigerant		R410A
Liquid Pipe Size (OD) Flared	in	1/4
Gas Pipe Size (OD) Flared	in	1/2
Connection Method		Flared
Pre-Charge Length		
MAX Refrigerant Pipe Length	SEE MATCHED OUTDOOR	
MIN Refrigerant Pipe Length	UNIT RATINGS	
MAX Refrigerant Pipe Elevation		

Electrical Data

Power Supply -The indoor unit is powered from the outdoor unit, depending on local code, a disconnect switch may need to be installed to a power supply circuit.

Normal Operational Voltage	208/230V, 1 Ph, 60 Hz
Voltage Range	V 187 - 253
MCA	SEE MATCHED
MOCB/Breaker Size	OUTDOOR UNIT
Interconnecting Wire Size	AWG 14-4
Stranded Copper Conductors THHN 600V Wire	

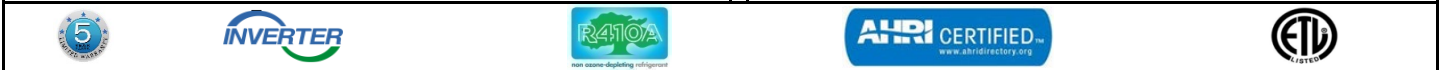

SYSTEM FEATURES	
Indoor Fan Type	Crossflow
Multi Fan Speeds	4 Speeds
Indoor Unit Display	YES
Advanced Filter	Optional
Auxiliary Electrical Heater	NO
Ventilation (Outdoor Air)	NO

REMOTE CONTROLLER FUNCTIONS	
Auto Mode	YES
Auto Fan	YES
Manual Horizontal Swing	YES
Auto Swing (Vertical Auto Swing)	YES
Clock on Remote Controller	YES
Dry Mode	YES
Dry Anti-Mildew (X-Fan) Mode	YES
Energy Saving Mode	YES
Dirty Filter Alert	NO
I Feel Function	YES
Lock on Remote Controller	YES
Quiet Mode	NO
Room Temperature Display	YES
Sleep Mode	YES
Timer Mode	YES
Turbo Mode	YES
Display On/Off Control	YES
Freeze Guard Mode (46 °F)	YES
Display On/Off Control	YES

MINIMUM SPACING REQUIREMENTS

INDOOR

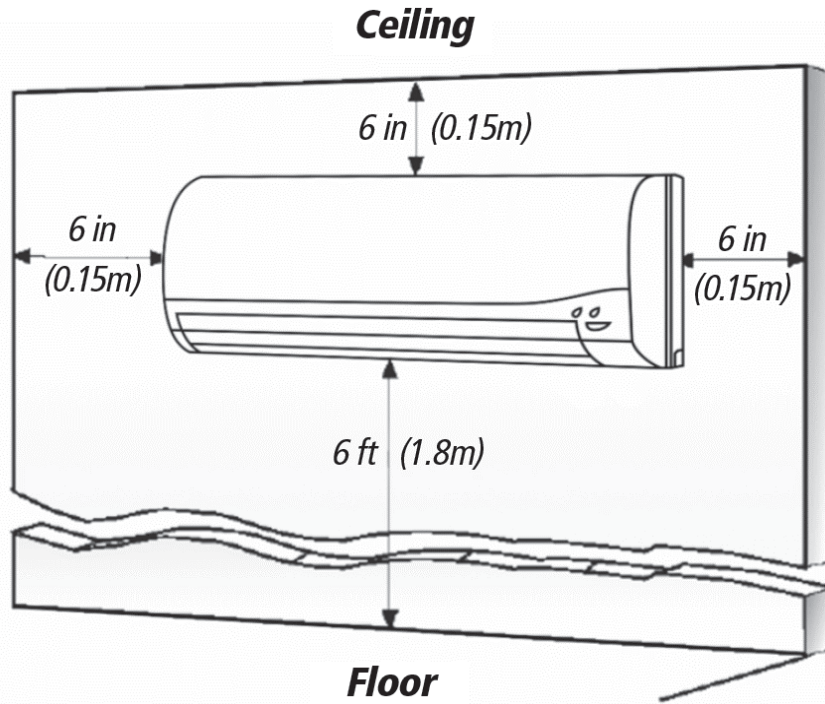

DIMENSIONAL SPECIFICATIONS

INDOOR UNIT DIMENSIONS

Model No: LIVV18HP230V1AH

Units: inch

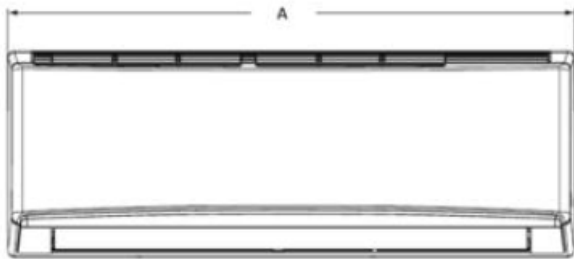

Dimensions	
A	38 1/8
B	11 3/4
C	8 3/4

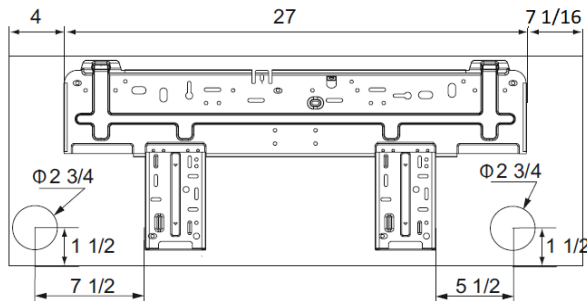

Weight (Net/Gross) 28.6/36.4 lbs

Liquid Line Valve	1/4-in OD Flared
Gas Line Valve	3/8-in OD Flared
Drain Connector	5/8-in OD

Notes:

1. Recommended Interconnecting Cable Type 14 AWG 4 Stranded Copper Conductors THHN 600V Wire