

SUBMITTAL DATA

DUC09HP230V1R32AH
9000 BTU/H Slim Duct (HS) Heat Pump System

Job Name	Location	Date
Purchaser	Engineer	
Submitted to	For	
Unit Designation	Schedule No.	

		
YBE1FB5F	DUC09HP230V1R32AH	XE72-44/E

GENERAL FEATURES

- AHRI Certificate: [215413817 \(Vireo R32\)](#), [215413812 \(Envo R32\)](#), [215415547 \(Sapphire R32\)](#)
- High Efficiency DC Inverter Technology
- Compact and Quiet Design
- Slim Line Construction
- High Static E.S.P Capability -Adjustible
- Internal Condensate Drain Pump
- Flexible Return Air From Bottom Or Rear
- Wireless Remote with LCD Display Included
- XE72-44/E Wi-Fi Wired Controller Included
- Low Ambient Cooling and Heating
- Coil (Indoor and Outdoor) Copper Tube / Aluminum Fin
- Blue Colored Fin - 500 Hrs Salt Spray Tested
- New R32 Refrigerant with Refrigerant Sensor

SPECIFICATIONS, FEATURES & FUNCTION SUMMARY

SYSTEM TYPE			HEAT PUMP		
Indoor Model			DUC09HP230V1R32AH		
Outdoor Model			VIR09HP230V1R32AO	ENV09HP230V1R32AO	SAP09HP230V1R32AO
SYSTEM PERFORMANCE					
Cooling Capacity	Min - Max	Btu/h	2,500 - 12,200	2,500 - 12,200	2,500 - 12,500
	Rated Capacity @95°F	Btu/h	9,100	9,100	9,100
Heating Capacity	Min - Max	Btu/h	2,900 - 13,600	2,900 - 13,600	2,300 - 15,000
	Rated Capacity @47°F	Btu/h	10,500	10,500	10,500
	Rated Capacity @17°F	Btu/h	8,800	8,800	8,900
	Rated Capacity @5°F	Btu/h	9,500	9,500	9,200
SEER2			22.0	22.0	22.3
EER2			14.2	14.2	14.3
HSPF2			9.2	9.2	9.5
COP @5°F			2.15	2.15	1.80
Cooling Temperature Range		°F	-20 - 122		
Heating Temperature Range		°F	-22 - 86		
Refrigerant Type			R32		
INDOOR UNIT			DUC09HP230V1R32AH		
Air flow (Min-Max)		CFM	188 - 324		
External Static Pressure (Max)		In W.c.	0.6		
Sound Pressure Level (Min - Max)		dB(A)	25 - 38		
Dehumidification		pt/hr	1.69		
External Dimensions (L x D x H)		in	32-43/64 x 29-11/16 x 11-13/16		
Package Dimension (L x W x H)		in	35-5/16 x 31-13/16 x 14-11/16		
Net Weight		lbs	70.6		
Gross Weight		lbs	83.8		
OUTDOOR UNIT			VIR09HP230V1R32AO	ENV09HP230V1R32AO	SAP09HP230V1R32AO
Sound Pressure Level		dB(A)	52	52	56
External Dimensions (L x D x H)		in	31-37/64 x 13-25/32 x 21-27/32	31 37/64 x 13 25/32 x 21 27/32	34-3/8 x 14-51/64 x 21-27/32
Package Dimension (L x W x H)		in	34-21/64 x 15-43/64 x 24-13/32	34 21/64 x 15 43/64 x 24 13/32	37-7/16 x 16-31/32 x 24-13/32
Net Weight		lbs	70.6	70.6	78.3
Gross Weight		lbs	76.1	76.1	84.9
REFRIGERANT PIPING					
Refrigerant Charge - R32		oz	30	30	35.3
Additional Charge		oz/ft	0.2	0.2	0.2
Indoor Piping Connection (Liquid - Gas)*		in	1/4 - 3/8		
Outdoor Piping Connection (Liquid - Gas)		in	1/4 - 3/8	1/4 - 3/8	1/4 - 1/2
Pre-Charge Length		ft	25		
Pipe Length (Min - Max)		ft	10 - 66	10 - 66	10 - 131
Max. Pipe Elevation		ft	40	40	82
ELECTRICAL					
Power Supply			208-230V / 1Ph / 60Hz (Powered by the Outdoor Unit)		
Voltage Range (Min - Max)		VAC	187 - 253		
Rated Current - Cooling		A	7.5	7.5	7.5
Rated Current - Heating		A	7.5	7.5	7.5
MOCP		A	15	15	15
MCA		A	10	10	11
Main Power Wire Size		AWG	Per Local Code		
Interconnecting Wire Size		AWG	14 / 4		

* Refrigerant piping must be sized by the indoor unit connections. If the outdoor unit connection is a different size from the indoor unit connection, a flare adapter must be purchased separately and installed on the outdoor unit.

FEATURES & FUNCTIONS SUMMARY	
Inverter Type	G20
Ultra Low Frequency Torque Control	Yes
Power Factor Correction	Yes
Compressor Type - Inverter	High Efficiency Rotary
Basepan With Electric Heater	Yes
Indoor & Outdoor Fin Coating (Blue Fin)	Yes
Intelligent Defrosting	Yes
Intelligent Preheating	Yes
Low Voltage Startup	Yes
Memory/Power Failure Recovery	Yes
Self Diagnosis	Yes
Wired Controller Interface	Yes
WiFi Included	No
Indoor Fan Type	Centrifugal
Multi Fan Speeds	4 Speeds
Indoor Unit Display	No
Auxiliary Electrical Heater	No
Ventilation (Outdoor Air)	No
REMOTE CONTROLLER FUNCTIONS	
Auto Mode	Yes
Auto Fan	Yes
Auto Swing (Horizontal Auto Swing)	No
Auto Swing - 180° (Vertical Auto Swing)	No
Clock	Yes
Dry Mode	Yes
Dry Anti-Mildew (X-Fan) Mode	Yes
Energy Saving Mode	Yes
Dirty Filter Alert	No
Fan Speed Control (7 Speeds)	Yes
I Feel Function	Yes
Privacy Lock	Yes
Quiet Mode	No
Room Temperature Display	No
Sleep Mode	Yes
3 Sleep Mode Options	No
Timer Mode	Yes
Turbo Mode	Yes
Display On/Off Control	No
Freeze Guard Mode	Yes
Power Failure Mode	Yes

NOTE:

Please check the Multi-zone submittals for Ducted or Mixed Performance table.

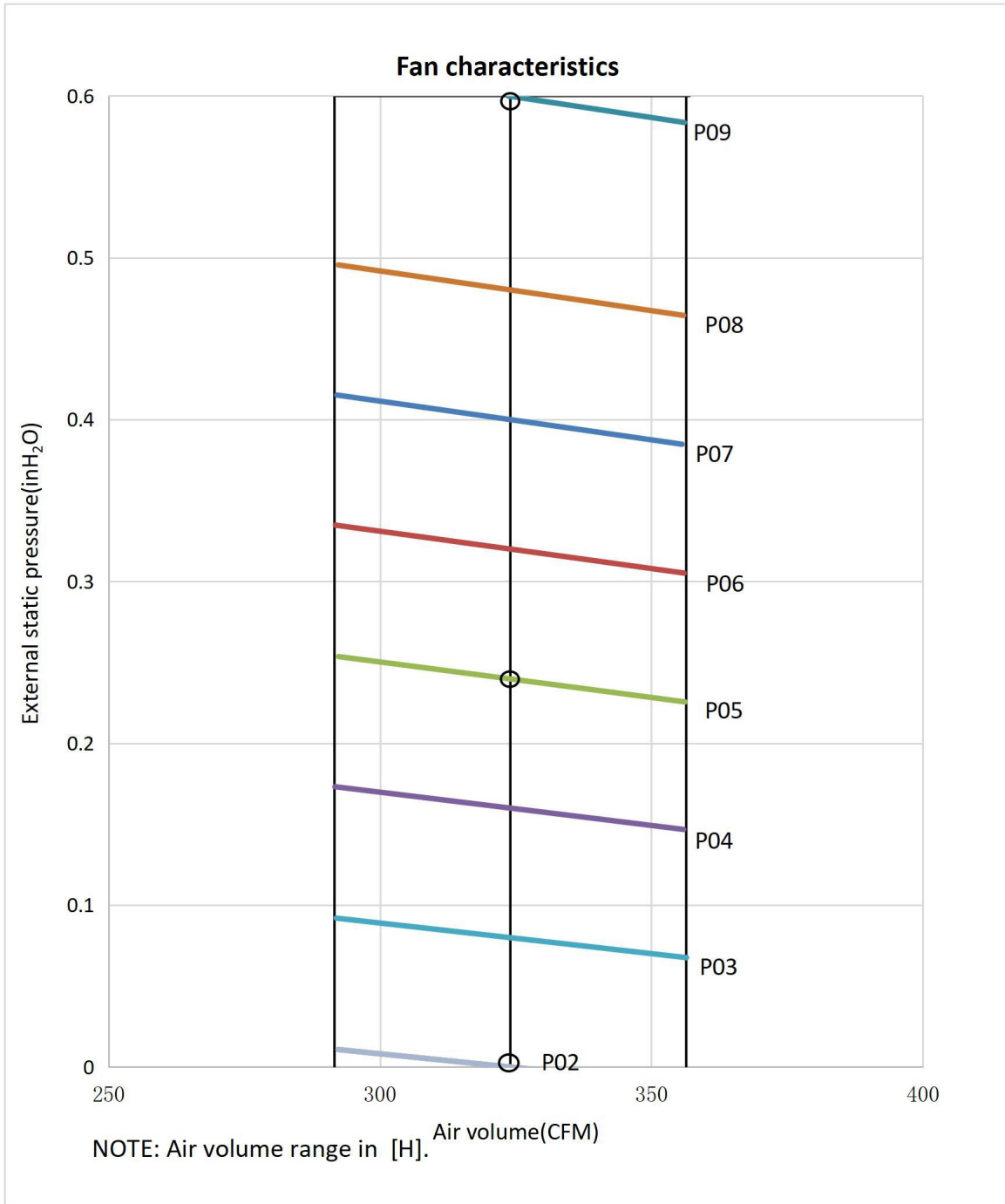

NOTE:

The static pressure is adjusted using the wired controller. Refer to the wired controller instruction manual for more information.

DIMENSIONS

INDOOR UNIT

Unit: inch

DUC09HP230V1R32AH	
DIMENSIONS	
A	29 9/64
B	19 11/16
C	32 43/64
D	11 13/16
E	29 11/16
F	27 9/16
G	27 9/16

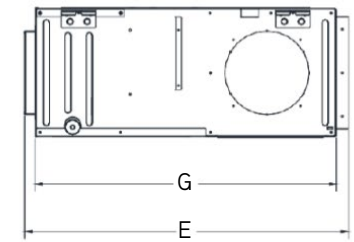
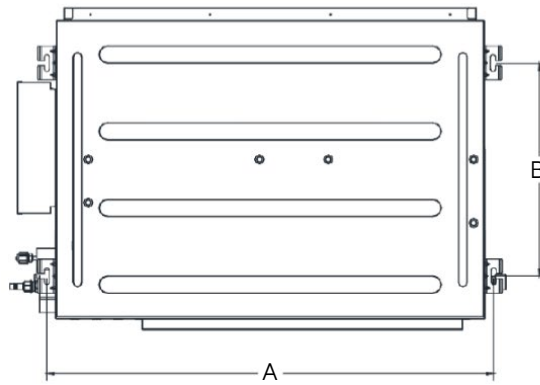
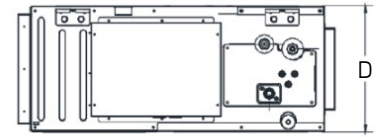
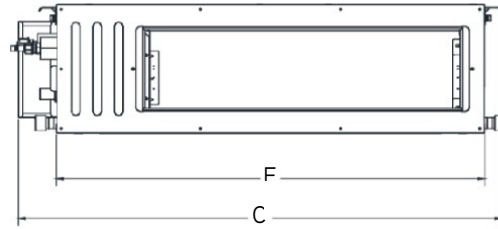

OUTDOOR UNIT

Unit: inch

VIR09HP230V1R32AO	
DIMENSIONS	
A	29 21/64
B	31 37/64
C	21 27/32
D	11 13/16
E	13 25/32
F	20 5/32
G	13 5/64

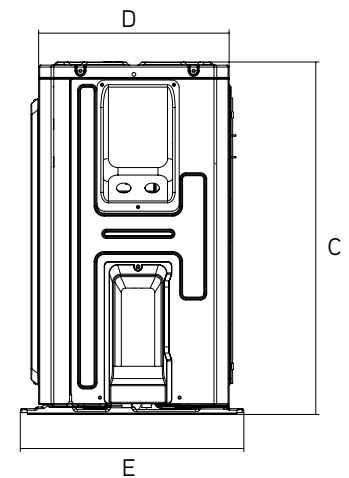
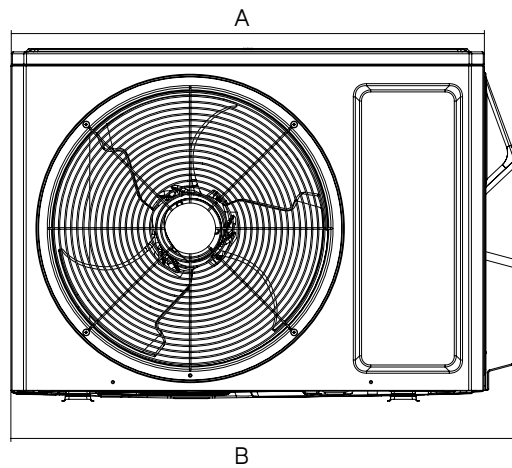

ENV09HP230V1R32AO	
DIMENSIONS	
A	29 21/64
B	31 37/64
C	21 27/32
D	11 13/16
E	13 25/32
F	20 5/32
G	13 5/64

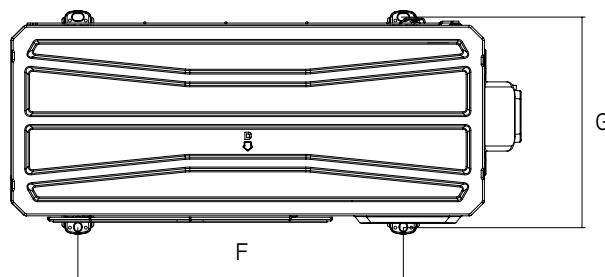

SAP09HP230V1R32AO	
DIMENSIONS	
A	31 11/16
B	34 3/8
C	21 27/32
D	13 1/64
E	14 51/64
F	20 25/32
G	13 21/32

SUPPLY AND RETURN AIR OPENING DIMENSIONS

SUPPLY AIR OUTLET

Unit: inch

DUC09HP230V1R32AH	
DIMENSIONS	
A	7-5/8
B	17-3/4
C	1

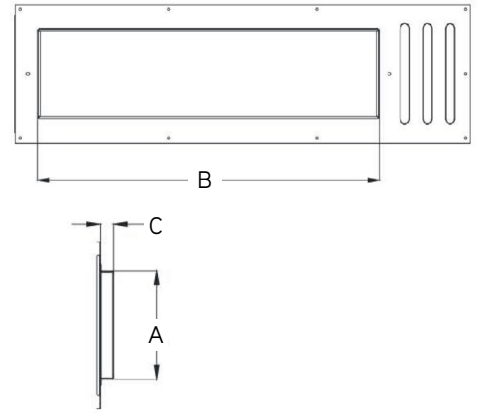
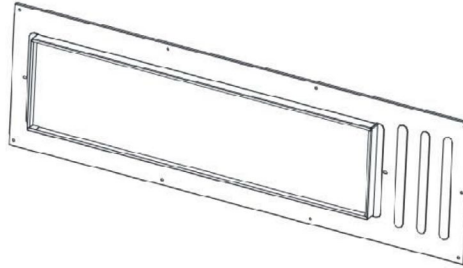

RETURN AIR INLET

Unit: inch

DUC09HP230V1R32AH	
DIMENSIONS	
D	10-3/8
E	26
F	1-1/8

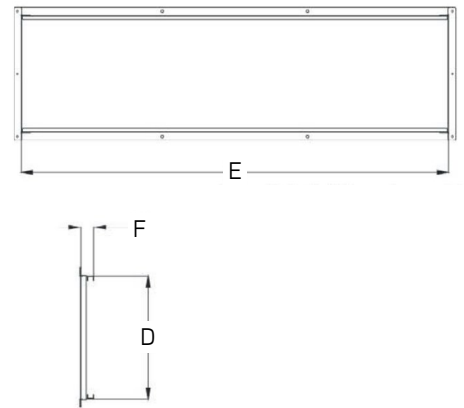
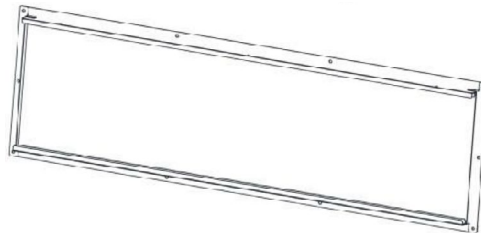

CLEARANCES

INDOOR UNIT

Minimum clearance

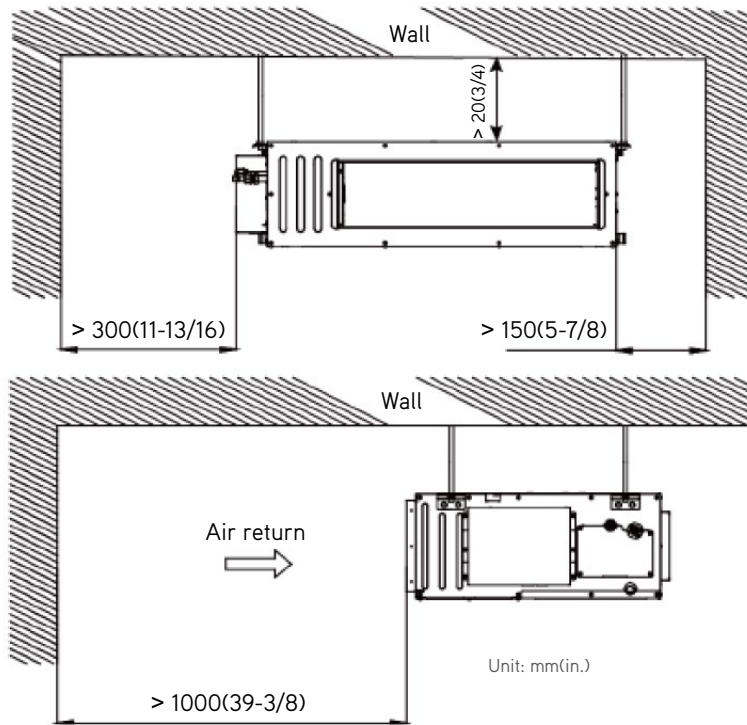

OUTDOOR UNIT

Minimum clearance

NOTE:
If bottom of the unit is free of airflow obstructions similar to the mounting bracket figure, the clearance to the wall on the back can be reduced to 3 inches.

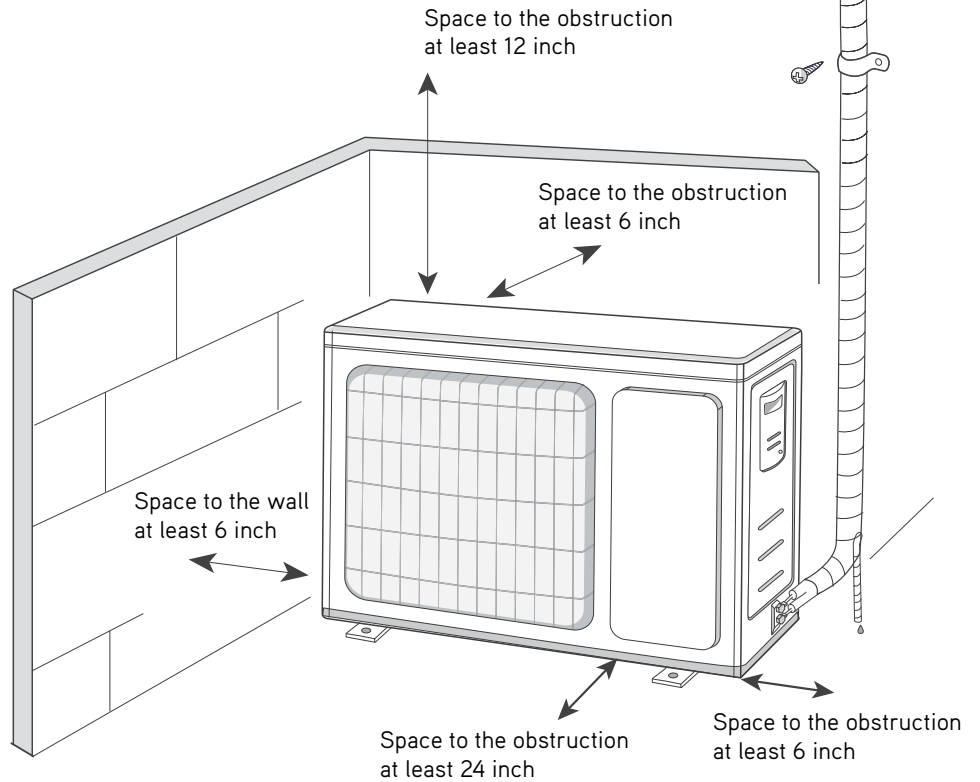

Specifications are subject to change without notice. Manufacturer reserves the right to discontinue or modify specifications or designs without notice or without incurring obligations. All Rights reserved.