



ALL-MATCH INVERTER SERIES_R32

Service Manual

DUC09HP230V1R32AH

DUC12HP230V1R32AH

DUC18HP230V1R32AH

DUC20HP230V1R32AH

GREE ELECTRIC APPLIANCES, INC. OF ZHUHAI

The bottom right corner of the cover features a decorative graphic. It includes a teal triangle, a blue triangle, and a photograph of industrial machinery with complex piping and metal structures, overlaid with a semi-transparent circuit board pattern.

Table of Contents

Part I : Technical Information	1
1. Summary	1
2. Specifications	2
3. Outline Dimension Diagram	5
4. Refrigerant System Diagram	6
5. Electrical Part	7
5.1 Wiring Diagram	7
5.2 PCB Printed Diagram	8
6. Function and Control	9
6.1 Wired Controller Introduction for XE72-44/E.....	9
6.2 Brief Description of Models and Functions	27
Part II : Installation and Maintenance	28
7. Notes for Installation and Maintenance	28
8. Installation Manual	35
8.1 Preparations for Installation.....	36
8.2 Location for Installation.....	36
8.3 Wiring Requirements	37
9. Installation Instructions	38
9.1 Suspend the indoor unit	38
9.2 Refrigerant Pipe Connection.....	39
9.3 Drainage Pipe Installation and Drainage System Testing	39
9.4 Installation of Air Duct.....	42
9.5 Installation of Wired Controller	44
9.6 Wiring Work.....	44
9.7 Adjust after installation	46
9.8 Installation and Dismantlement(Wired Controller).....	46

10. Maintenance..... 50





 10.1 Error Code List.....50

 10.2 Troubleshooting for Main Malfunction.....55

 10.3 Maintenance Method for Normal Malfunction57

11. Exploded View and Parts List 59

12. Removal Procedure..... 63

Symbol	Explanation
	<p>This symbol shows that this appliance uses a flammable refrigerant. If the refrigerant is leaked and exposed to an external ignition source, there is a risk of fire. Appliance filled with flammable magas R32</p>
	<p>This symbol shows that the operation manual should be read carefully.</p>
	<p>This symbol shows that information is available such as the operating manual or installation manual.</p>
	<p>This symbol shows that a service personnel should be handling this equipment with reference to the installation manual.</p>

1. Summary

Indoor Unit:

DUC09HP230V1R32AH
DUC12HP230V1R32AH

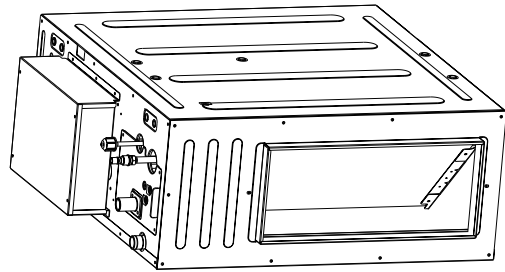

DUC18HP230V1R32AH
GFH(21)DB-D6DNA1A/I
DUC24HP230V1R32AH

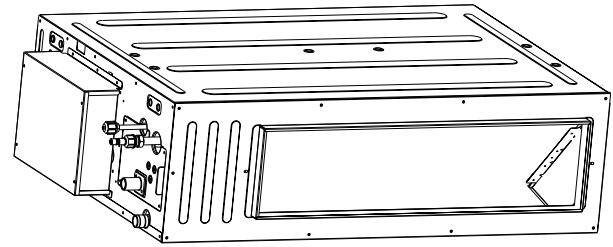

Model list:

No.	Model	Product code	Wired Controller
1	DUC09HP230V1R32AH	CN210N0380	XE72-44/E
2	DUC12HP230V1R32AH	CN210N0390	
3	DUC18HP230V1R32AH	CN210N0400	
4	GFH(21)DB-D6DNA1A/I	CN210N0410	
5	DUC24HP230V1R32AH	CN210N0420	

Wired Controller:

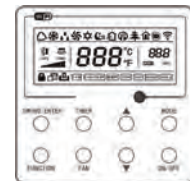

Model	--	DUC18HP230V1R32AH	GFH(21)DB-D6DNA1A/I
Product Code	--	CN210N0400	CN210N0410
Power Supply	Rated Voltage	V~	208/230
	Rated Frequency	Hz	60
	Phases	--	1
Cooling Capacity	Btu/h	18000	22000
Heating Capacity	Btu/h	18000	24000
Cooling Power Input	KW	0.161	0.161
Heating Power Input	KW	0.161	0.161
Cooling Current Input	A	0.7	0.7
Heating Current Input	A	0.7	0.7
Air flow volume	CFM	589/412/312/288	589/412/312/288
Dehumidifying Volume	Pint/h	3.8	4.23
Fan Type	--	Centrifugal	Centrifugal
Fan Quantity	--	2	2
Fan Diameter-height	mm	Φ202-107	Φ202-107
Cooling Speed	r/min	990/700/700/530/530/490/490	990/700/700/530/530/490/490
Heating Speed	r/min	990/700/700/530/530/490/490	990/700/700/530/530/490/490
Fan Motor Power Output	W	200	200
Fan Motor Power Input	W	/	/
Motor Full Load Amp(FLA)	A	1.1	1.1
Fan Motor Capacitor	μF	/	/
Evaporator Material	--	Copper tube-Aluminum fin	Copper tube-Aluminum fin
Evaporator Pipe Diameter	mm	Φ7.94	Φ7.94
Evaporator Number of Rows-Fin Pitch	mm	3-1.8	3-1.8
Evaporator Length(L) xHeight(H) x Width(W)	mm	753x308x57.2	753x308x57.2
Fuse Current	A	5	5
Sound Pressure Level	dB (A)	40/32/26/25	41/32/26/25
Sound Power Level	dB (A)	50/42/36/35	51/42/36/35
Dimension of Outline(WXDXH)	inch	44 31/64 X 29 11/16 X 11 13/16	44 31/64 X 29 11/16 X 11 13/16
Dimension of Carton Box(LXWXH)	inch	47 21/64X37 57/64X13 37/64	47 21/64X37 57/64X13 37/64
Dimension of Package(LXWXH)	inch	47 7/16X32 1/64X14 11/64	47 7/16X32 1/64X14 11/64
Net Weight	lb	92.61	92.61
Gross Weight	lb	106.94	106.94
Liquid pipe	--	1/4"	1/4"
Gas Pipe(to indoor unit)	--	5/8"	5/8"
Drain Connection (outer diameter)	mm	Φ25	Φ25

The above data is subject to change without notice. Please refer to the nameplate of the unit.

Model	--	DUC24HP230V1R32AH
Product Code	--	CN210N0420
Power Supply	Rated Voltage	V~ 208/230
	Rated Frequency	Hz 60
	Phases	-- 1
Cooling Capacity	Btu/h	22000
Heating Capacity	Btu/h	24000
Cooling Power Input	KW	0.207
Heating Power Input	KW	0.207
Cooling Current Input	A	0.9
Heating Current Input	A	0.9
Air flow volume	CFM	736/559/453/406
Dehumidifying Volume	Pint/h	5.28
Fan Type	--	Centrifugal
Fan Quantity	--	2
Fan Diameter-height	mm	Φ202-107
Cooling Speed	r/min	1050/730/730/650/650/580/580
Heating Speed	r/min	1050/730/730/650/650/580/580
Fan Motor Power Output	W	200
Fan Motor Power Input	W	/
Motor Full Load Amp(FLA)	A	1.3
Fan Motor Capacitor	μF	/
Evaporator Material	--	Copper tube-Aluminum fin
Evaporator Pipe Diameter	mm	Φ7.94
Evaporator Number of Rows-Fin Pitch	mm	3-1.8
Evaporator Length(L) ×Height(H) × Width(W)	mm	753×308×57.2
Fuse Current	A	5
Sound Pressure Level	dB (A)	42/34/33/30
Sound Power Level	dB (A)	52/44/43/40
Dimension of Outline(WXDXH)	inch	44 31/64 X 29 11/16 X 11 13/16
Dimension of Carton Box(LXWXH)	inch	47 21/64X37 57/64X13 37/64
Dimension of Package(LXWXH)	inch	47 7/16X32 1/64X14 11/64
Net Weight	lb	92.61
Gross Weight	lb	106.94
Liquid pipe	--	1/4"
Gas Pipe(to indoor unit)	--	5/8"
Drain Connection (outer diameter)	mm	Φ25

The above data is subject to change without notice. Please refer to the nameplate of the unit.

3. Outline Dimension Diagram

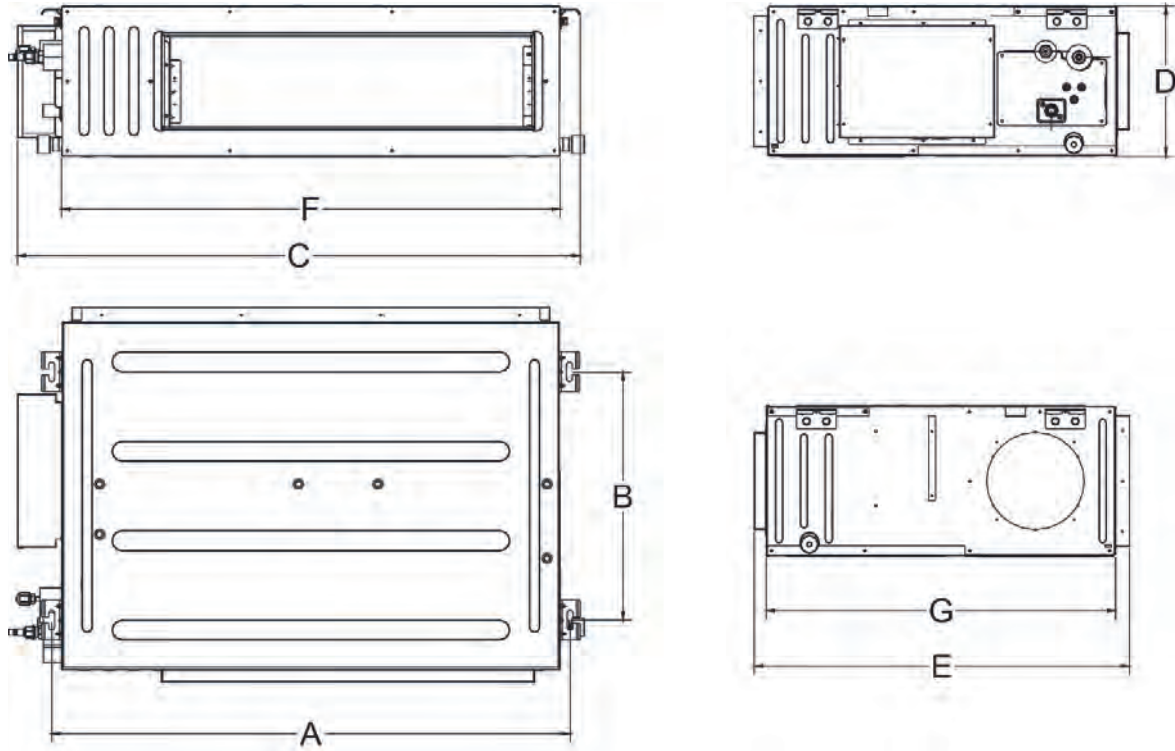

Unit:inch

Model	A	B	C	D	E	F	G
09/12K	29 9/64	19 11/16	32 43/64	11 13/16	29 11/16	27 9/16	27 9/16
18/21/24K	40 15/16	19 11/16	44 31/64	11 13/16	29 11/16	39 3/8	27 9/16

4. Refrigerant System Diagram

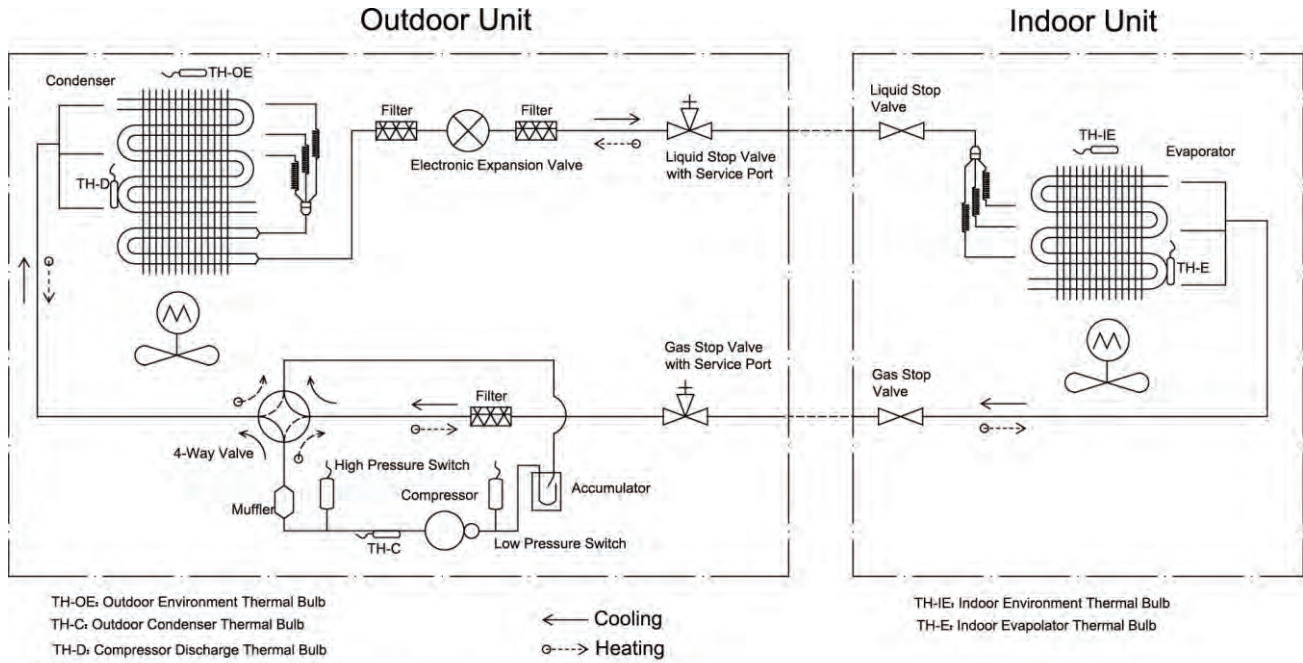

TH-OE: Outdoor Environment Thermal Bulb
 TH-C: Outdoor Condenser Thermal Bulb
 TH-D: Compressor Discharge Thermal Bulb

TH-IE: Indoor Environment Thermal Bulb
 TH-E: Indoor Evaporator Thermal Bulb

Note:
 1. it is just a schematic diagram and some parts may differ from the real objects inside the unit.

5. Electrical Part

5.1 Wiring Diagram

•Instruction

Symbol	Symbol Color	Symbol	Symbol Color	Symbol	Name
WH	White	GN	Green	CAP	Jumper cap
YE	Yellow	BN	Brown	COMP	Compressor
RD	Red	BU	Blue		Grounding wire
YEGN	Yellow/Green	BK	Black	/	/
VT	Violet	OG	Orange	/	/

Note: Jumper cap is used to determine fan speed and the swing angle of horizontal lover for this model.

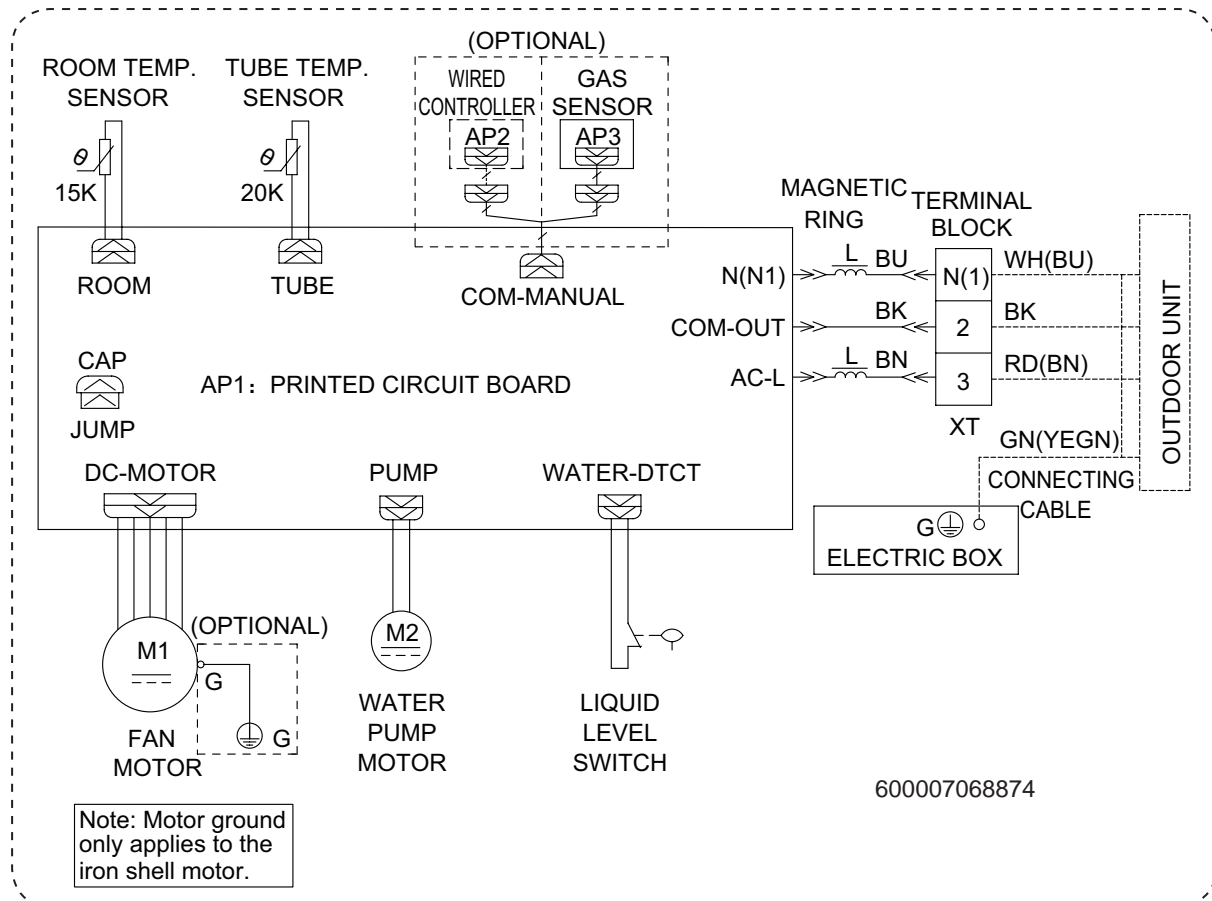

These wiring diagrams are subject to change without notice; please refer to the one supplied with the unit.

5.2 PCB Printed Diagram

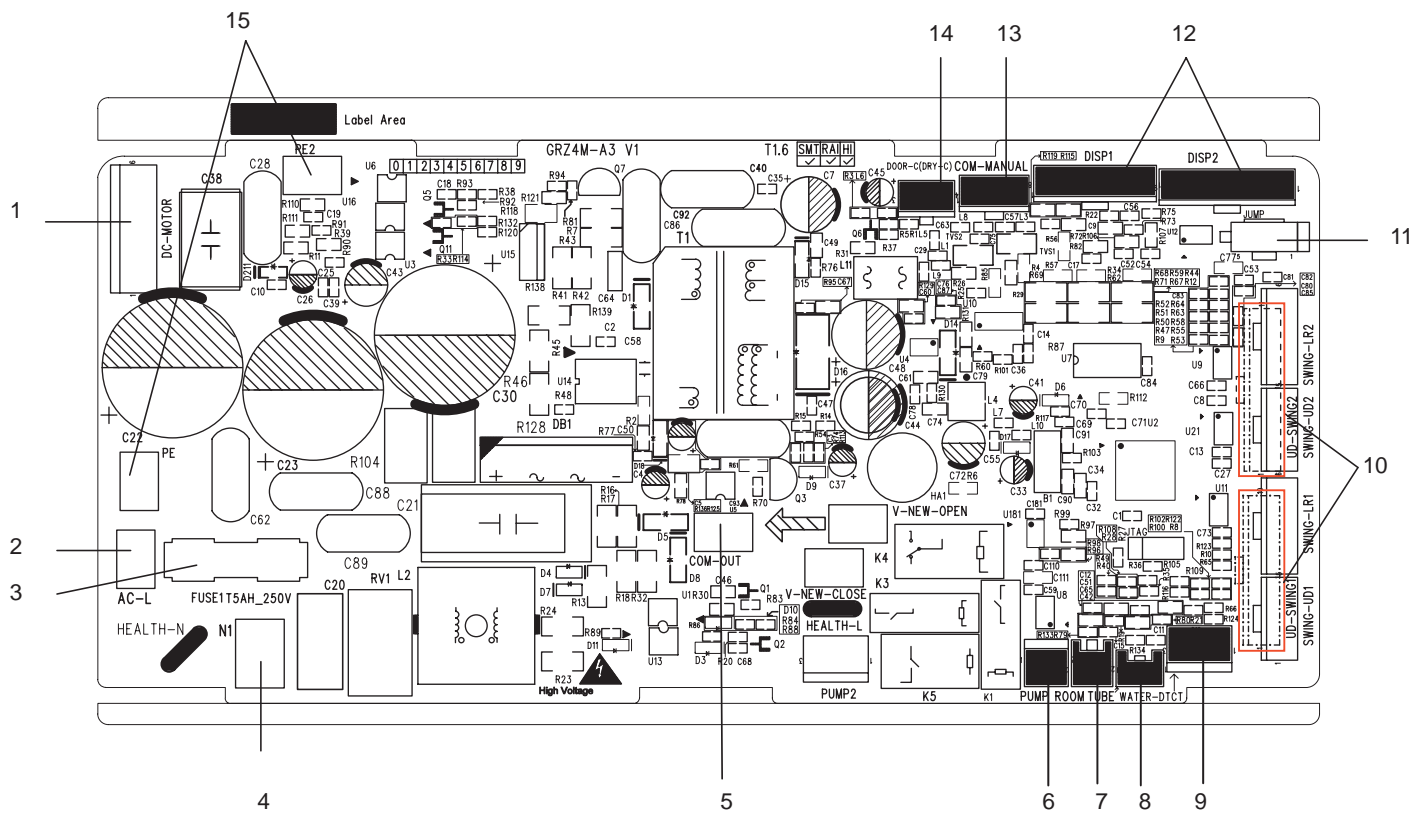

No.	Name
1	Interface of fan
2	Interface of live wire
3	Fuse
4	Interface of neutral wire
5	Terminal with outdoor unit communication wire
6	Water pump control
7	Interface of ambient temperature sensor
8	Interface of tube temperature sensor

No.	Name
9	Water full detection terminal
10	Up&down swing terminal
11	Jumper cap terminal
12	Display interface
13	Wired controller
14	Interface of gate-control detection
15	Grounding wire

6. Function and Control

6.1 Wired Controller Introduction for XE72-44/E

1 Symbols on LCD

1.1 Outside View of the Wired Controller

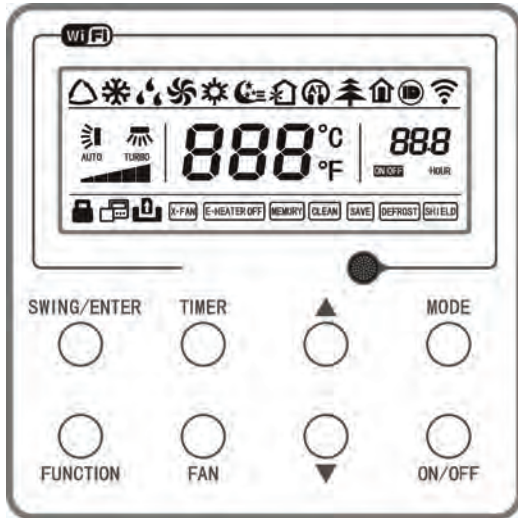

Fig.1 Outside View of the Wired Controller

1.2 LCD of the Wired Controller

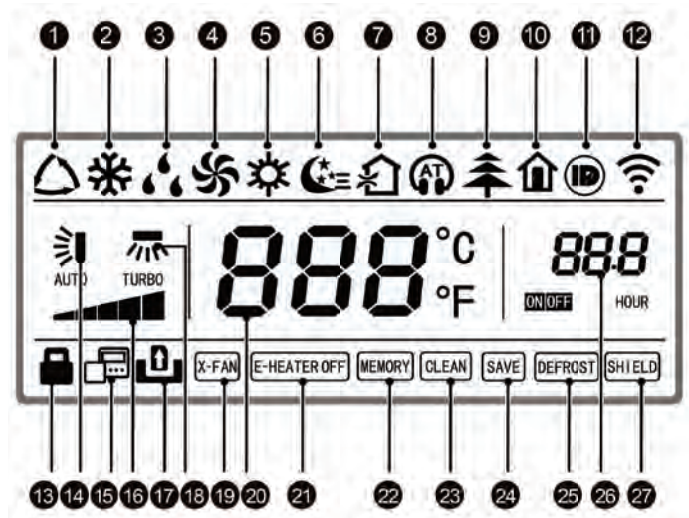

Fig.2 LCD of the Wired Controller

Table 1

No.	Display	Instruction of Display	No.	Display	Instruction of Display
1	Auto	Automatic mode (under auto mode, the indoor unit will select its operating mode according to the variation of room temperature)	15	Slave wired controller	Icon of slave wired controller, it will display when slave wired controller is set (this function is unavailable for this unit)
2	Cool	Cooling mode	16	Fan speed	The fan speed set currently (including auto, low, medium low, medium, medium high, high, and turbo)
3	Dry	Dry mode	17	No card	No card in gate control system
4	Fan	Fan mode	18	Left & right swing	Display when left and right swing function is set
5	Heat	Heating mode	19	X-fan	Display when X-fan function is set
6	Sleep	Display when sleep function is set	20	Temperature	It will display the setting temperature
7	Fresh air	Display when fresh air function is set	21	E-heater	On/off switch of auxiliary heating
8	Quiet	Display when quiet function is set	22	Memory	Memory status (After power failure and reenergizing the unit, it will resume to ON/OFF status of unit before the power failure)
9	Health	Display when health function is set	23	Clean	Filter washing reminder (this function is unavailable for this unit)
10	Absent	Display when absent function is set	24	Save	Display when energy-saving function is set
11	I-DEMAND	Display when I-DEMAND function is set	25	Defrost	Defrosting status
12	WiFi	Display when WiFi function is set	26	Defrost	Display when timer status is set
13	Child-lock	Child-lock status, display when child-lock function is set	27	Shield	Shielding status
14	Up & down swing	Display when up and down swing function is set			

2 Buttons

2.1 Buttons on the Wired Controller

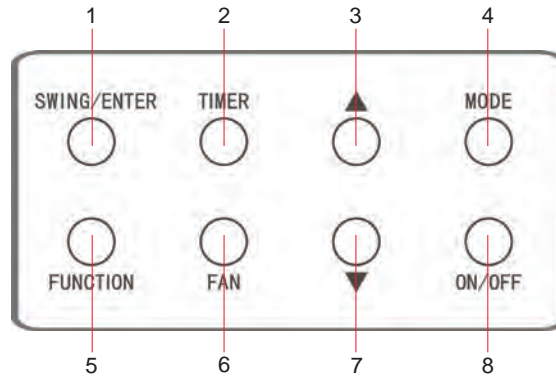

Fig. 3 Buttons on the Wired Controller

2.2 Function of the Buttons

Table 2

No.	Name	Function
1	SWING/ENTER	1. Function selection and cancellation. 2. Setting of the up and down swing function.
3	▲	1. Running temperature setting of the indoor unit, range: 61~86°F(16~30°C). 2. Timer setting, range: 0.5-24 hr.
7	▼	
6	FAN	Setting of the auto/low/medium low/medium/high fan speed.
4	MODE	Setting of the Cooling/Heating/Fan/Dry/Auto mode of the indoor unit.
5	FUNCTION	Switchover among the functions of Turbo/WiFi/E-heater/X-fan etc..
2	TIMER	TIMER setting.
8	ON/OFF	Turn on/off the indoor unit.
3+4	▲+MODE	Press them for 5s under off state of the unit to Enter/Cancel the Memory function(If memory is set, indoor unit after power failure and then power recovery will resume the original setting state. If not, the indoor unit is defaulted to be off after power recovery. Memory off is default before delivery.).
6+7	FAN+▼	By pressing them at the same time under off state of the unit, ❄ will be displayed on the wired controller for the cooling only unit, while ❄ will be displayed on the wired controller for the cooling and heating unit.
3+7	▲+▼	Upon startup of the unit without malfunction or under off state of the unit, press them at the same time for 5s to enter the lock state, in which case, any other buttons won't respond the press. Repress them for 5 seconds to quit this state.
4+7	MODE+▼	Under OFF state, the Celsius and Fahrenheit scales can be switched by pressing "MODE" and "▼" for 5s.
2+5	TIMER+FUNCTION	Under OFF state, it is available to go to the commissioning status by pressing "FUNCTION" and "TIMER" for five seconds, and let "00" displayed on the temperature display area by pressing "MODE", then adjust the options which is shown on the timer area by pressing "▲" and "▼". There are totally four options, as follows: 1. Indoor ambient temperature is sensed by the return air temperature sensor (01 displayed on the timer area). 2. Indoor ambient temperature is sensed by the wired controller (02 displayed on the timer area). 3. The return air temperature sensor is selected under the cooling, dry, or fan mode; while the wired controller temperature sensor is selected under the heating or auto mode. (03 is displayed on the timer area). 4. The wired controller temperature sensor is selected under the cooling, dry, or fan mode; while the return air temperature sensor is selected under the heating mode. (04 is displayed on the timer display area).
2+5	TIMER+FUNCTION	Under OFF state, it is available to go to the commissioning status by pressing "FUNCTION" and "TIMER" for five seconds. Press "MODE" button to until "01" icon is shown at the temperature display area. The setting status will be shown at timer area. Press "▲" and "▼" button to adjust and two options are available: 1. Three low levels (01); 2. Three high levels (02).
5+6	FUNCTION+FAN	Reset the WiFi function: Under off status, press "FUNCTION" + "FAN" combination buttons on its wired controller for 5s. Once "C" is displayed, this indicates that reset was successful.

3 Operation Instructions

3.1 ON/OFF

Press ON/OFF to turn on the unit and turn it off by another press.

NOTE: The state shown in Fig.4 indicates the "OFF" state of the unit after power on. The state shown in Fig.5 indicates the "ON" state of the unit after power on.

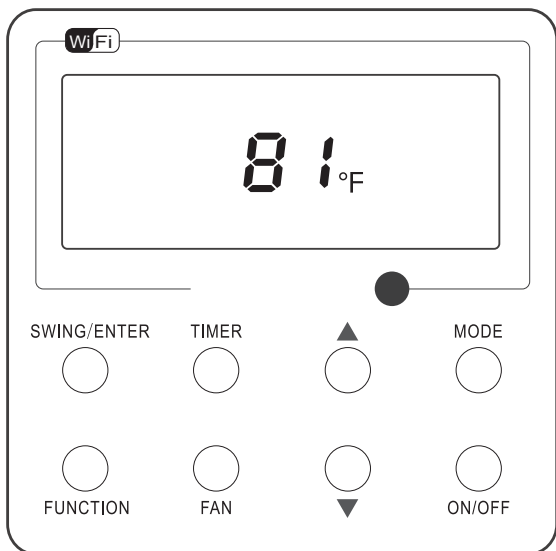

Fig. 4 "OFF" State

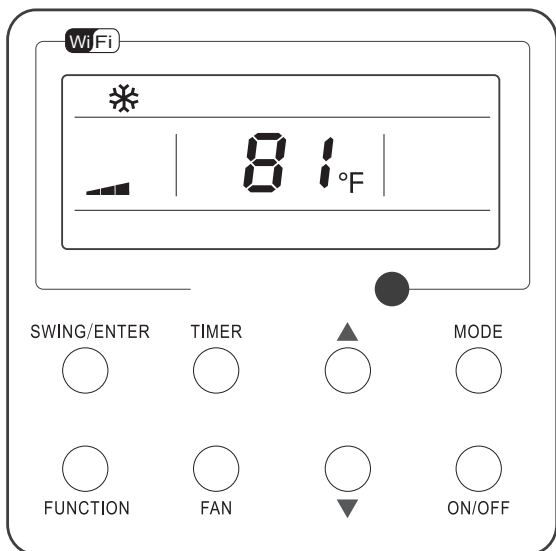
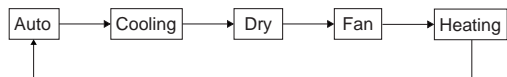

Fig. 5 "ON" State

3.2 Mode Setting

Under the "ON" state of the unit, press MODE to switch the operation modes as the following sequence: Auto-Cooling-Dry-Fan-Heating.



3.3 Temperature Setting

Press ▲ or ▼ to increase/decrease the preset temperature. If press either of them continuously, the temperature will be increased or decreased by 1°C(1°F) every 0.5s, as shown in Fig.6.

In the Cooling, Dry, Fan or Heating mode, the temperature setting range is 16°C~30°C(61°F~86°F).

In the Auto mode, the setting temperature is unadjustable.

NOTE: If the wired controller receives the signals of remote controller, the wired controller can analyze the set temperature adjustment function of automatic mode of the remote controller, but it needs to be used with an indoor unit with the set temperature adjustment function of automatic mode.

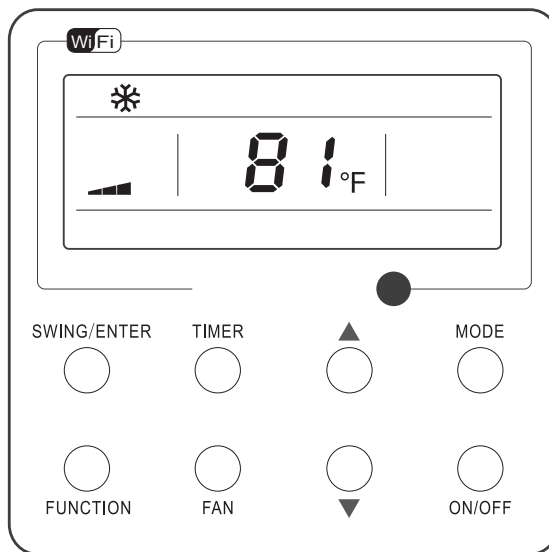

Fig. 6

3.4 Fan Setting

Under the "ON" State of the unit, press Fan and then fan speed of the indoor unit will change circularly as shown in Fig.7.

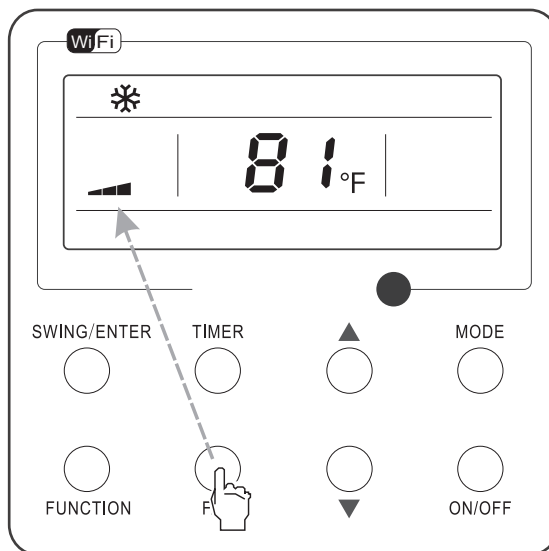
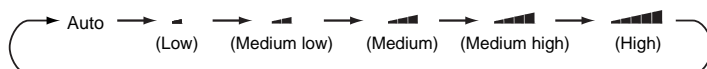



Fig. 7

3.7 Left & Right Swing Setting

- Swing On: Press FUNCTION under on state of the unit to activate the swing function. In this case,  will blink. After that, press SWING/ENTER to make a confirmation.
- Swing Off: When the Swing function is on, press FUNCTION to enter the Swing setting interface, with  blinking. After that, press SWING/ENTER to cancel this function.

Swing setting is shown as Fig.9.

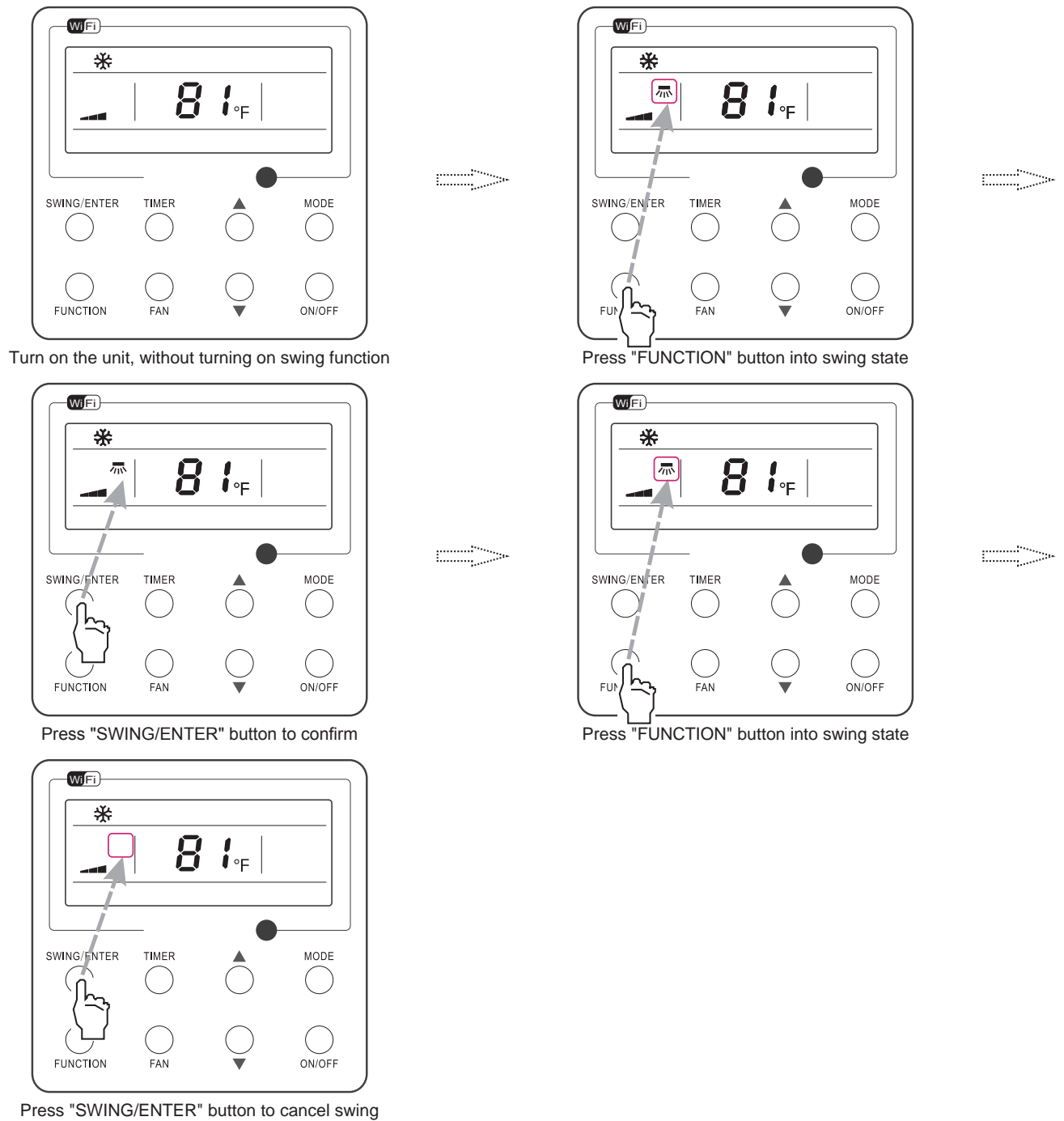



Fig. 9 Swing Setting

- NOTE:**
1. Sleep, Turbo or X-fan setting is the same as the Swing setting.
 2. After the setting has been done, it has to press the key "SWING/ENTER" to back to the setting status or quit automatically five seconds later.

3.8 Fresh Air Valve Function Setting

- Turn on fresh air valve function:

Under unit on status, press FUNCTION button on the panel to select "Fresh air valve" function option. When  icon flashes, it enters fresh air valve setting mode. Previous temperature display position will display the level of fresh air valve. Press ▲ or ▼ button to adjust the level of fresh air valve within the range from 1 to 10. Then press SWING/ENTER button to activate this function.

- Turn off fresh air valve function:

If fresh air valve function has been set, press FUNCTION button on the panel to select "Fresh air valve" function option. When icon  flashes, if you press SWING/ENTER button without pressing ▲ or ▼ button, fresh air valve function will be canceled; if you press SWING/ENTER button after pressing ▲ or ▼ button, fresh air valve function will be activated.

NOTE:

1. If you press panel button to set fresh air valve function on, ventilation (ventilation 1) function will be activated too; if you press panel button to set fresh air valve function off, ventilation function will be canceled too.
2. This function is invalid when working with the model with two-way ventilation system.

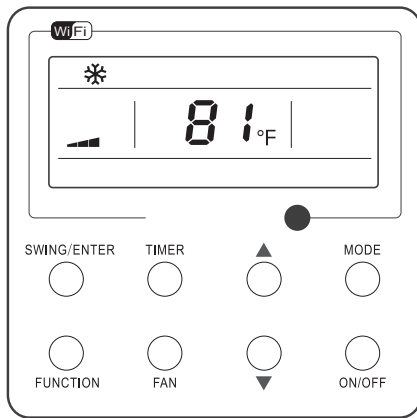

Turn on the unit with the "Fresh Air" function deactivated

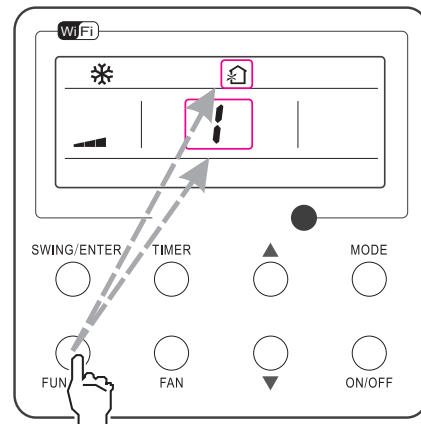

Press "FUNCTION" button to select the "Fresh Air" function option

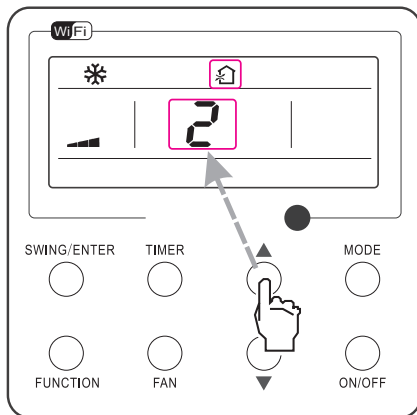

Press ▲ or ▼ to adjust the "Fresh Air" type

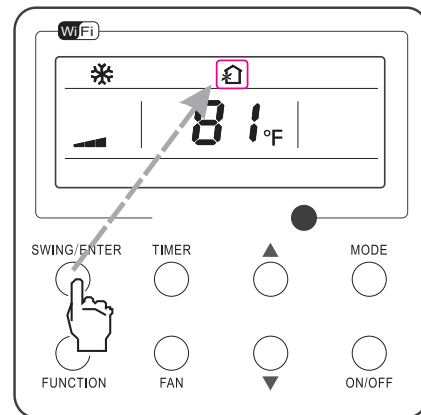

Press "SWING/ENTER" button to activate the "Fresh Air" function

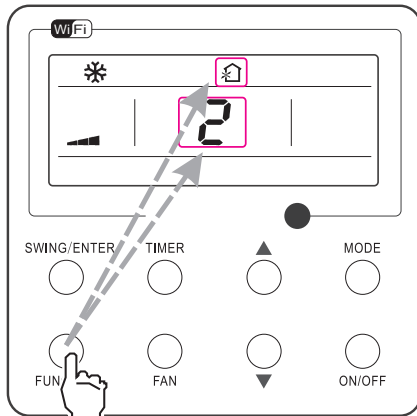

Press "FUNCTION" button to select the "Fresh Air" function option

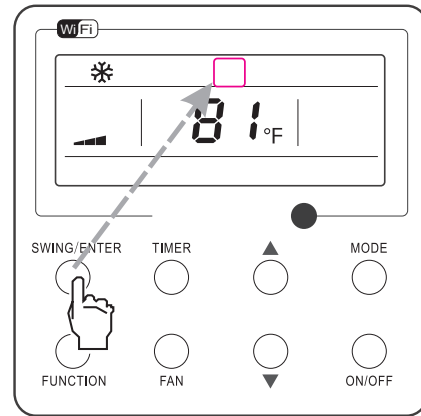

Press "SWING/ENTER" button to deactivate the "Fresh Air" function

Fig. 10 Fresh Air Valve Function Setting

3.9 Sleep Setting

- Sleep on: Press FUNCTION under on state of the unit till the unit enters the Sleep setting interface. Press SWING/ENTER to confirm the setting.
- Sleep off: When the Sleep function is activated, press FUNCTION to enter the Sleep setting interface. After that, press SWING/ENTER to can this function.

Sleep setting is shown as Fig.11.

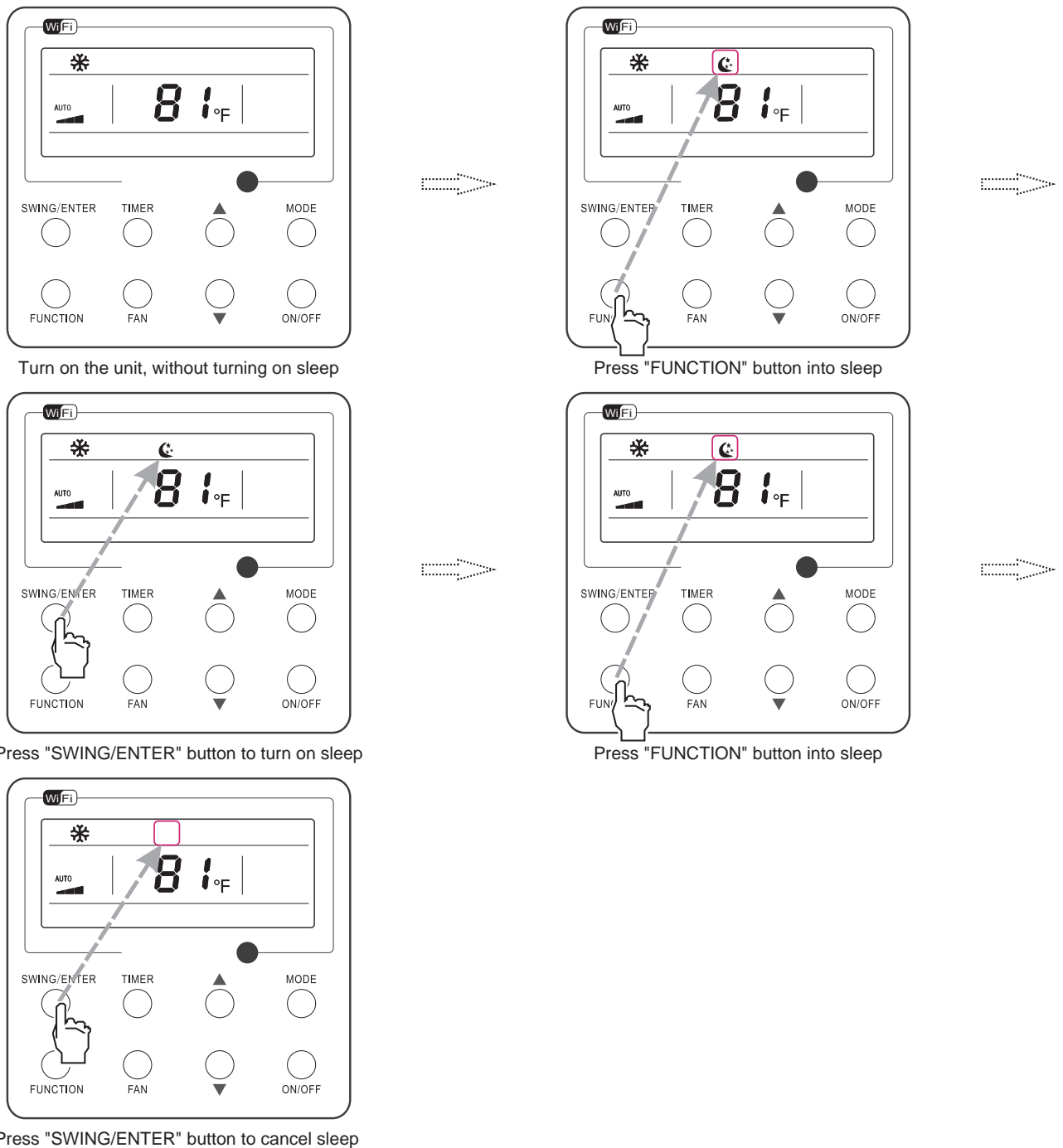

Fig. 11 Sleep Setting

3.10 Turbo Setting

Turbo function: The unit at the high fan speed can realize quick cooling or heating so that the room temperature can quickly approach the setting value.

In the Cooling or Heating mode, press FUNCTION till the unit enters the Turbo setting interface and then press SWING/ENTER to confirm the setting.

When the Turbo function is activated, press FUNCTION to enter the Turbo setting interface and then press SWING/ENTER to cancel this function.

Turbo function setting is as shown in Fig.12.

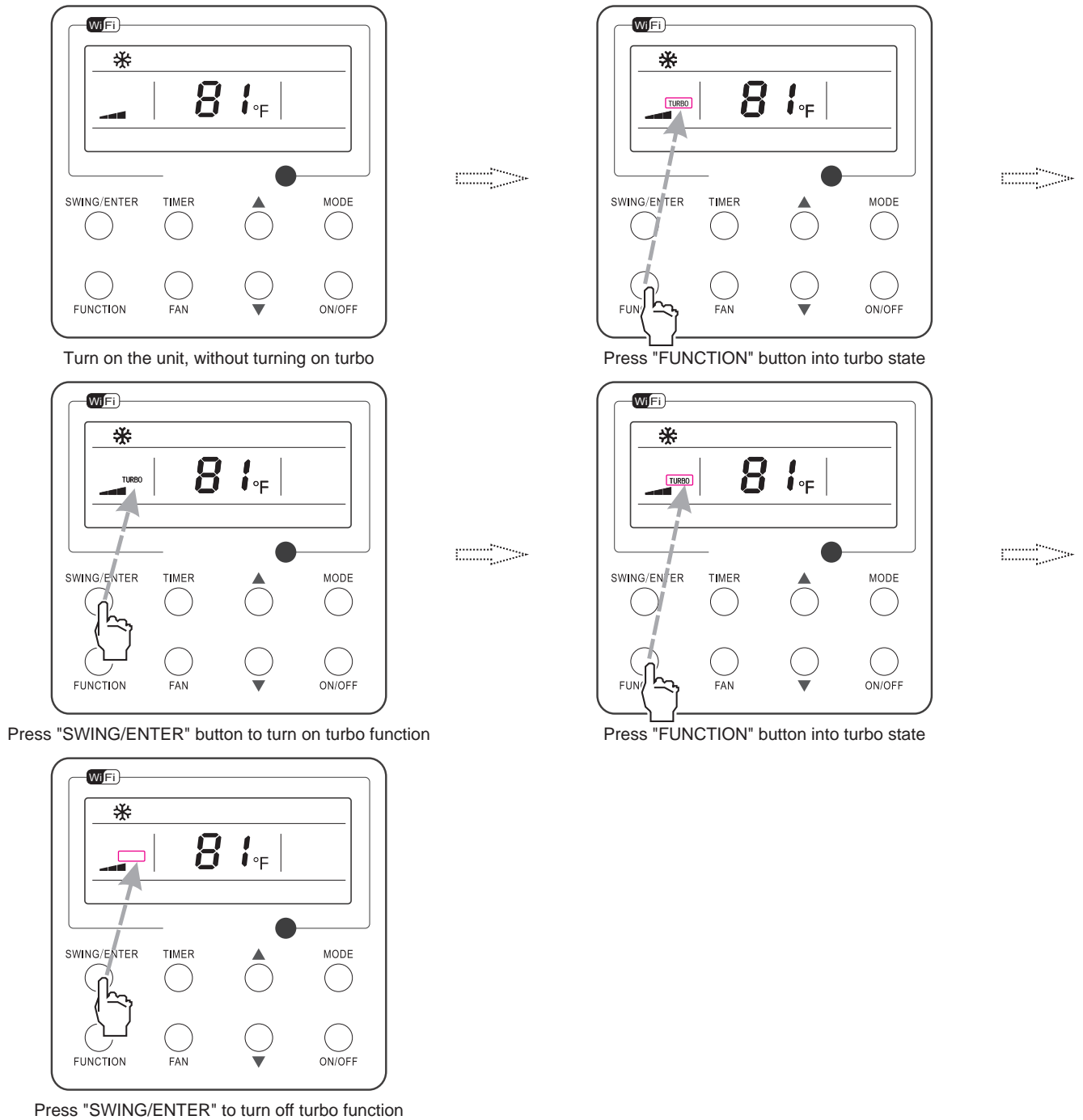

Fig. 12 Turbo Setting

3.11 Energy Saving Function Setting

- Turn on energy saving function:

1. Energy Saving Setting for Cooling

When the unit runs under the COOL or DRY mode, press FUNCTION button to select "SAVE" function option, with "SAVE" flashing, and then press ▲ or ▼ to adjust the lower limit, after that, press the SWING/ENTER button to activate this function.

2. Energy Saving Setting for Heating

When the unit runs under the HEAT mode, press FUNCTION button to select "SAVE" function option, with "SAVE" flashing, and then press ▲ or ▼ to adjust the upper limit, after that, press SWING/ENTER button to activate this function.

NOTE: Under energy saving setting mode, press "MODE" button to switch the energy saving setting for COOL or HEAT mode.

- Cancel energy saving function:

If energy saving function has been set, press FUNCTION button on the panel to select "SAVE" function option. When  icon flashes, if you press SWING/ENTER button without pressing ▲ or ▼ button, energy saving function will be canceled; if you press SWING/ENTER button after pressing ▲ or ▼ button, energy saving function will be activated.

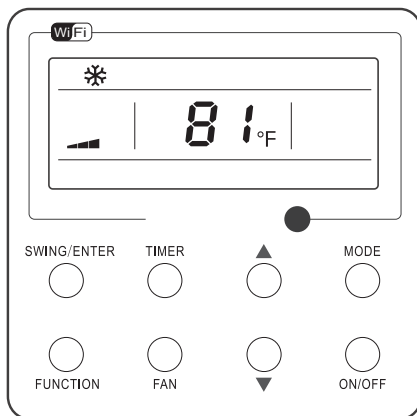

Turn on the unit with the "SAVE" function deactivated

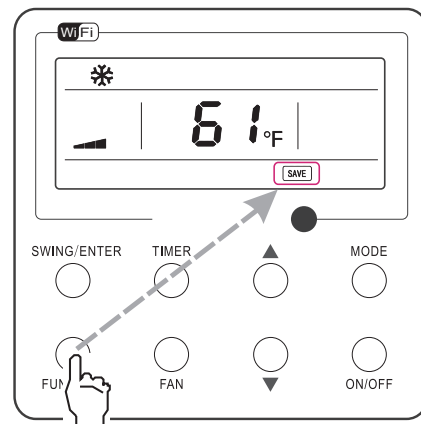

Press "FUNCTION" button to select the "SAVE" function option

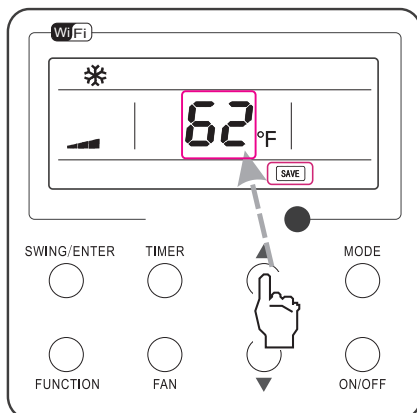

Press ▲ or ▼ to adjust the lower limit

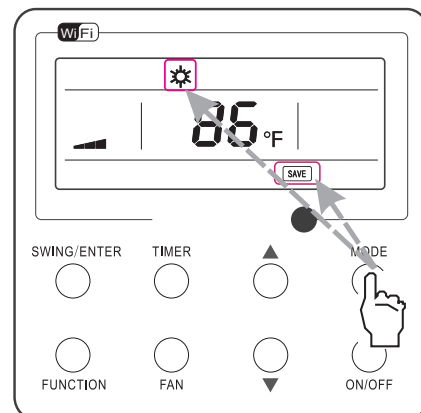

Press "MODE" button to switch to the "SAVE" setting for heating

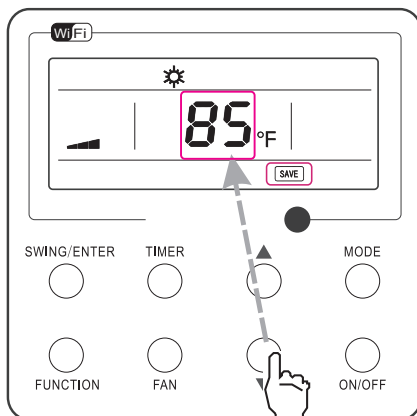

Press ▲ or ▼ to adjust the upper limit

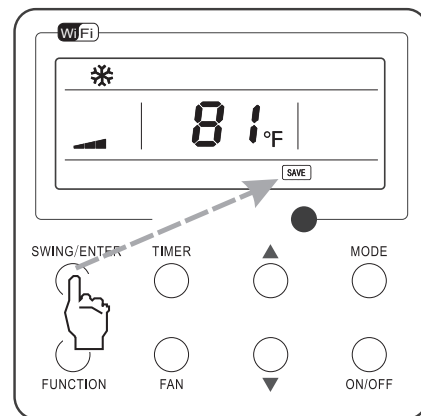

Press "SWING/ENTER" button to activate the "SAVE" function

Fig. 13 Energy Saving Function Setting

3.12 E-heater Setting

E-heater (auxiliary electric heating function): In the Heating mode, E-heater is allowed to be turned on for improvement of efficiency.

Once the wired controller or the remote controller enters the Heating mode, this function will be turned on automatically.

Press FUNCTION in the Heating mode to enter the E-heater setting interface and then press SWING/ENTER to cancel this function.

Press FUNCTION to enter the E-heater setting interface, if the E-heater function is not activated, and then press SWING/ENTER to turn it on.

The setting of this function is shown as Fig.14 below:

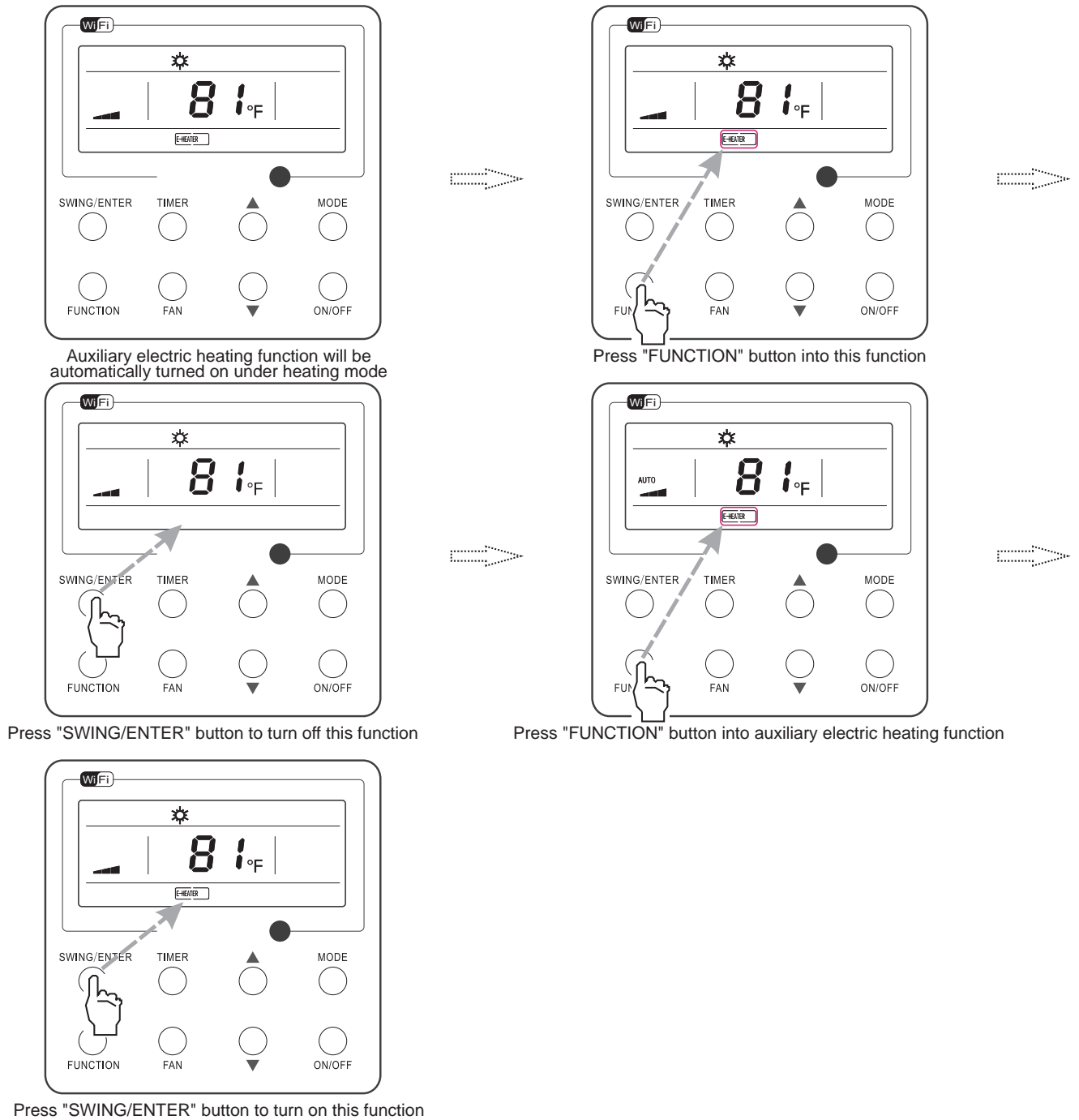

Fig. 14 E-heater Setting

3.13 X-fan Setting

X-fan function: After the unit is turned off, the water in evaporator of indoor unit will be automatically evaporated to avoid mildew.

In the Cooling or Dry mode, press FUNCTION till the unit enters the X-fan setting interface and then press SWING/ENTER to activate this function.

When the X-fan function is activated, press FUNCTION to the X-fan setting interface and then press SWING/ENTER to cancel this function.

X-fan function setting is as shown in Fig.15.

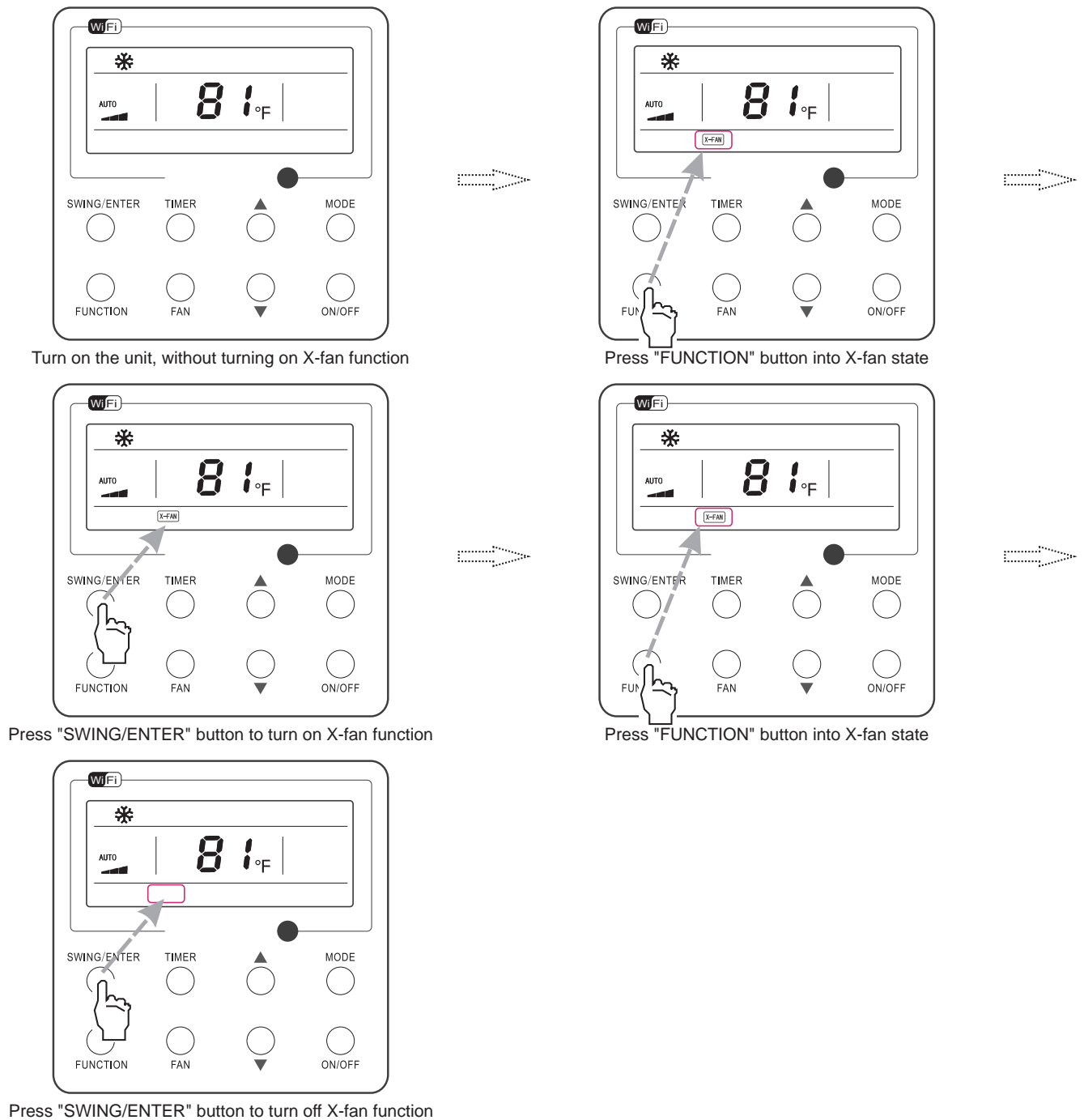

Fig. 15 X-fan Setting

- NOTE:**
1. When the X-fan function is activated, if turning off the unit by pressing ON/OFF or by the remote controller, the indoor fan will run at the low fan speed for 2 minutes, with "X-FAN" displayed on the LCD. While, if the X-fan function is deactivated, the indoor fan will be turned off directly.
 2. X-fan function is unavailable in the Fan or Heating mode.

3.14 Quiet Function Setting

- Turn on quiet function:

Under unit on status, press FUNCTION button on the panel to select "Quiet" function option. When "Quiet" or "Auto quiet" flashes, it enters quiet function setting mode. Press ▲ or ▼ button to switch between "Quiet" and "Auto quiet" function. Then press SWING/ENTER button to activate this function.

- Cancel quiet function:

If quiet function has been set, press FUNCTION button on the panel to select "Quiet" function option. When "Quiet" or "Auto quiet" flashes, if you press SWING/ENTER button without pressing ▲ or ▼ button, quiet function will be canceled; if you press SWING/ENTER button after pressing ▲ or ▼ button, quiet function will be activated.

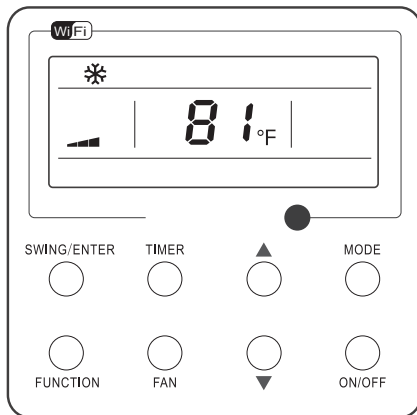

Turn on the unit with the "Quiet" function deactivated

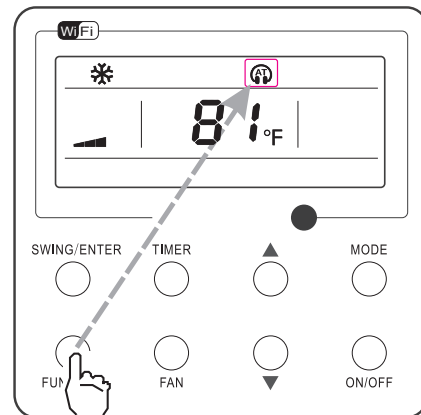

Press "FUNCTION" button to select the "Quiet" function option

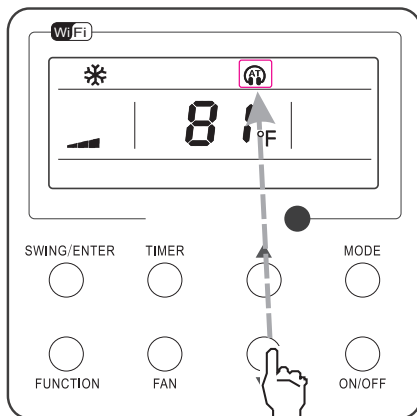

Press ▲ or ▼ to select the desired type, "QUIET" or "AUTO QUIET"

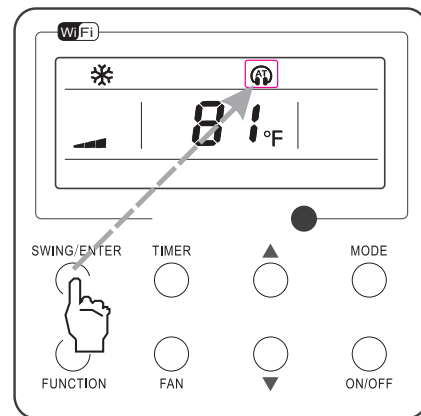

Press "SWING/ENTER" button to activate this function

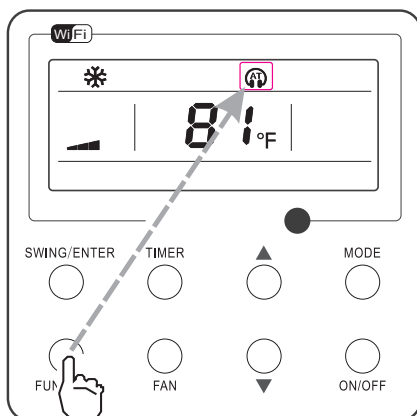

Press the Function button to select the "Quiet" function option

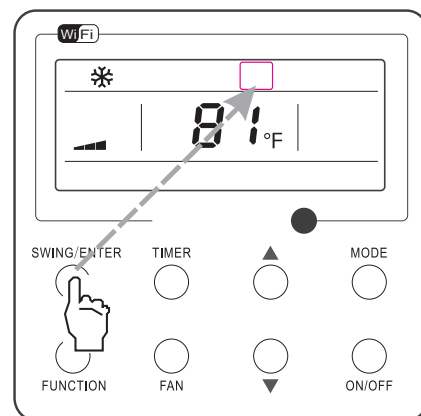

Press "SWING/ENTER" button to deactivate this function

Fig. 16 Setting of Quiet Function

3.15 Health Setting

- Health on: Press FUNCTION under on state of the unit till the unit enters the Health setting interface. Press SWING/ENTER to confirm the setting.
- Health off: When the Health function is activated, press FUNCTION to enter the Health setting interface. After that, press SWING/ENTER to cancel this function.

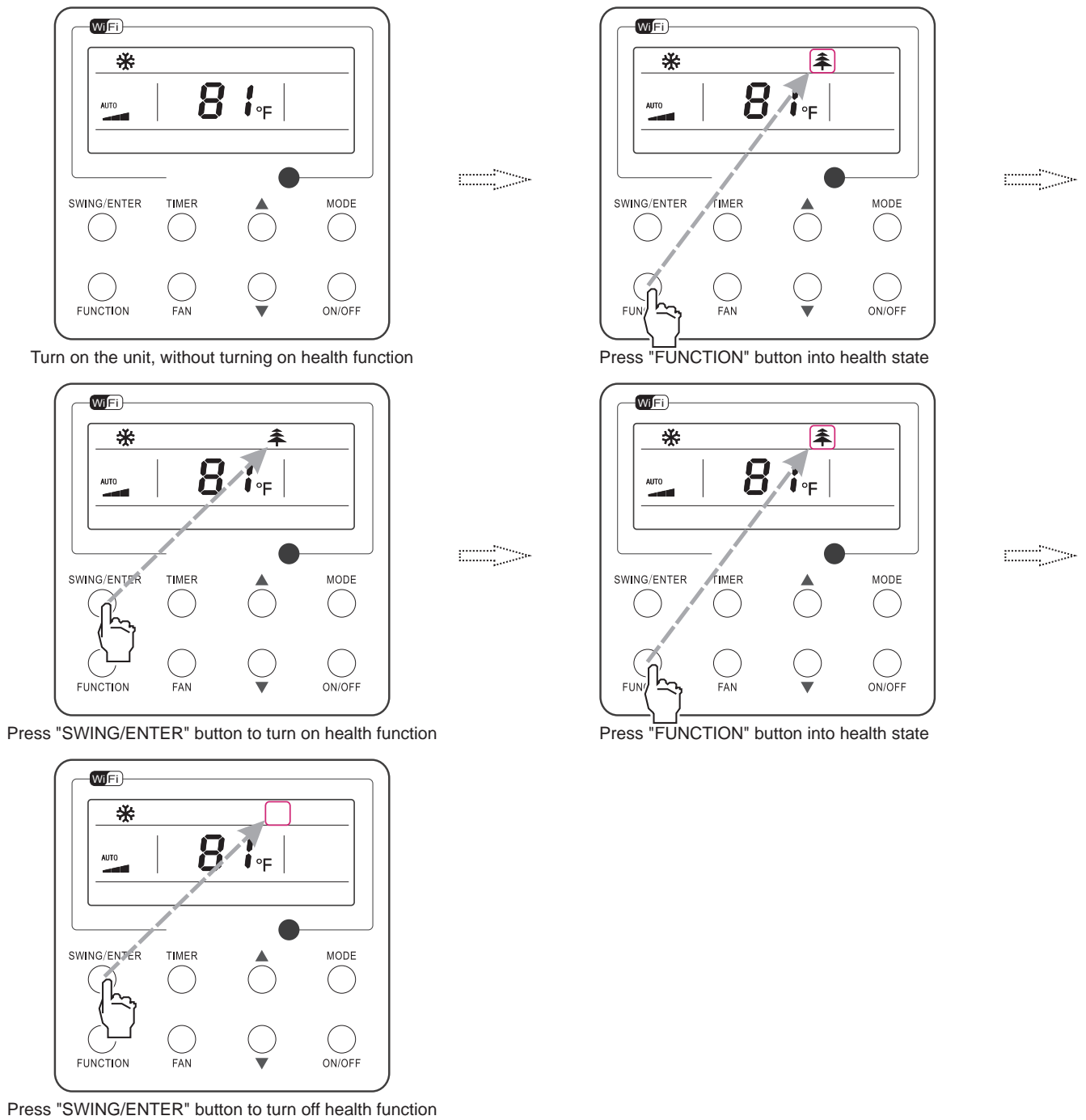

Fig. 17 Health Setting

3.16 Absent Setting

- Absent on: Press FUNCTION under on state of the unit till the unit enters the Absent setting interface. Press SWING/ENTER to confirm the setting.
- Absent off: When the Absent function is activated, press FUNCTION to enter the Absent setting interface. After that, press SWING/ENTER to cancel this function.

- NOTE:**
1. This function is only available in heating mode.
 2. When this function has been set, set temperature is displayed in 8°C(46°F). In this case, temperature setting and fan speed setting are shielded.
 3. This function will be cancelled when switching modes.
 4. This function and sleep function cannot be on simultaneously. If Absent function is set firstly and then sleep/quiet function is set, Absent function will be cancelled while sleep function will be valid, and vice versa.

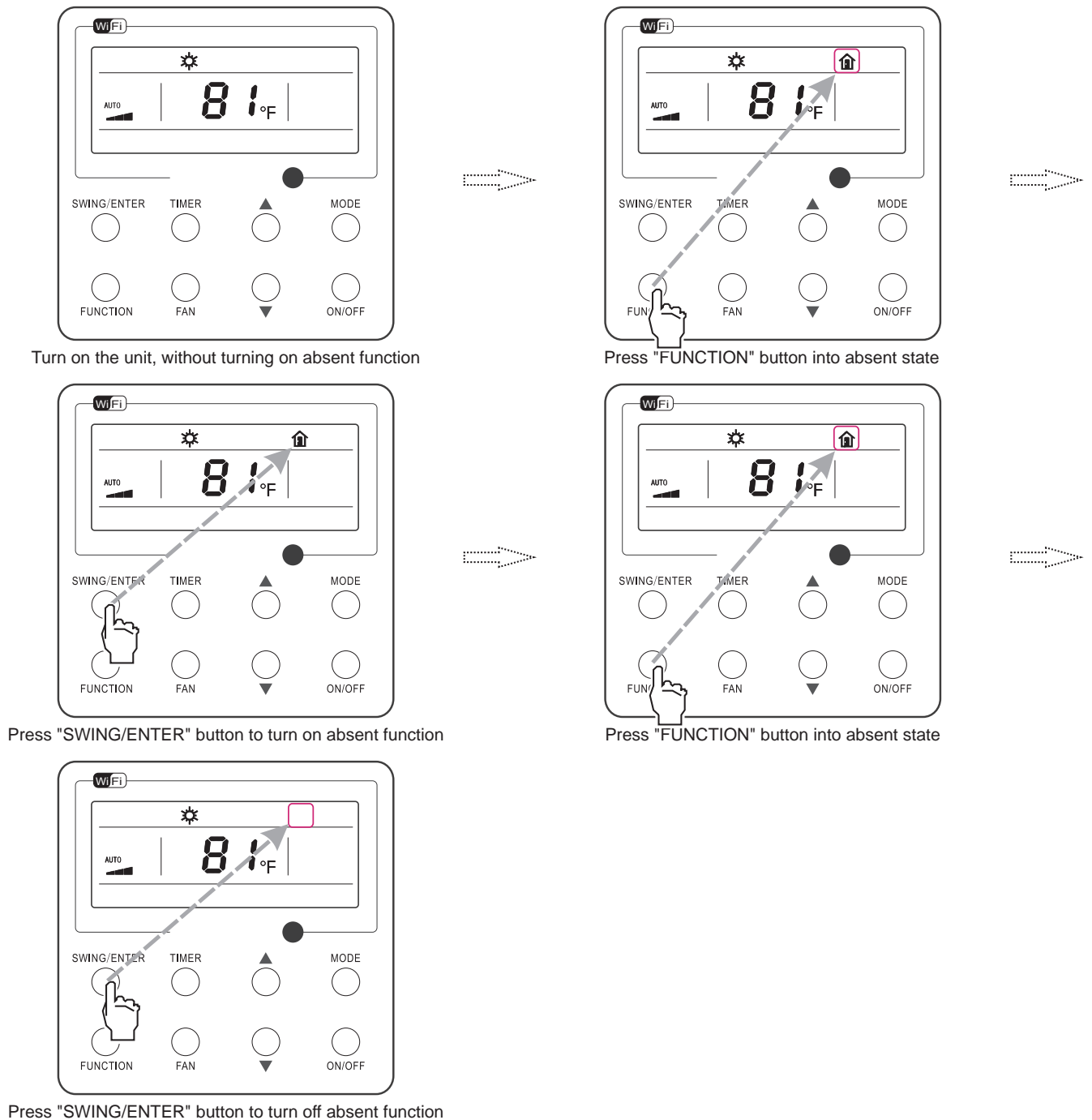
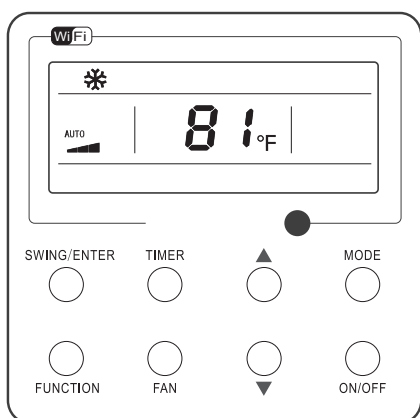

Fig. 18 Absent Setting

3.17 I-Demand Setting

- I-Demand on: Press FUNCTION under on state of the unit till the unit enters the I-Demand setting interface. Press SWING/ENTER to confirm the setting.
- I-Demand off: When the I-Demand function is activated, press FUNCTION to enter the I-Demand setting interface. After that, press SWING/ENTER to cancel this function.

- NOTE:**
1. This function is only available in cooling mode.
 2. When this function has been set, set temperature is displayed in SE. In this case, temperature setting and fan speed setting are shielded.
 3. This function will be cancelled when switching modes.
 4. This function and sleep function cannot be on simultaneously. If I-demand function is set firstly and then sleep/quiet function is set, I-demand function will be cancelled while sleep function will be valid, and vice versa.



Turn on the unit, without turning on I-demand function

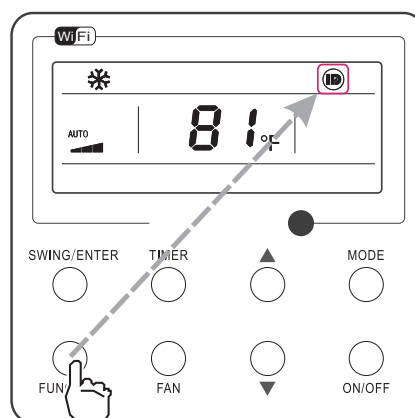

Press "FUNCTION" button into I-demand state

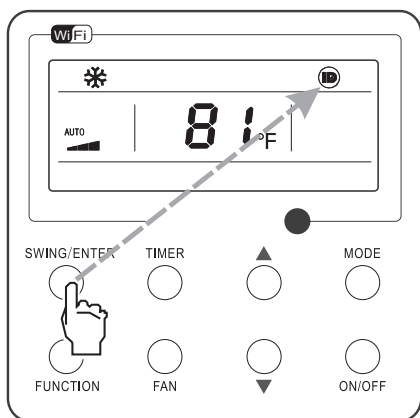

Press "SWING/ENTER" button to turn on I-demand function

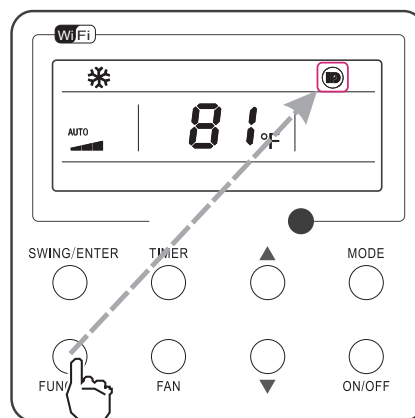

Press "FUNCTION" button into I-demand state

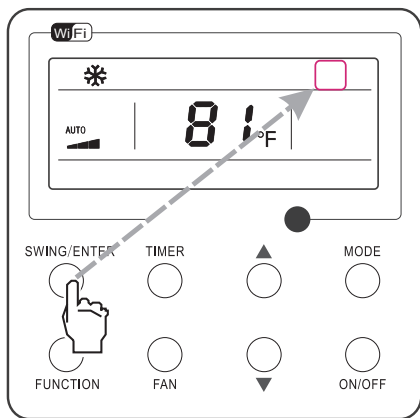

Press "SWING/ENTER" button to turn off I-demand function

Fig. 19 I-Demand Setting

3.18 WiFi Function Setting

"Gree+" APP can be used to control it. Please scan the QR code to download it.

APP can only set some common functions of WiFi wired controller: ON/OFF, mode, set temperature, FAN speed, etc.

When using the APP for the first time, please reset the WiFi function of wired controller (reset WiFi to exfactory setting): Under off status, press "FUNCTION" + "FAN" combination buttons on its wired controller for 5 seconds. Once "°C" is displayed, this indicates that reset was successful.

If there is a communication failure for WiFi, after resetting WiFi, the temperature display area of wired controller displays "JF" for 5 seconds, which indicates that the current reset is invalid.

Press FUNCTION under on state of the unit till the unit enters the WiFi setting interface, the temperature area will display the WiFi status. Press "▲" or "▼" button to turn on WiFi ("ON" is displayed) or turn off WiFi ("OFF" is displayed), and then press "SWING/ENTER" button to confirm it.

3.19 Dred Function Setting

When outdoor unit enters DRED mode: when it detects DRED signal, the whole unit executes DRED mode. When it enters DRED mode, the outdoor unit does timekeeping and feeds back the signal to indoor unit. Under power-on state, the set temperature area displays corresponding code, DRED1, DRED2, DRED3 correspond to "d1", "d2", "d3". The panel cannot be used to set the DRED mode.

When indoor unit enters DRED mode: under power-on state, use "Function" button on the panel to switch to "DRED" function. The set temperature area will display DRED state and flicker. Through "▲" and "▼" buttons can select DRED2 (set temperature area displays d2), DRED3 (set temperature area displays d3), or turn off DRED (set temperature area displays "--"); press "SWING/ENTER" button to confirm the selection, it will display the set state for 3 seconds. After entering the setting, if there is no button operation for 5 seconds, it will quit the interface without saving the setting.

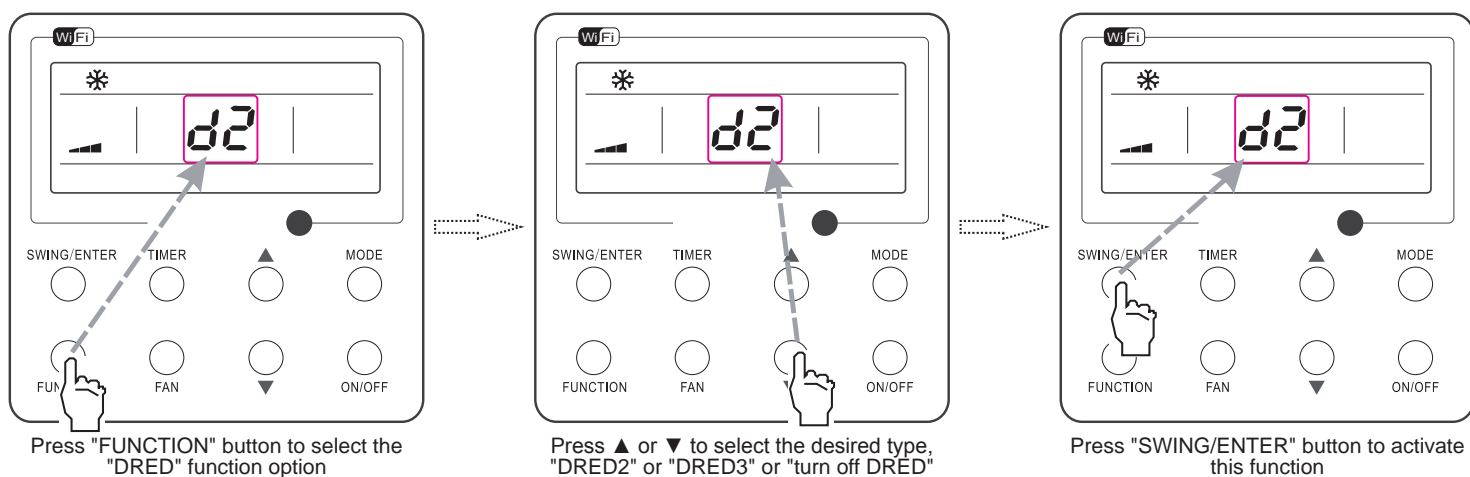

Dred Function Setting

NOTE:

- DRED mode startup method is set by indoor units.
- When outdoor unit enters DRED mode: it does not receive the DRED control of remote control, the whole unit will run the DRED mode, and the wired controller displays the state only.
- When indoor unit enters DRED mode:
 1. When the wired controller receives the DRED command sent from remote control, the set temperature area displays d2 or d3, and it will display for 3 seconds.
 2. Under power-off or air supply mode, the DRED mode is turned off.

3.20 Two-way Ventilation Function Setting

Under the "On/Off" state of the unit, press FUNCTION button on the panel to select "Two-way Ventilation" function option. Then press SWING/ENTER button to start up or turn off two-way ventilation function. When two-way ventilation function is started up,  will be shown on wired controller.

- NOTE:**
- Switch to power-off status, two-way ventilation function is turned off.
 - In power-off status, if the two-way ventilation function is activated, fan speed can be adjusted by fan speed button, and quiet or turbo function can be set.
 - This function is invalid when working with the model without two-way ventilation system.

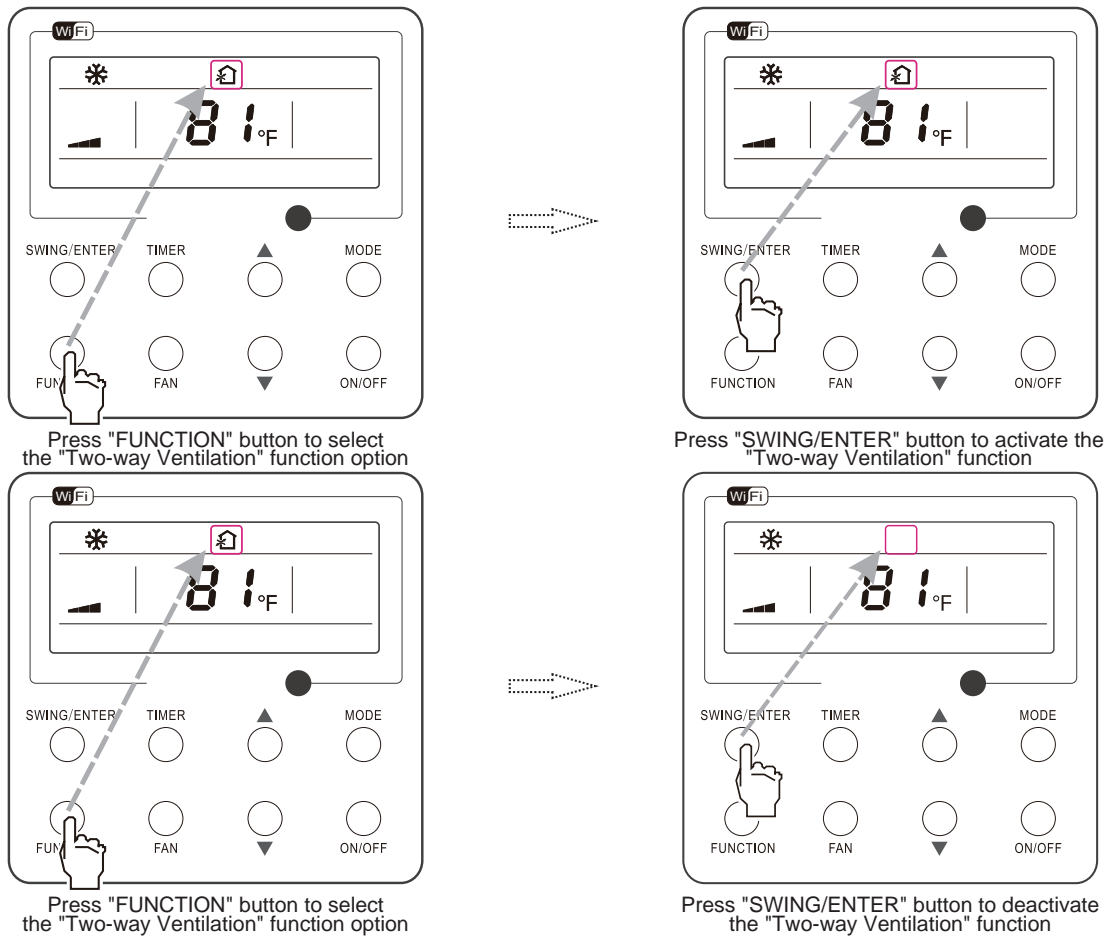

Two-way Ventilation Function Setting

3.21 Other Functions

1. Lock

Upon startup of the unit without malfunction or under the "OFF" state of the unit, press and at the same time for 5 seconds till the wired controller enters the Lock function. In this case, LCD displays . After that, repress these two buttons at the same time for 5 seconds to quit this function.

Under the Lock state, any other button press won't get any response.

2. Memory

Memory switchover: Under the "OFF" state of the unit, press Mode and at the same time for 5 seconds to switch memory states between memory on and memory off. When this function is activated, Memory will be displayed. If this function is not set, the unit will be under the "OFF" state after power failure and then power recovery.

Memory recovery: If this function has been set for the wired controller, the wired controller after power failure will resume its original running state upon power recovery. Memory contents: ON/OFF, Mode, set temperature, set fan speed and Lock function.

3. Selection of the Temperature Sensor

Under OFF state of the unit, press both "FUNCTION" and "TIMER" for five seconds to go the commissioning status. Under this status, adjust the display in the temperature display area to "00" through the button "MODE", and then adjust the option of the temperature sensor in the timer display area through the button ▲ or ▼.

- (1) Indoor ambient temperature is sensed at the return air inlet (01 in the timer display area).
- (2) Indoor ambient temperature is the sensed at the wired controller (02 in the timer display area).
- (3) Select the temperature sensor at the return air inlet under the cooling, dry and fan modes, while select the temperature sensor at the wired controller under the heating and auto modes. (03 in the timer display area).
- (4) Select the temperature sensor at the wired controller under the cooling, dry and fan modes, and select the temperature sensor at the return air inlet under the heating mode and auto modes (04 displayed in the timer display area).

After the setting, press "SWING/ENTER" to make a confirmation and quit this setting status.

Pressing the button "ON/OFF" also can quit this commissioning status but the set data won't be memorized.

Under the commissioning status, if there is no any operation in 20 seconds after the last button press, it will back to the previous

state without memorizing the current data.

NOTE:

After connected with indoor unit, if the type of ambient temperature sensor has not been manually set, the wired controller will select the ambient temperature sensor according to the model of connected IDU; if it connects to cassette type IDU, duct type IDU, floor ceiling type IDU, ceiling type IDU, it will adopt (3), otherwise it will adopt (1). If the type of ambient temperature sensor is set manually, the wired controller will subject to the manual setting, and will not set according to automatic IDU model selection.

4. Selection of the Fan Speed

Under OFF state of the unit, press both the buttons "FUNCTION" and "TIMER" for five seconds to go to the commissioning status, and then adjust the display in the temperature display area to 01 through the button "MODE" and adjust the setting of the fan speed, which comes to two options.

01: Three low fan speeds; 02: Three high fan speeds

After the setting, press "SWING/ENTER" to make a confirmation and quit this setting status.

Pressing the button "ON/OFF" also can quit this commissioning status but the set data won't be memorized.

Under the commissioning status, if there is no any operation in 20 seconds after the last button press, it will back to the previous state without memorizing the current data.

5. Inquiry of Ambient Temperature

Under off or on status, press and hold "SWING/ENTER" button for 5 seconds to enter into ambient temperature inquiry interface, then timer area displays the ambient temperature type 01 or 02, and ambient temperature area displays the corresponding ambient temperature of corresponding type. In which, 01 refers to outdoor ambient temperature, 02 refers to indoor ambient temperature. Press "MODE" button can switch between type 01 and 02. Press buttons other than "MODE" or when the unit receives remote control signal, it will quit the inquiry status. If there is no any operation for 5 seconds, it will quit automatically.

6.2 Brief Description of Models and Functions

1. Basic function of system

(1) Cooling mode

(1) Under this mode, fan and swing operates at setting status. Temperature setting range is 16~30°C.

(2) During malfunction of outdoor unit or the unit is stopped because of protection, indoor unit keeps original operation status.

(2)Drying mode

(1) Under this mode, fan operates at low speed and swing operates at setting status. Temperature setting range is 16~30°C.

(2) During malfunction of outdoor unit or the unit is stopped because of protection, indoor unit keeps original operation status.

(3) Protection status is same as that under cooling mode.

(4) Sleep function is not available for drying mode.

(3)Heating mode

(1) Under this mode, Temperature setting range is 16~30°C.

(2) Working condition and process for heating mode:

When turn on the unit under heating mode, indoor unit enters into cold air prevention status. When the unit is stopped or at OFF status, and indoor unit has been started up just now, the unit enters into residual heat-blowing status.

(4)Working method for AUTO mode:

1. Working condition and process for AUTO mode:

a. Under AUTO mode, standard heating $T_{\text{preset}}=20^{\circ}\text{C}$ and standard cooling $T_{\text{preset}}=25^{\circ}\text{C}$. The unit will switch mode automatically according to ambient temperature.

2. Protection function

a. During cooling operation, protection function is same as that under cooling mode.

b. During heating operation, protection function is same as that under heating mode.

3. Display: Set temperature is the set value under each condition. Ambient temperature is $(T_{\text{amb.}} - T_{\text{compensation}})$ for heat pump unit and $T_{\text{amb.}}$ for cooling only unit.

4. If there's I feel function, $T_{\text{compensation}}$ is 0. Others are same as above.

(5)Fan mode

Under this mode, indoor fan operates at set fan speed. Compressor, outdoor fan, 4-way valve and electric heating tube stop operation. Indoor fan can select to operate at high, medium, low or auto fan speed. Temperature setting range is 16~30°C.

2. Other control

(1) Buzzer

Upon energization or available operating the unit or remote controller, the buzzer will give out a beep.

(2) Auto button

If press this auto button when turning off the unit, the complete unit will operate at auto mode. Indoor fan operates at auto fan

speed and swing function is turned on. Press this auto button at ON status to turn off the unit.

(3) Auto fan

Heating mode: During auto heating mode or normal heating mode, auto fan speed will adjust the fan speed automatically according to ambient temperature and set temperature.

(4) Sleep

After setting sleep function for a period of time, system will adjust set temperature automatically.

(5) Timer function:

General timer and clock timer functions are compatible by equipping remote controller with different functions.

(6) Memory function

memorize compensation temperature, off-peak energization value.

Memory content: mode, up&down swing, light, set temperature, set fan speed, general timer (clock timer can't be memorized).

After power recovery, the unit will be turned on automatically according to memory content.

(7) Health function(only for the model with this function)

During operation of indoor fan, set health function by remote controller. Turn off the unit will also turn off health function.

Turn on the unit by pressing auto button, and the health is defaulted ON.

(8)Off-peak energization function:

Adjust compressors minimum stop time. The original minimum stop time is 180s and then we change to:

The time interval between two start-ups of compressor can't be less than $180+T$ s ($0 \leq T \leq 15$). T is the variable of controller. That's to say the minimum stop time of compressor is 180s~195s. Read-in T into memory chip when refurbish the memory chip each time. After power recovery, compressor can only be started up after $180+T$ s at least.

(9) SE control mode

The unit operates at SE status.

(10) X-fan mode

When X-fan function is turned on, after turn off the unit, indoor fan will still operate at low speed for 2min and then the complete unit will be turned off. When x-fan function is turned off, after turn off the unit, the complete unit will be turned off directly.

(11) 8°C heating function

Under heating mode, you can set 8°C heating function by remote controller. The system will operate at 8°C set temperature.

(12) Turbo fan control function

Set turbo function under cooling or heating mode to enter into turbo fan speed. Press fan speed button to cancel turbo wind.

No turbo function under auto, dry or fan mode.

7. Notes for Installation and Maintenance

Safety Precautions: Important!

Please read the safety precautions carefully before installation and maintenance.

The following contents are very important for installation and maintenance.

WARNING: Installation Must be Performed in Accordance with the NEC/CEC by Authorized Personnel Only.

Please follow the instructions below.

- The installation or maintenance must accord with the instructions.
- Comply with all national electrical codes and local electrical codes.
- Pay attention to the warnings and cautions in this manual.
- All installation and maintenance shall be performed by distributor or qualified person.
- All electric work must be performed by a licensed technician according to local regulations and the instructions given in this manual.
- Be caution during installation and maintenance. Prohibit incorrect operation to prevent electric shock, casualty and other accidents.



WARNINGS

Electrical Safety Precautions:

1. Cut off the power supply of air conditioner before checking and maintenance.
2. The air condition must apply specialized circuit and prohibit share the same circuit with other appliances.
3. The air conditioner should be installed in suitable location and ensure the power plug is touchable.
4. Make sure each wiring terminal is connected firmly during installation and maintenance.
5. Have the unit adequately grounded. The grounding wire can't be used for other purposes.
6. Must apply protective accessories such as protective boards, cable-cross loop and wire clip.
7. The live wire, neutral wire and grounding wire of power supply must be corresponding to the live wire, neutral wire and grounding wire of the air conditioner.
8. The power supply cord and power connection wires can't be pressed by hard objects.
9. If power supply cord or connection wire is broken, it must be replaced by a qualified person.
10. If the power supply cord or connection wire is not long enough, please get the specialized power supply cord or connection wire from the manufacture or distributor. Prohibit prolong the wire by yourself.

11. For the air conditioner without plug, an air switch must be installed in the circuit. The air switch should be all-pole parting and the contact parting distance should be more than 3mm.

12. Make sure all wires and pipes are connected properly and the valves are opened before energizing.

13. Check if there is electric leakage on the unit body. If yes, please eliminate the electric leakage.

14. Replace the fuse with a new one of the same specification if it is burnt down; dont replace it with a cooper wire or conducting wire.

15. If the unit is to be installed in a humid place, the circuit breaker must be installed.

Installation Safety Precautions:

1. Select the installation location according to the requirement of this manual.(See the requirements in installation part)
2. Handle unit transportation with care; the unit should not be carried by only one person if it is more than 20kg.
3. When installing the indoor unit and outdoor unit, a sufficient fixing bolt must be installed; make sure the installation support is firm.
4. Ware safety belt if the height of working is above 2m.
5. Use equipped components or appointed components during installation.
6. Make sure no foreign objects are left in the unit after finishing installation.

Refrigerant Safety Precautions:

1. When refrigerant leaks or requires discharge during installation, maintenance, or disassembly, it should be handled by certified professionals or otherwise in compliance with local laws and regulations.
- 2.Avoid contact between refrigerant and fire as it generates poisonous gas; Prohibit prolong the connection pipe by welding.
3. Apply specified refrigerant only. Never have it mixed with any other refrigerant. Never have air remain in the refrigerant line as it may lead to rupture or other hazards.
4. Make sure no refrigerant gas is leaking out when installation is completed.
5. If there is refrigerant leakage, please take sufficient measure to minimize the density of refrigerant.
6. Never touch the refrigerant piping or compressor without wearing glove to avoid scald or frostbite.

Improper installation may lead to fire hazard, explosion, electric shock or injury.

Safety Precautions for Installing and Relocating the Unit:

To ensure safety, please be mindful of the following precautions.

WARNINGS

1. When installing or relocating the unit, be sure to keep the refrigerant circuit free from air or substances other than the specified refrigerant.

Any presence of air or other foreign substance in the refrigerant circuit will cause system pressure rise or compressor rupture, resulting in injury.

2. When installing or moving this unit, do not charge the refrigerant which is not comply with that on the nameplate or unqualified refrigerant.

Otherwise, it may cause abnormal operation, wrong action, mechanical malfunction or even series safety accident.

3. When refrigerant needs to be recovered during relocating or repairing the unit, be sure that the unit is running in cooling mode. Then, fully close the valve at high pressure side (liquid valve). About 30-40 seconds later, fully close the valve at low pressure side (gas valve), immediately stop the unit and disconnect power. Please note that the time for refrigerant recovery should not exceed 1 minute.

If refrigerant recovery takes too much time, air may be sucked in and cause pressure rise or compressor rupture, resulting in injury.

4. During refrigerant recovery, make sure that liquid valve and gas valve are fully closed and power is disconnected before detaching the connection pipe.

If compressor starts running when stop valve is open and

connection pipe is not yet connected, air will be sucked in and cause pressure rise or compressor rupture, resulting in injury.

5. When installing the unit, make sure that connection pipe is securely connected before the compressor starts running.

If compressor starts running when stop valve is open and connection pipe is not yet connected, air will be sucked in and cause pressure rise or compressor rupture, resulting in injury.

6. Prohibit installing the unit at the place where there may be leaked corrosive gas or flammable gas.

If there leaked gas around the unit, it may cause explosion and other accidents.

7. Do not use extension cords for electrical connections. If the electric wire is not long enough, please contact a local service center authorized and ask for a proper electric wire.

Poor connections may lead to electric shock or fire.

8. Use the specified types of wires for electrical connections between the indoor and outdoor units. Firmly clamp the wires so that their terminals receive no external stresses.

Electric wires with insufficient capacity, wrong wire connections and insecure wire terminals may cause electric shock or fire.



R32 refrigerant warning

- To realize the function of the air conditioner unit, a special refrigerant circulates in the system. The used refrigerant is the fluoride R32, which is specially cleaned. The refrigerant is flammable and odorless. Furthermore, it can lead to explosion under certain conditions. But the flammability of the refrigerant is very low. It can be ignited only by fire.
- Compared to common refrigerants, R32 is a nonpolluting refrigerant with no harm to the ozone layer. The influence upon the greenhouse effect is also lower. R32 has got very good thermodynamic features which lead to a really high energy efficiency. The units therefore need a less filling.
- This product uses R32 difluoromethane refrigerant, which is a mildly flammable gas class A2L according to ISO 817 or ANSI/ASHRAE 34.
- "ANSI/ASHRAE 15 (USA) and CSA 852 (Canada)" stipulate that it must be handled by a refrigeration mechanic with an appropriate refrigerant handling licence.
- The appliance shall be stored in a room without continuously operating ignition sources. (for example: open flames, an operating gas appliance or an operating electric heater.)
- The appliance shall be stored in a well-ventilated area where the room size corresponds to the room area as specified for operation.
- The appliance shall be stored so as to prevent mechanical damage from occurring.
- Ducts connected to an appliance shall not contain an ignition source.
- Keep any required ventilation openings clear of obstruction.
- Do not pierce or burn.
- Be aware that refrigerants may not contain an odour.
- Do not use means to accelerate the defrosting process or to clean, other than those recommended by the manufacturer.
- Servicing shall be performed only as recommended by the manufacturer.
- Should repair be necessary, contact your nearest authorized Service Centre. Any repairs carried out by unqualified personnel may be dangerous.
- Compliance with national gas regulations shall be observed. Read specialist's manual.



- That pipe-work including piping material, pipe routing, and installation shall include protection from physical damage in operation and service, and be in compliance with national and local codes and standards, such as ASHRAE 15, ASHRAE 15.2, IAPMO Uniform Mechanical Code, ICC

International Mechanical Code, or CSA B52. All field joints shall be accessible for inspection prior to being covered or enclosed.

Notices for using refrigerant sensor

- Only applicable to refrigerant sensor models.
- The refrigerant sensor can monitor whether R32 refrigerant leaks in real time. When the leakage of R32 refrigerant is detected, the sensor will trigger the alarm and emit a buzzer, and the indoor unit will display "EA" code. Meanwhile, the outdoor unit will stop running.
- In case of refrigerant leakage, please open the window immediately for ventilation to reduce the concentration of refrigerant in the room. Meanwhile, check the room to ensure that there is no fire source. After completing the above operations, please leave the room and go to the safe place, and then contact the after-sales service team for maintenance.
- When the refrigerant sensor reaches its service life or is damaged, the indoor unit will display "FE" code. Please contact the after-sales service team to replace the refrigerant sensor.
- Avoid oil and water splashing into the refrigerant sensor, otherwise it may cause damage to the refrigerant sensor. Avoid using it in the environment with electromagnetic interference, chemical substances (such as chemical plants, etc.), flammable gas, combustible and explosive gas and smog, etc.
- Avoid using items containing ethanol (such as perfume, etc.) and smog-producing items (such as cigarettes, etc.) near the refrigerant sensor, otherwise it will lead to abnormal conditions such as false alarms of the refrigerant sensor. If such phenomenon occurs, please contact the after-sales service team for maintenance.

Safety Operation of Flammable Refrigerant

Aptitude requirement for maintenance man (repairs should be done only by specialists).

- Any person who is involved with working on or breaking into a refrigerant circuit should hold a current valid certificate from an industry-accredited assessment authority, which authorises their competence to handle refrigerants safely in accordance with an industry recognised assessment specification.
- Servicing shall only be performed as recommended by the equipment manufacturer. Maintenance and repair requiring the assistance of other skilled personnel shall be carried out under the supervision of the person competent in the use of flammable refrigerants

Safety preparation work

This product uses mildly flammable R32 refrigerant. Certain levels of refrigerant require minimum room sizes. Please ensure that these minimum room sizes are adhered to for standard installations. (Note: Please refer to the nameplate for the charging quantity of R32).

Appliance shall be installed, operated and stored in a room with a floor area larger than Xm^2 . (Please refer to table "a")

table a - Minimum room area (m²)

Charge amount (kg)	Height of ventilation opening(m)				
	0.6	1.8	2.2	2.5	3
Minimum room area (m ²)					
1.836	/	/	/	/	/
1.85	29.39	6.72	5.50	4.84	4.04
1.9	31.01	6.90	5.65	4.97	4.14
1.95	32.66	7.09	5.80	5.10	4.25
2	34.35	7.27	5.95	5.23	4.36
2.05	36.09	7.45	6.10	5.36	4.47
2.1	37.87	7.63	6.24	5.50	4.58
2.15	39.70	7.81	6.39	5.63	4.69
2.2	41.57	7.99	6.54	5.76	4.80
2.3	45.43	8.36	6.84	6.02	5.02
2.4	49.47	8.72	7.14	6.28	5.23
2.5	53.68	9.08	7.43	6.54	5.45
2.6	58.05	9.45	7.73	6.80	5.67
2.7	62.61	9.81	8.03	7.06	5.89
2.8	67.33	10.17	8.32	7.33	6.11
2.9	72.22	10.54	8.62	7.59	6.32
3	77.29	10.90	8.92	7.85	6.54
3.1	82.53	11.26	9.21	8.11	6.76
3.2	87.94	11.62	9.51	8.37	6.98
3.3	93.52	11.99	9.81	8.63	7.19
3.4	99.27	12.35	10.11	8.89	7.41
3.5	105.20	12.71	10.40	9.16	7.63

Information on servicing

Checks to the area

Prior to beginning work on systems containing FLAMMABLE REFRIGERANTS, Safety checks are necessary to ensure that the risk of ignition is minimised. For repair to the REFRIGERATING SYSTEM, the following precautions shall be completed prior to conducting work on the system.

Work procedure

Work shall be undertaken under a controlled procedure so as to minimise the risk of a flammable gas or vapour being present while the work is being performed.

General work area

All maintenance staff and others working in the local area shall be instructed on the nature of work being carried out. Work in confined spaces shall be avoided.

Checking for presence of refrigerant

The area shall be checked with an appropriate refrigerant detector prior to and during work, to ensure the technician is aware of potentially toxic or flammable atmospheres. Ensure that the leak detection equipment being used is suitable for use with all applicable refrigerants, i.e. non-sparking, adequately sealed or intrinsically safe.

Presence of fire extinguisher

If any hot work is to be conducted on the refrigerating equipment or any associated parts, appropriate fire extinguishing equipment shall be available to hand. Have a dry powder or CO₂ fire extinguisher adjacent to the charging area.

No ignition sources

No person carrying out work in relation to a REFRIGERATING SYSTEM which involves exposing any pipe work shall use any sources of ignition in such a manner that it may lead to the risk of fire or explosion. All possible ignition sources, including cigarette smoking, should be kept sufficiently far away from the site of installation, repairing, removing and disposal, during which refrigerant can possibly be released to the surrounding space. Prior to work taking place, the area around the equipment is to be surveyed to make sure that there are no flammable hazards or ignition risks. "No Smoking" signs shall be displayed.

Ventilated area

Ensure that the area is in the open or that it is adequately ventilated before breaking into the system or conducting any hot work. A degree of ventilation shall continue during the period that the work is carried out. The ventilation should safely disperse any released refrigerant and preferably expel it externally into the atmosphere.

Checks to the refrigerating equipment

Where electrical components are being changed, they shall be fit for the purpose and to the correct specification. At all times the manufacturer's maintenance and service guidelines shall be followed. If in doubt, consult the manufacturer's technical department for assistance.

The following checks shall be applied to installations using FLAMMABLE REFRIGERANTS:

- the actual REFRIGERANT CHARGE is in accordance with the room size within which the refrigerant containing parts are installed.
- the ventilation machinery and outlets are operating adequately and are not obstructed;
- if an indirect refrigerating circuit is being used, the secondary circuit shall be checked for the presence of refrigerant;
- marking to the equipment continues to be visible and legible. Markings and signs that are illegible shall be corrected.
- refrigerating pipe or components are installed in a position where they are unlikely to be exposed to any substance which may corrode refrigerant containing components, unless the components are constructed of materials which are inherently resistant to being corroded or are suitably protected against being so corroded.

Checks to electrical devices

Repair and maintenance to electrical components shall include initial safety checks and component inspection procedures. If a fault exists that could compromise safety, then no electrical supply shall be connected to the circuit until it is satisfactorily dealt with. If the fault cannot be corrected immediately but it is necessary to continue operation, an adequate temporary solution shall be used. This shall be reported to the owner of the equipment so all parties are advised.

Initial safety checks shall include:

- that capacitors are discharged: this shall be done in a safe manner to avoid possibility of sparking;
- that no live electrical components and wiring are exposed while charging, recovering or purging the system;
- that there is continuity of earth bonding.

Repairs to sealed components

Sealed electrical components shall be replaced.

Repair to intrinsically safe components

Intrinsically safe components must be replaced.

Cabling

Check that cabling will not be subject to wear, corrosion, excessive pressure, vibration, sharp edges or any other adverse environmental effects. The check shall also take into account the effects of aging or continual vibration from sources such as compressors or fans.

Detection of flammable refrigerants

Under no circumstances shall potential sources of ignition be used in the searching for or detection of refrigerant leaks. A halide torch (or any other detector using a naked flame) shall not be used.

The following leak detection methods are deemed acceptable for all refrigerant systems.

Electronic leak detectors may be used to detect refrigerant leaks but, in the case of FLAMMABLE REFRIGERANTS, the sensitivity may not be adequate, or may need re-calibration. (Detection equipment shall be calibrated in a refrigerant-free area.) Ensure that the detector is not a potential source of ignition and is suitable for the refrigerant used. Leak detection equipment shall be set at a percentage of the LFL of the refrigerant and shall be calibrated to the refrigerant employed, and the appropriate percentage of gas (25% maximum) is confirmed.

Leak detection fluids are also suitable for use with most refrigerants but the use of detergents containing chlorine shall be avoided as the chlorine may react with the refrigerant and corrode the copper pipe-work.

NOTE Examples of leak detection fluids are

- bubble method,
- fluorescent method agents

If a leak is suspected, all naked flames shall be removed/ extinguished.

If a leakage of refrigerant is found which requires brazing, all of the refrigerant shall be recovered from the system, or isolated (by means of shut off valves) in a part of the system remote from the leak. Removal of refrigerant shall be according to Clause "Removal and evacuation".

Removal and evacuation

When breaking into the refrigerant circuit to make repairs -or for any other purpose -conventional procedures shall be used. However, for flammable refrigerants it is important that best practice be followed, since flammability is a consideration. The following procedure shall be adhered to:

- Safely remove refrigerant following local and national regulations;
- evacuate;
- purge the circuit with inert gas (optional for A2L);
- evacuate (optional for A2L);
- continuously flush or purge with inert gas when using flame to open circuit; and
- open the circuit.

The refrigerant charge shall be recovered into the correct recovery cylinders if venting is not allowed by local and national codes. For appliances containing flammable refrigerants, the system shall be purged with oxygen-free nitrogen to render the appliance safe for flammable refrigerants. This process might need to be repeated several times. Compressed air or oxygen shall not be used for purging refrigerant systems.

For appliances containing flammable refrigerants, refrigerant purging shall be achieved by breaking the vacuum in the system with oxygen-free nitrogen and continuing to fill until the working pressure is achieved, then venting to atmosphere, and finally pulling down to a vacuum (optional for A2L). This process shall be repeated until no refrigerant is within the system (optional for A2L). When the final oxygen-free nitrogen charge is used, the system shall be vented down to atmospheric pressure to enable work to take place.

The outlet for the vacuum pump shall not be close to any potential ignition sources, and ventilation shall be available

Charging procedures

In addition to conventional charging procedures, the following requirements shall be followed.

- Ensure that contamination of different refrigerants does not occur when using charging equipment.
- Hoses or lines shall be as short as possible to minimise the amount of refrigerant contained in them.
- Cylinders shall be kept in an appropriate position according to the instructions.
- Ensure that the REFRIGERATING SYSTEM is earthed prior to charging the system with refrigerant.
- Label the system when charging is complete (if not already).
- Extreme care shall be taken not to overfill the REFRIGERATING SYSTEM.

Prior to recharging the system, it shall be pressure-tested with the appropriate purging gas. The system shall be leak-tested on completion of charging but prior to commissioning. A follow up leak test shall be carried out prior to leaving the site.

Decommissioning

Before carrying out this procedure, it is essential that the technician is completely familiar with the equipment and all its detail. It is recommended good practice that all refrigerants are recovered safely. Prior to the task being carried out, an oil and refrigerant sample shall be taken in case analysis is required prior to re-use of recovered refrigerant. It is essential that electrical power is available before the task is commenced.

- a) Become familiar with the equipment and its operation.
- b) Isolate system electrically
- c) Before attempting the procedure, ensure that:
 - mechanical handling equipment is available, if required, for handling refrigerant cylinders;
 - all personal protective equipment is available and being used correctly;
 - the recovery process is supervised at all times by a competent person;
 - recovery equipment and cylinders conform to the appropriate standards.
- d) Pump down refrigerant system, if possible
- e) If a vacuum is not possible, make a manifold so that refrigerant can be removed from various parts of the system.
- f) Make sure that cylinder is situated on the scales before recovery takes place
- g) Start the recovery machine and operate in accordance with instructions
- h) Do not overfill cylinders (no more than 80 % volume liquid charge).
- i) Do not exceed the maximum working pressure of the cylinder even temporarily.
- j) When the cylinders have been filled correctly and the process completed, make sure that the cylinders and the equipment are removed from site promptly and all isolation valves on the equipment are closed off.
- k) Recovered refrigerant shall not be charged into another REFRIGERATING SYSTEM unless it has been cleaned and checked.

Labelling

Equipment shall be labelled stating that it has been decommissioned and emptied of refrigerant. The label shall be dated and signed. For appliances containing FLAMMABLE REFRIGERANTS, ensure that there are labels on the equipment stating the equipment contains FLAMMABLE REFRIGERANT.

Recovery

When removing refrigerant from a system, either for servicing or decommissioning, it is recommended good practice that all refrigerants are removed safely.

When transferring refrigerant into cylinders, ensure that only appropriate refrigerant recovery cylinders are employed. Ensure that the correct number of cylinders for holding the total system charge is available. All cylinders to be used are designated for the recovered refrigerant and labelled for that refrigerant (i.e. special cylinders for the recovery of refrigerant). Cylinders shall be complete with pressure-relief valve and associated shut-off valves in good working order. Empty recovery cylinders are evacuated and, if possible cooled before recovery occurs.

The recovery equipment shall be in good working order with a set of instructions concerning the equipment that is at hand and shall be suitable for the recovery of the flammable refrigerant. If in doubt, the manufacturer should be consulted. In addition, a set of calibrated weighing scales shall be available and in good working order. Hoses shall be complete with leak-free disconnect couplings and in good condition.

The recovered refrigerant shall be processed according to local legislation in the correct recovery cylinder, and the relevant waste transfer note arranged. Do not mix refrigerants in recovery units and especially not in cylinders.

If compressors or compressor oils are to be removed, ensure that they have been evacuated to an acceptable level to make certain that flammable refrigerant does not remain within the lubricant. The compressor body shall not be heated by an open flame or other ignition sources to accelerate this process. When oil is drained from a system, it shall be carried out safely.

Main Tools for Installation and Maintenance



Level meter



Measuring tape



Screw driver



Impact drill



Drill head



Electric drill



Electroprobe



Universal meter



Torque wrench



Open-end wrench



Inner hexagon spanner



Electronic leakage detector



Vacuum pump



Pressure meter



Pipe pliers



Pipe pliers



Pipe cutter



Pipe expander



Pipe bender



Soldering appliance



Refrigerant container



Electronic scale

8. Installation Manual

Installation procedures

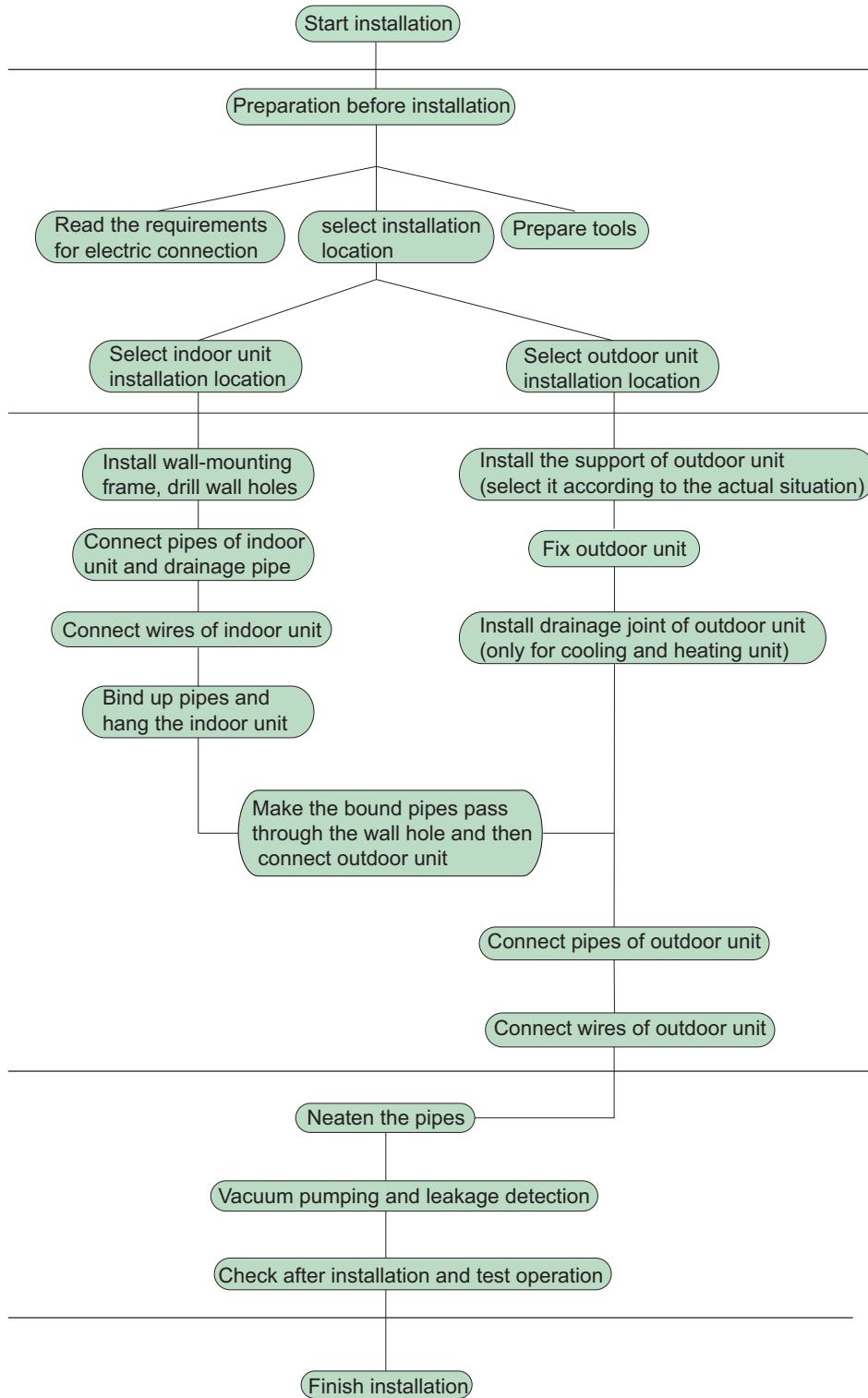









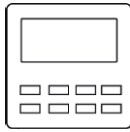

Note: this flow is only for reference; please find the more detailed installation steps in this section.

8.1 Preparations for Installation

NOTICE!

Product graphics are only for reference. Please refer to actual products. Unspecified measure unit is mm(in.)

Please use the supplied standard fittings listed below as instructed.

No.	Name	Appearance	Q'ty	Usage
1	Wired Controller		1	To control the indoor unit
2	Drain Hose Assembly		1	To connect with the hard PVC drain pipe
3	Special Nut		1	To be used for connecting the refrigerant pipe
4	M10X8 Nut with Washer		4	To be used together with the hanger bolt for installing the unit
5	M10 Nut (M10X8.4 Nut)		4	To be used together with the hanger bolt for installing the unit
6	M10 Washer (Spring Washer M10X2.6)		4	To be used together with the hanger bolt for installing the unit
7	Insulation		1	To insulate the gas pipe
8	Insulation		1	To insulate the liquid pipe
9	Sponge		2	To insulate the drain pipe
10	Fastener		8	To fasten the sponge

8.2 Location for Installation

- (1) The appliance shall not be installed in the laundry.
- (2) The top holder must be strong enough to support unit's weight.
- (3) Drain pipe can drain water out easily.
- (4) There is no obstacle at inlet or outlet. Please ensure good air circulation.
- (5) In order to make sure the space for maintenance, please install the indoor unit according to the dimension described below.
- (6) Keep the unit away from heating source, inflammable gas or smoke.
- (7) This is a concealed ceiling type unit.
- (8) Indoor unit, outdoor unit, power cord and electric wire should stay at least 1m(39-3/8 in.) from the TV set and radio. Otherwise, these electrical appliances may have image interference and noise. (Even if the distance is 1m(39-3/8 in.), when there is strong electric wave, noise may still occur.)

NOTICE:

- (1) Installation of the unit must be in accordance with National Electric Codes and local regulations.
- (2) Improper installation will affect unit's performance, so do not install the unit by yourself. Please contact local dealer to arrange professional technicians for the installation.
- (3) Do not connect power until all installation work is finished.

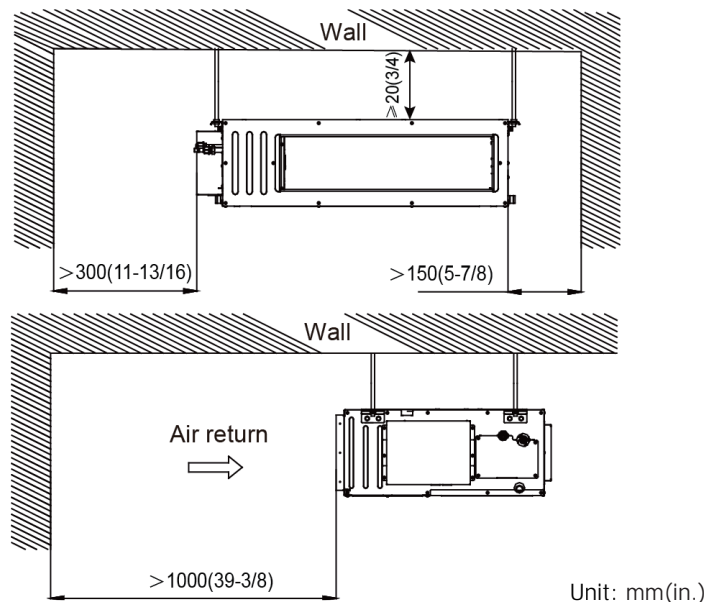

8.3 Wiring Requirements

(1) Power Cord Size and Air Switch Capacity

Model	Power Supply	Fuse Capacity(A)	Min. Power Supply Cord
DUC09HP230V1R32AH	208/230V-1ph-60Hz	5	4xAWG14
DUC12HP230V1R32AH		5	
DUC18HP230V1R32AH		5	
GFH(21)DB-D6DNA1A/I		5	
DUC24HP230V1R32AH		5	

NOTICE:

- (1) Use copper wire only as unit's power cord. Operating temperature should be within it value.
- (2) If the power cord is more than 15m (49-1/4 ft.) long, please increase properly the sectional area of power cord to avoid overload, which may cause accident.
- (3) Above selection requirements: Power cord size is based on BV single-core wire (2~4pc) at 40°C(104°F) Ambient temperature when laying across plastic pipe. Air switch is D type and used at 40°C(104°F). If actual installation condition varies, please lower the capacity appropriately according to the specifications of power cord and air switch provided by manufacturer.
- (4) Install cut-off device near the unit. The minimum distance between each stage of cut-off device should be 3mm(1/8 in.) (The same for both indoor unit and outdoor unit).

9. Installation Instructions

NOTICE!

These duct type indoor units are limited to be installed for one room.

9.1 Suspend the indoor unit

(1) Drill bolt holes and install bolts

1. Stick the reference cardboard on the installation position; drill 4 holes according to the hole site on the cardboard as shown in fig 1. ; diameter of drilling hole is according to the diameter of expansion bolt and the depth is 60-70mm(2-3/8~2-3/4 in.), as shown in fig 2.

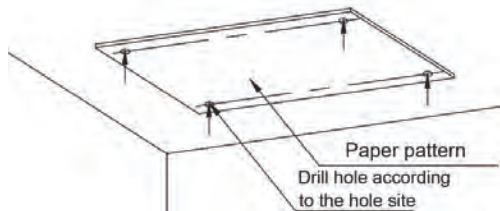

Fig 1

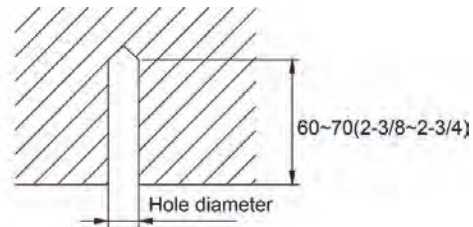

Fig 2

2. Insert the M10 expansion bolt into the hole and then knock the nail into the bolt, as shown in fig 3, and then remove the paper pattern.

NOTICE!

The length of bolt depends on the installation height of the unit, bolts are field supplied.

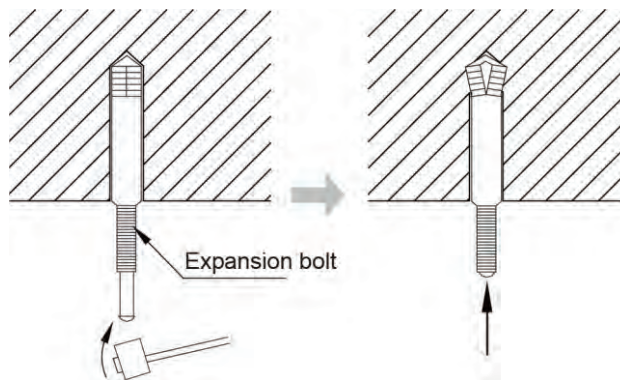

Fig 3

(2) Install the indoor unit temporarily

Assemble suspension bolt on the expansion bolt, attach the hanger bracket to the suspension bolt. Be sure to fix it securely by using a nut and washer from upper and lower sides of the hanger bracket. The washer fixing plate will prevent the washer from falling.

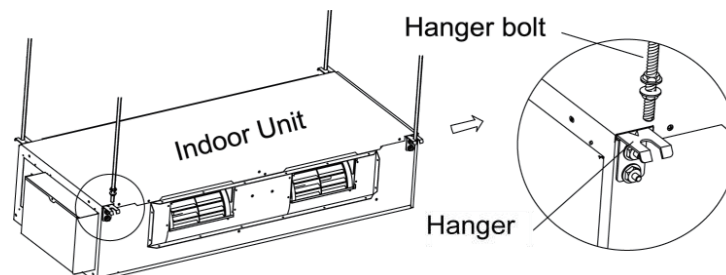

Fig 4

NOTICE!

1. Before operation, please prepare all pipelines (connection pipe, drainage hose) and wires (connection wire for wired controller, connection wire for indoor unit).
2. When drilling holes on ceiling (air return outlet or air outlet), you can need to reinforce the ceiling to prevent vibration. For details, please consult user or builder.
3. If the strength of the ceiling is not good, please install a beam bracket, and then put the unit on the beam bracket.

(3) Adjust the unit to the right position.

(4) Check the level of the unit

After the indoor unit is installed, remember to check the horizontal status of the whole unit. It should be horizontal from front to back and slant 1% from left to right, following the drainage direction.

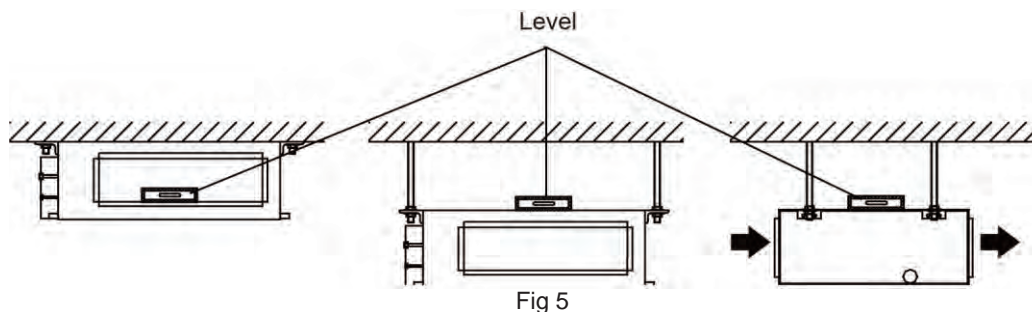

(5) Remove the washer locating plate and then tighten the nut on it.

9.2 Refrigerant Pipe Connection

1. Aim the flaring port of copper pipe at the center of screwed joint and then tighten the flaring nut with hand as shown in fig 6.
2. Tighten the flaring nut with torque wrench.

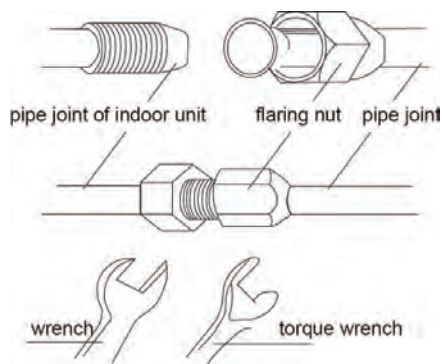

Refer to the following table for wrench moment of force:

Piping size	Tightening torque(ft-lb)
1/4"	11-14
3/8"	22-29
1/2"	33-40
5/8"	44-47
3/4"	51-55

3. Use pipe bend when bending the pipe and the bending angle should not be too small.
4. Wrap the connection pipe and joint with sponge and then tie them firmly with tape.

9.3 Drainage Pipe Installation and Drainage System Testing

(1) Notice for Installation of Drain Pipe

1. The drainage pipe should be short and the gradient downwards should be at least 1%~2% in order to drain condensation water smoothly.
2. The diameter of drainage hose should be bigger or equal to the diameter of drainage pipe joint.
3. Install drainage pipe according to the following fig and arrange insulation to the drainage pipe (Fig 4.3.1). Improper installation may lead to water leakage and damp the furniture and other things in the room.
4. You can buy normal hard PVC pipe used as the drainage pipe. During connection, insert the end of PVC pipe into the drainage hole and then tighten it with drainage hole and wire binder. Can't connect the drainage hole and drainage hole with glue.
5. When the drainage pipelines are used for several units, the position of pipeline should be about 100mm(4in.) lower than the drainage port of each unit. In this case, thicker pipes should be applied.

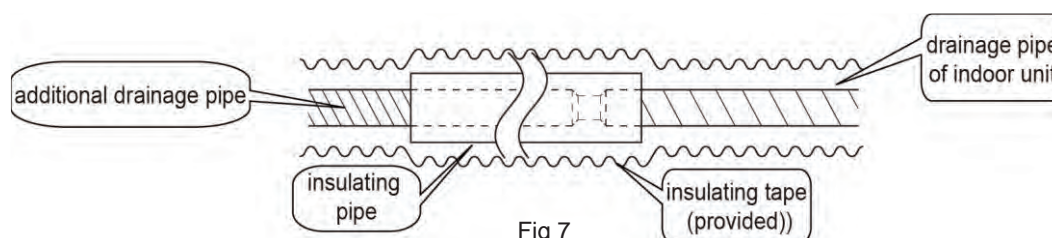

(2) Drainage pipe installation

1. Insert the drain hose into the drain hole and tighten it with tapes, as shown in Fig 8.
2. Tighten the pipe clamp, with the distance between screw nut and hose smaller than 4mm(1/8in.).

- ① metal clamp(accessory)
- ② drain hose(accessory)

3. Use sealing plate to make the pipe clamp and hose insulated, as shown in Fig.9.

- ① metal clamp(accessory)
- ② thermal sponge(accessory)

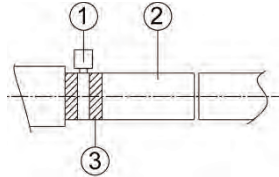

Fig 8

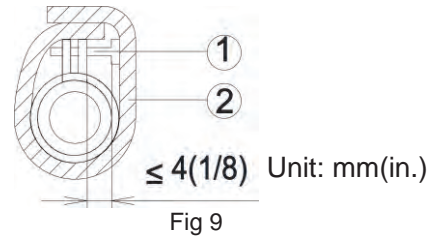

Fig 9

4. Wrap the connection pipe and joint with sponge and then tie them firmly with tape.

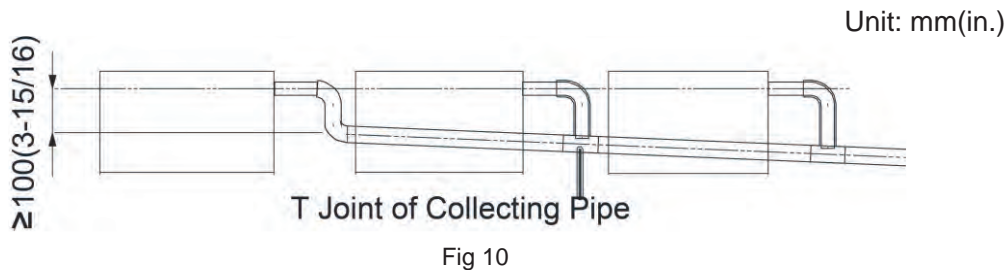
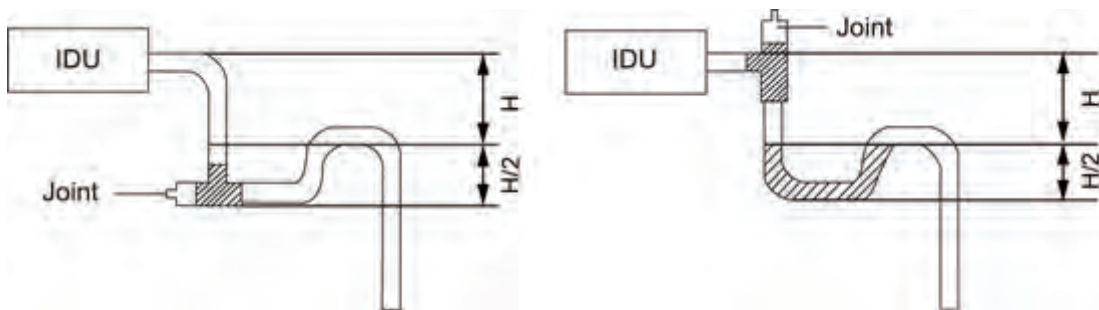

Fig 10

5. Install the trap as shown in following Fig 11
6. Install one trap for each unit.
7. Convenience for cleaning trap in the future should be considered when installing it.



8. The horizontal pipe can be connected to vertical pipe in the same level; please select the connection way as shown in following fig.

NO1: Connection of drainage pipe joints (Fig 12)

NO2: Connection of downspout elbow (Fig 13)

NO3: Inserting pipe connection (Fig 14)

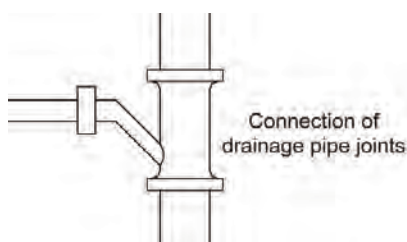

Fig 12

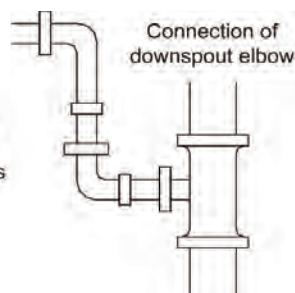
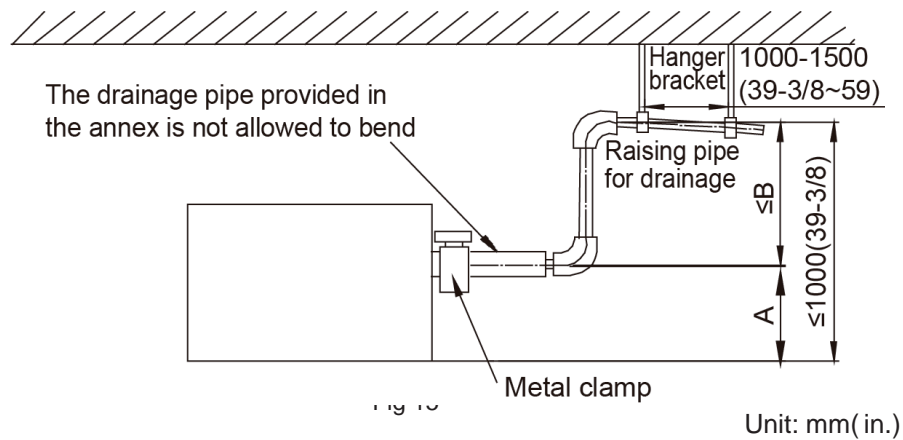

Fig 13



Fig 14

9. The installation height of raising pipe for drainage should be lower than B. The gradient from raising pipe towards drainage direction should be at least 1%~2%. If the raising pipe is vertical with the unit, the raising height should be less than C.



Model	A	B	C
DUC09HP230V1R32AH	150(5-7/8)	850(33-1/2)	800(31-1/2)
DUC12HP230V1R32AH			
DUC18HP230V1R32AH			
GFH(21)DB-D6DNA1A/I			
DUC24HP230V1R32AH			

10. Drain pipes should have a downward slope of at least 1%~2%, in order to prevent pipes from sagging, install hanger bracket at intervals of 1000~1500mm(39-3/8~59 in.).

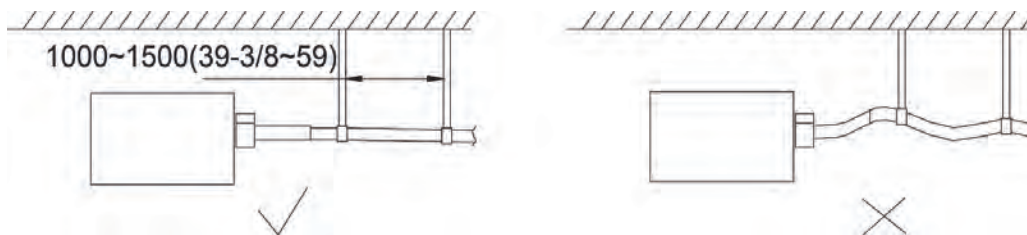

(3) Test of Drainage System

Models with water pump

1. Please test drainage system after electric work is finished.

Inject approximately 1L purified water to drain pan from air vent, ensure that not to splash the water over the electrical components (e.g. water pump. etc.).

(1) Spray 1L water on evaporator with sprayer.

(2) In case of commissioning finished, please energize the IDUs and switch to cooling or dry mode, meanwhile, the water pump operates, you can check the draining through the transparent part of drain socket.

(3) If communication wire is not connected, communication malfunction "E6" will occur after 3min of energizing. In this case, the water pump operates automatically. Check if the water pump drains normally through drainage port. The water pump will stop automatically after running for 1min.

2. During the test, please carefully check the drainage joint, make sure no any leakage occur.

3. It is strongly recommend to do the drain test before ceiling decoration.

Models without water pump

1. Inject some water to the water tray of indoor unit as following:

(1) Connect the drain hose to the other drain connection pipe of water tray and inject approximately 1L water. (Remove the drain hose after finishing testing and then put on the plug of water tray.)

(2) Spray 1L water on evaporator with sprayer.

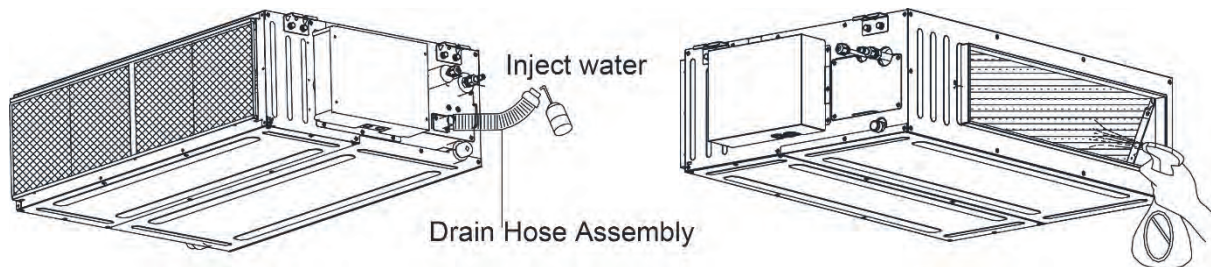

Fig 17

2. Check if the water drains smoothly from the drain pipe and check if there is water leakage on the connection pipe.
3. Arrange insulation of drain hose and pipe clamp after checking the drain system.

9.4 Installation of Air Duct

NOTICE!

- There should be insulating layer on air-out duct, air-return duct and fresh air duct to avoid heat loss and moisture. Adhere a nail on the air duct and then add thermal sponge with a layer of tin. Fasten it with a nail cover and then seal the junction with tin tapes. You can also use other materials that have good insulation quality.
- Each air-out duct and air-return duct should be fixed on a pre-made board with iron frame. The junction of air duct should be well-sealed in order to prevent air leakage.
- The design and construction of air duct should comply with national requirements.
- The edge of air-return duct is suggested to be more than 150mm(5-7/8 in.) away from the wall. Add a filter to the air-return opening.
- Please consider noise-damping and vibration damping for the design and construction of air duct. Besides, noise source must be away from people. For instance, do not have the air-return opening installed on top of the user (Offices, rest area, etc.).

(1)Shape and Size of Air Outlet and Air-return Opening

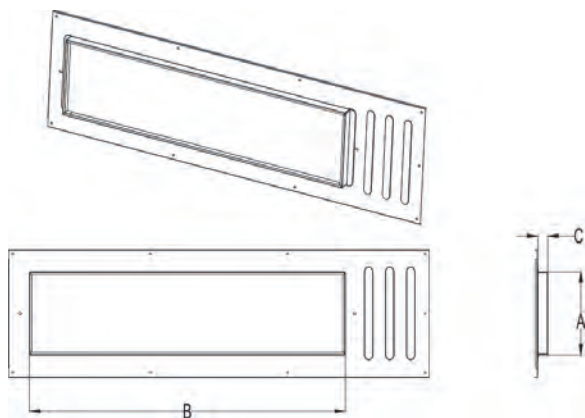

Fig 18

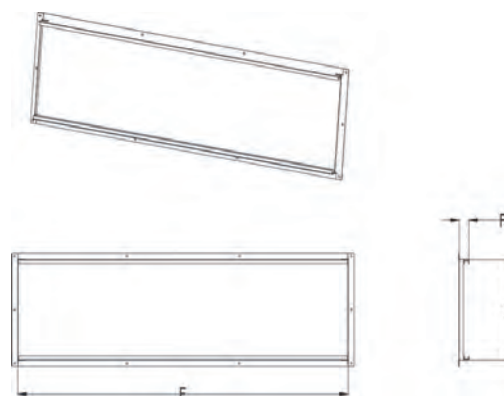

Fig 19

Model	Size of Air Outlet mm(inch)			Size of Air-return Opening mm(inch)		
	A	B	C	D	E	F
DUC09HP230V1R32AH	195	451	25	264	660	29
DUC12HP230V1R32AH	(7-5/8)	(17-3/4)	(1)	(10-3/8)	(26)	(1-1/8)
DUC18HP230V1R32AH	195	751	25	264	960	29
GFH(21)DB-D6DNA1A/I	(7-5/8)	(29-9/16)	(1)	(10-3/8)	(37-3/4)	(1-1/8)
DUC24HP230V1R32AH						

(2) Installation of Air-out Duct

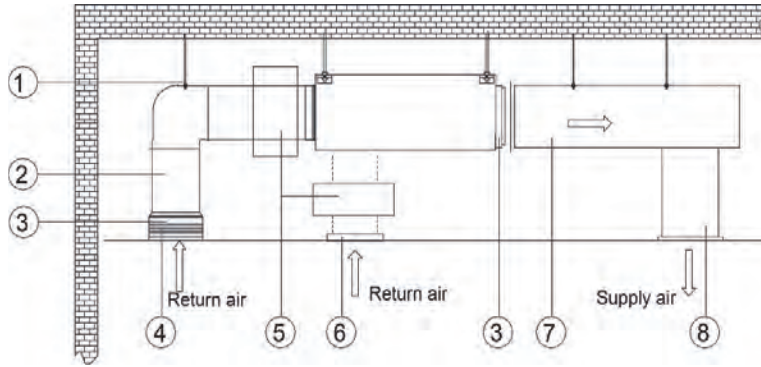

Fig 20

No.	Name	No.	Name
1	Hanger Rod	5	Static Pressure Box
2	Return Air Duct	6	Filter
3	Canvas Duct	7	Main Supply Air Duct
4	Return Air Inlet	8	Supply Air Outlet

(3) Installation of the Return Air Duct

(1) The default installation location of the rectangular flange is at the back and the return air cover plate is at the bottom, as shown in Fig 21.

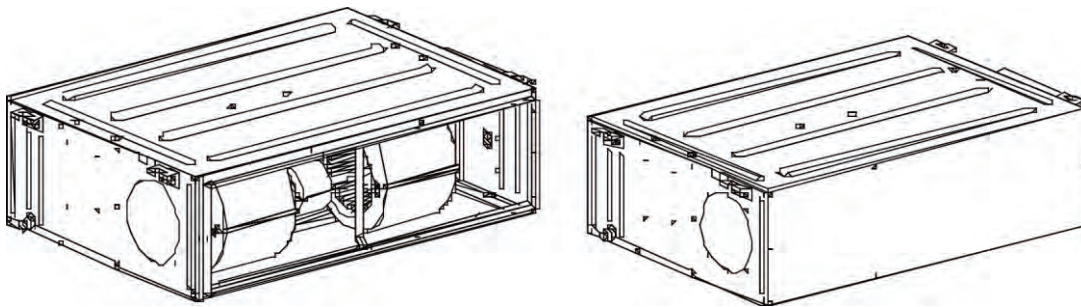

Fig 21

(2) If the bottom return air is desired, just change the place of the rectangular flange and the return air cover plate.

(3) Connect one end of the return air duct to the return air outlet of the unit by rivets and the other to the return air louver. For the sake of the convenience to freely adjust the height, a cutting of canvas duct will be helpful, which can be reinforced and folded by 8# iron wire.

(4) More noise is likely to be produced in the bottom return air mode than the rear return air mode, so it is suggestive to install a silencer and a static pressure box to minimize the noise.

(5) The installation method can be chosen with considering the conditions of the building and maintenance etc., as shown in Fig 22.

Installation of the return air duct

No.	Name	No.	Name
1	Return Air Inlet (with filter)	4	Indoor unit
2	Canvas Duct	5	Supply Air Duct
3	Return Air Duct	6	Grille

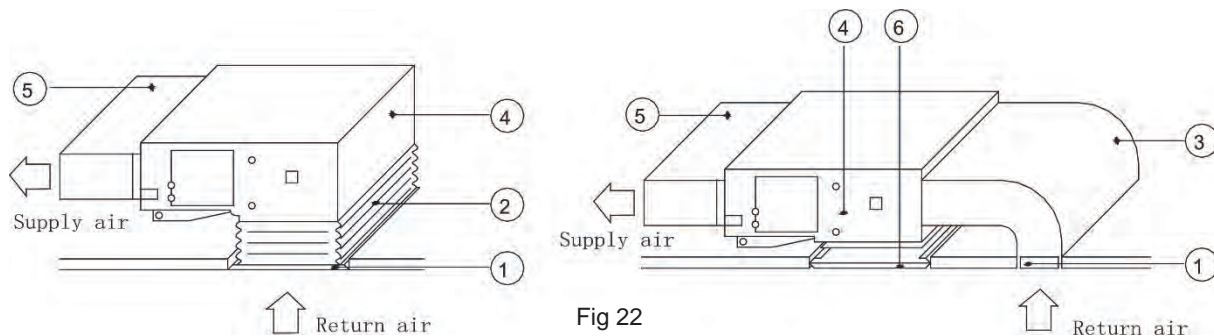

Fig 22

(4) Installation of the Fresh Air Pipe

- (1) When the fresh air pipe is needed to be connected, cut the fresh air baffle as Fig 23. Plug up the gap of the fresh air baffle by sponge if the fresh air duct is not be used.
- (2) Install the round flange so that the fresh air duct can be connected as Fig 24.
- (3) Sealing and heat preservation should be done for both the air pipe and round flange pipe.
- (4) Fresh air should be treated via the air filter.

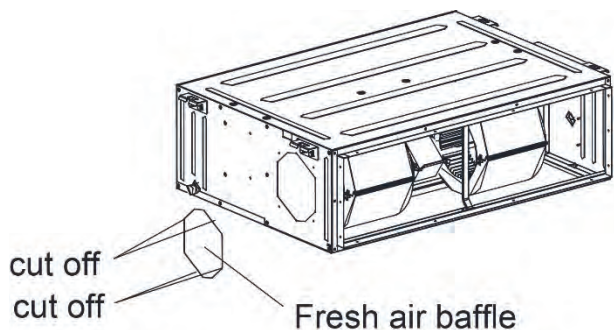

Fig 23

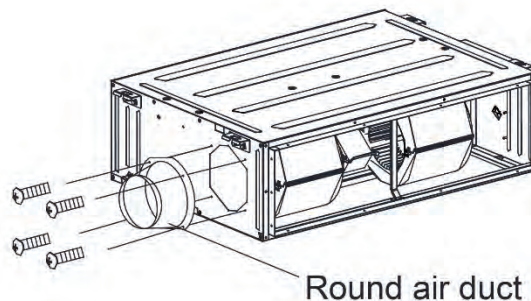

Fig 24

9.5 Installation of Wired Controller

Please refer to User Manual of Wired Controller for the installation details.

NOTICE!

When installation is finished, the unit must be tested and debugged before operation. Please refer to Instruction Manual of ODU for auto addressing and debugging details.

9.6 Wiring Work



WARNING

Before obtaining access to terminals, all supply circuits must be disconnected.

NOTICE

- | |
|--|
| (1) Units must be earthed securely, or it may cause electric shock. |
| (2) Please carefully read the wiring diagram before carry out the wiring work, incorrect wiring could cause malfunction or even damage the unit. |
| (3) The unit should be powered by independent circuit and specific socket. |
| (4) The wiring should be in accordance with related regulations in order to ensure the units reliable running. |
| (5) Install circuit breaker for branch circuit according to related regulations and electrical standards. |
| (6) Keep cable away from refrigerant pipings, compressor and fan motor. |
| (7) The communication wires should be separated from power cord and connection wire between indoor unit |
| (8) Adjust the static pressure via wired controller according to site circumstance. |

(1) Connection of Wire and Patch Board Terminal

1. The connection of wire (as shown in fig 25)

- (1) Strip about 25mm(1 in.) insulation of the wire end by stripping and cutting tool.
- (2) Remove the wiring screws on the terminal board.
- (3) Shape the tail of wire into ring by needle nose plier, and keep the gauge of ring in accordance with screw.
- (4) Use the screwdriver for tightening the terminal.

2. The connection of stranded wire (as shown in fig 26)

- (1) Strip about 10mm (3/8 in.) insulation of the end of stranded wire by stripping and cutting tool.
- (2) Loosen the wiring screws on terminal board.
- (3) Insert the wire into the ring tongue terminal and tighten by crimping tool.
- (4) Use the screwdriver for tightening the terminal.

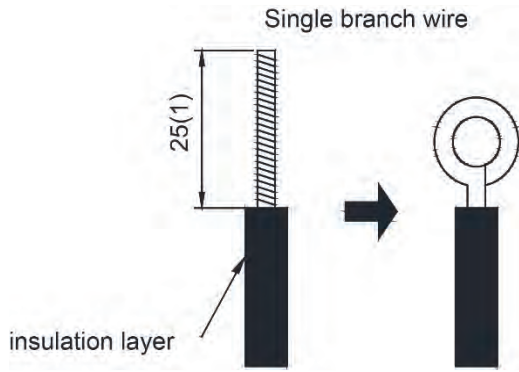

Fig 25

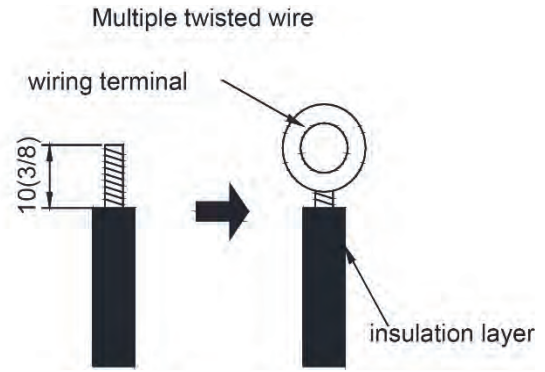

Fig 26

(2) Power Cord Connection

- (1) Detach the electric box lid.
- (2) Let the power cord pass through the wiring through-holes.
- (3) Fix the power card with wiring clamp.
- (4) The wire diameter of power cord can't be less than 18AWG.

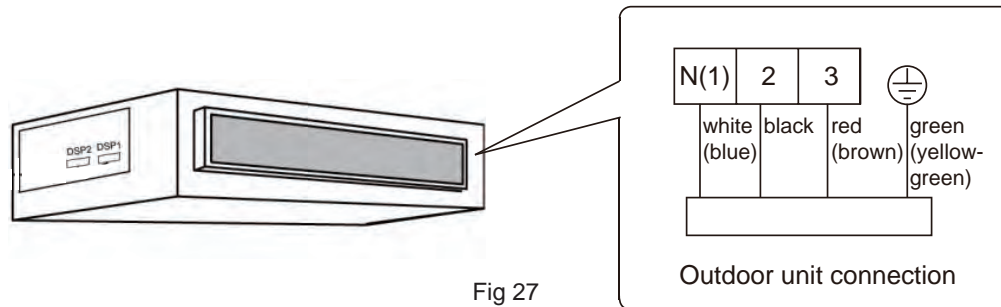

Fig 27

NOTICE!

- Every unit should be equipped with a circuit breaker for short-circuit and overload protection.
- During operation, all indoor units connected to the same outdoor unit system must be kept energized status. Otherwise, the unit can't operate normally.
- Indoor unit quantity n is according to the outdoor unit capacity.
- For units with single-phase power supply.

(3) Wiring of the Signal Line of the Wired Controller

1. Open the cover of the electric box of the indoor unit.
2. Let the signal line go through the rubber ring.
3. Insert the signal line to the four-pin socket on the printed circuit board of the indoor unit.
4. Fix the signal line with the binding wire.

9.7 Adjust after installation

Working range for external static pressure of this series of duct type unit is 0 Pa~275 Pa. For corresponding external static pressure to the respective static pressure notch please see as below. The setting of static pressure for indoor fan can be done via wired controller.

Applicable to: 09K/12K								
Static pressure notch for indoor fan	2	3	4	5	6	7	8	9
External static pressure (Pa)	0	20	40	60	80	100	120	150

Applicable to: 18K/21K/24K								
Static pressure notch for indoor fan	2	3	4	5	6	7	8	9
External static pressure (Pa)	0	30	60	90	120	150	180	200

9.8 Installation and Dismantlement(Wired Controller)

(1)Connection of the Signal Line of the Wired Controller

- Open the cover of the electric control box of the indoor unit.
- Let the single line of the wired controller through the soleplate of wired controller.
- Connect the signal line of the wired controller to the 4-pin socket of the indoor unit.
- The communication distance between the main board and the wired controller can be up to 20 meters (the standard distance is 8 meters)

(2)Installation of the Wired Controller

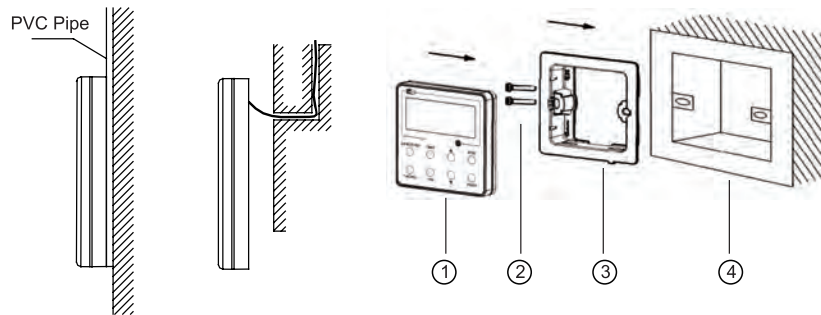

Fig. 28 Accessories for the Installation of the Wired Controller

No.	1	2	3	4
Name	Front Panel of the Wired Controller	Screw M4X25	Soleplate of the Wired Controller	Socket box embedded in the wall

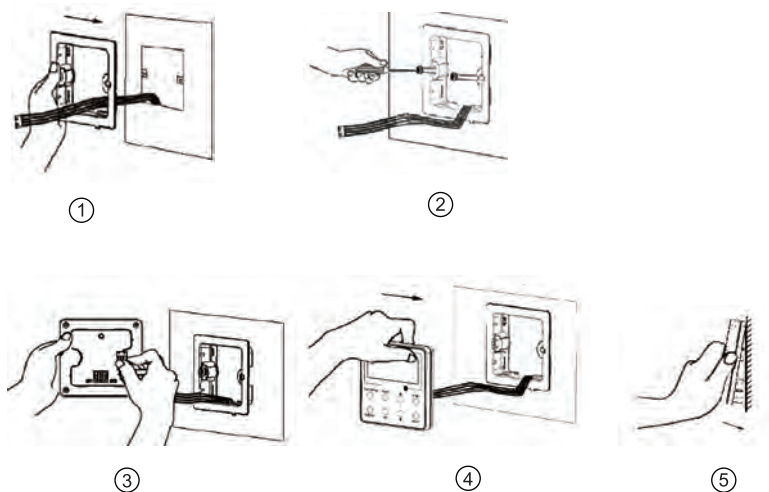

Fig 29

Note:

CN1 is 485 communication interface and it used Wired Controller XE72-44/E for connecting the 4- core communication wire. These two needle stands(CN2/CN3) are used for connecting the smart zone controller. There is no sequence for these two needle stands. You can connect one or two needle stand(s) basing on the requirement.

Fig. 29 shows the installation steps of the wired controller, but there are some issues that need your attention.

1. Prior to the installation, please firstly cut off the power supply of the wire buried in the installation hole, that is, no operation is allowed with electricity during the whole installation.
2. Pull out the four-core twisted pair line from the installation holes and then let it go through the rectangular hole behind the soleplate of the wired controller.
3. Stick the soleplate of wired controller on the wall and then use screw M4×25 to fix soleplate and installation hole on wall together.
4. Insert the four-core twisted pair line into the slot of the wired controller and then buckle the front panel and the soleplate of the wired controller together.

For matching with different models, the patch cord and the connection wire are provided in the packaging box of wired controller. As shown in fig.30.



Fig 30: Schematic diagram of patch cord and connection wire

- If the air conditioner has been installed with the patch cord (fig. 32) used for connecting the wired controller. Only use the connection wire (fig. 31) in the packing box of wired controller. Connect the terminal ② to the terminal ④ of patch cord which has been installed on the air conditioner; insert terminal ① to needle stand CN1 of wired controller. If there's protection terminal ③, pull out the protection terminal at first and then install it.



Fig 31: Schematic diagram of connection wire: Connect terminal ① with wired controller CN1; connect terminal ② with the terminal ④ of patch cord



Fig 32: Schematic diagram of patch cord: Terminal ③ is the protection terminal; connect terminal ④ to the terminal ② of connection wire; connect terminal ⑤ to the terminal of wired controller of air conditioner

- If the air conditioner hasn't been installed with the patch cord used for connecting the wired controller. Use the connection wire and patch cord in the packing box of wired controller. Pull out the protection terminal of patch cord at first, connect the connection wire with the patch cord according to fig. 33, and then insert the terminal ① of connection wire into the needle stand CN1 of wired controller and insert the terminal ⑤ of patch cord into the terminal of wired controller of air conditioner as well.

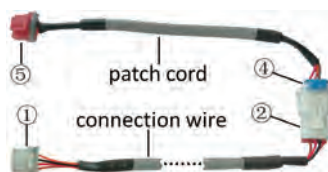

Fig 33: Schematic diagram after the connection wire and the patch cord have been connected: connect the terminal ② of connection wire and the terminal ④ of patch cord

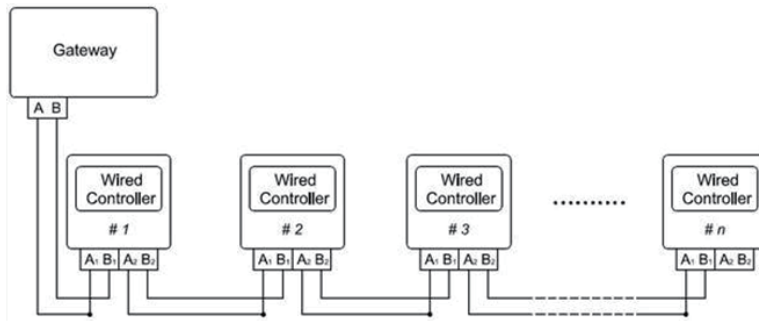

Fig 34

Fig. 34 shows the schematic diagram of control system connection. XE72-44/E can connect the smart zone controller (integrated control system). "n" indicates the number of communication node address (programmable wired controller XE72-44/E). The complete system is composed of the smart zone controller, wired controller XE72-44/E and communication cable. The wired controller XE72-44/E can support 16 communication node addresses at the most ($n \leq 16$).

Terminal A and terminal B of the smart zone controller are respectively connected to the corresponding communication needle stand terminal of the #1 wired controller by the communication cable; the other needle stand of #1 wired controller is connected to the #2 wired controller through the telecommunication cable and so forth until connect to the #n wired controller. Except the last wired controller in the control system (only use CN2 or CN3, and the other one will not be connected), there's no the sequence and the importance for the wired controller. The series number in the figure is only for the sake of clarity.

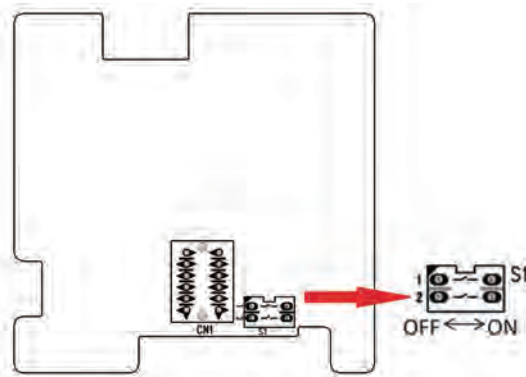

Fig 35

Fig. 35 shows schematic diagram of DIP switch. There is a 2-bit DIP switch on the main board of wired controller XE72-44/E. As for the last #n wired controller in the control system, the 1-bit and the 2-bit of the DIP switch should be manually pulled to position "on" and position "off" respectively. The DIP switches of other wired controllers should be kept at the initial ex-factory status (1-bit and 2-bit are set at position "off").

CAUTION!

Please pay special attention to the followings during the connection to avoid the malfunction of the air conditioning unit due to electromagnetic interference.

1. Separate the signal and communication lines of the wired controller from the power cord and connection lines between the indoor and outdoor unit, with a minimum interval of 20cm, otherwise the communication of the unit will probably work abnormally.
2. If the air conditioning unit is installed where is vulnerable to electromagnetic interference, then the signal and communication lines of the wired controller must be the shielding twisted pair lines.

(3) Dismantlement of the Wired Controller

- Open the cover of the electric control box of the indoor unit.
- Let the single line of the wired controller through the soleplate of wired controller.
- Connect the signal line of the wired controller to the 4-pin socket of the indoor unit.
- The communication distance between the main board and the wired controller can be up to 20 meters (the standard distance is 8 meters)

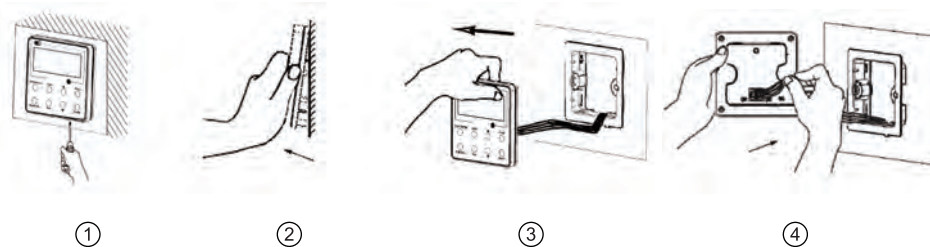

10. Maintenance

10.1 Error Code List

Error code	Malfunction name	AC status	Possible causes
C5	Malfunction of jumper cap	The complete unit stops operation	<ol style="list-style-type: none"> 1. Jumper cap is not installed in control panel; 2. Poor contact of jumper cap; 3. Jumper cap is damaged; 4. The tested circuit of jumper cap on control panel is abnormal.
E6	Communication malfunction between indoor unit and outdoor unit	Cool: compressor stops operation, while indoor fan operates; Heat: all loads stops operation.	See "Communication malfunction"
H5	IPM protection	Cool/Dry: compressor stops operation, while indoor fan operates. Heat: all loads stops operation.	See "IPM protection, over-phase current of compressor"
L3 LA	Malfunction of outdoor fan/ malfunction of DC motor	Cool/Dry: all loads stops operation except indoor fan. Heat: all loads stops operation.	<ol style="list-style-type: none"> 1. Outdoor condenser, air inlet and air outlet are blocked by filth or dirt; 2. Fan is blocked or loosened; 3. Motor or connection wire of motor is damaged; 4. Main board of outdoor unit is damaged; (As for dual-outdoor fan, L3 indicates fan 1; LA indicates fan 2)
H3	Overload protection of compressor	Cool/Dry: compressor stops operation, while indoor fan operates. Heat: all loads stops operation.	<ol style="list-style-type: none"> 1. Overload wire of compressor is loose; 2. The overload protector is damaged. Under normal circumstances, the resistance between both ends of terminal is less than 1ohm. 3. See "Overload protection of compressor , High discharge temperature protection of compressor"
F0	Refrigerant insufficient protection, cut-off protection of refrigerant	Cool: compressor and outdoor fan stops operation, while indoor fan operates; Heat: Compressor, outdoor fan and indoor fan stops operation.	<ol style="list-style-type: none"> 1. Is system cooling under high humidity environment, thus temperature difference of heat transfer is small; 2. Check whether the big valve and small valve of outdoor unit are opened completely; 3. Is the temperature sensor of evaporator of indoor unit loose? 4. Is the temperature sensor of condenser of outdoor unit loose? 5. Is the capillary or the electronic expansion valve blocked? 6. Is refrigerant leaking?
F1	Indoor ambient temperature sensor is open/short-circuited	Cool/Dry: indoor fan operates, while compressor and outdoor fan stops operation; Heat: all loads stops operation.	<ol style="list-style-type: none"> 1. Temperature sensor is not well connected; 2. Temperature sensor is damaged 3. Main board of indoor unit is damaged.
F2	Indoor evaporator temperature sensor is open/short-circuited	Cool/Dry: indoor fan operates, while compressor and outdoor fan stops operation; Heat: all loads stops operation.	<ol style="list-style-type: none"> 1. Temperature sensor is not well connected; 2. Temperature sensor is damaged 3. Main board of indoor unit is damaged.
H6	No feedback from indoor unit's motor	The complete unit stops operation	<ol style="list-style-type: none"> 1. Is the fan blocked? 2. Is the motor terminal loose? 3. Is the connection wire of motor damaged? 4. Is the motor damaged? 5. Is the main board of indoor unit damaged?
LP	Indoor unit and outdoor can be matched with each other	Heat: compressor, outdoor unit and indoor fan stops operation.	Capacity of indoor unit and outdoor unit can't be matched.
C4	Malfunction of jumper cap of outdoor unit	Heat: all loads are stopped; other modes: outdoor unit stops operation.	Jumper cap of outdoor unit hasn't been installed.
b7	Gas valve temperature sensor is ON / short-circuited		<ol style="list-style-type: none"> 1. Temperature sensor is not well connected or damaged; 2. The wire of temperature sensor is damaged, causing short circuit to copper pipe or outer casing; 3. Main board of outdoor unit is damaged.

Error code	Malfunction name	AC status	Possible causes
b5	Liquid valve temperature sensor is ON / short-circuited		<ol style="list-style-type: none"> 1. Temperature sensor is not well connected or damaged; 2. The wire of temperature sensor is damaged, causing short circuit to copper pipe or outer casing; 3. Main board of outdoor unit is damaged.
E1	High pressure protection of system	Cool/Dry: all loads stops operation except indoor fan; Heat: all loads stops operation.	<ol style="list-style-type: none"> 1. Heat exchange of outdoor unit is too dirty, or it blocked the air inlet/outlet; 2. Is power voltage normal; (three-phase unit) 3. Ambient temperature is too high; 4. Wiring of high pressure switch is loose or high pressure switch is damaged; 5. The internal system is blocked; (dirt blockage, ice blockage, oil blockage, angle valve is not completely opened) 6. Main board of outdoor unit is damaged; 7. Refrigerant is too much.
E3	Low pressure/low system pressure protection/ compressor low pressure protection	Cool: compressor, outdoor fan and indoor fan stop operation; Heat: compressor and outdoor fan stop operation at first. About 1min later, indoor fan stops operation; 2mins later, the 4-way valve stop operation.	<ol style="list-style-type: none"> 1. Low pressure switch is damaged; 2. Refrigerant inside the system is insufficient.
E4	High discharge temperature protection of compressor	Cool/Dry: compressor and outdoor fan stops operation, while indoor fan operates; Heat: all loads stops operation.	See "Overload protection of compressor , High discharge temperature protection of compressor"
E5	AC overcurrent protection	Cool/Dry: compressor and outdoor fan stops operation, while indoor fan operates; Heat: all loads stops operation.	<ol style="list-style-type: none"> 1. Power voltage is unstable; 2. Power voltage is too low; 3. System load is too high, which leads to high current; 4. Heat exchange of indoor unit is too dirty, or it blocked the air inlet/outlet; 5. Fan motor operation is abnormal; the fan speed is too low or not functioning; 6. Compressor is blocked; 7. The internal system is blocked; (dirt blockage, ice blockage, oil blockage, angle valve is not completely opened) 8. Main board of outdoor unit is damaged. See "AC overcurrent protection"
E7	Mode shock/sysmte mode shock	Load of indoor unit stops operation (indoor fan, E-heater, swing)	Malfunction of one-to-more system; there may be two indoor units which has set the shock mode, such as one is cooling and the other is heating.
E8	High temperature prevention protection	Cool: compressor stops operation while indoor fan operates; Heat: all loads stops operation.	See "High temperature prevention protection; high power; system isabnormal"
EE	Malfunction of EEPROM	Cool/Dry: compressor stops operation, while indoor fan operates; Heat: all loads stops operation.	Main board of outdoor unit is damaged.
F0	Refrigerant-recovery mode	Cool/Dry: compressor and outdoor fan stops operation, while indoor fan operates.	Refrigerant recovery. The maintenance personnel operate it when he is maintaining the unit.
F3	Outdoor ambient temperature is open/short-circuited	Cool/Dry: compressor and outdoor fan stop operation, while indoor fan operates; Heat: all loads stops operation.	<ol style="list-style-type: none"> 1. Temperature sensor is not connected well or damaged; 2. Temperature sensor wire of outdoor unit is damaged; short circuit between the temperature sensor and copper pipe or outer case 3. Main board of outdoor unit is damaged;

Error code	Malfunction name	AC status	Possible causes
F4	Outdoor condenser temperature sensor is open/short-circuited	Cool/Dry: compressor and outdoor fan stop operation, while indoor fan operates; Heat: after operating for 3mins, all loads stops operation.	1. Temperature sensor is not connected well or damaged; 2. Temperature sensor wire of outdoor unit is damaged; short circuit between the temperature sensor and copper pipe or outer case; 3. Main board of outdoor unit is damaged.
F5	Outdoor air discharge temperature is open/short-circuited	Complete unit stops operation; motor of sliding door is cut off power.	1. The exhaust temperature sensor is not connected well or damaged. 2. Temperature sensor wire of outdoor unit is damaged; short circuit between the temperature sensor and copper pipe or outer case 3. Main board of outdoor unit is damaged;
FC	Malfunction of micro switch	Cool/Dry: compressor stops operation, while indoor fan operates; Heat: all loads stops operation.	1. The sliding door is blocked; 2. Malfunction of the photoelectric inspection panel of sliding door;
H4	System is abnormal	Cool/Dry: all loads stops operation except indoor fan; Heat: all loads stops operation.	See "High temperature prevention protection; high power; system is abnormal"
H7	Desynchronizing of compressor	Cool/Dry: compressor stops operation, while indoor fan operates; Heat: all loads stops operation.	See "Desynchronization diagnosis for compressor"
HC	PFC protection	Cool/Dry: compressor stops operation, while indoor fan operates; Heat: all loads stops operation.	1. The power grid quality is bad; AC input voltage fluctuates sharply; 2. Power plug of air conditioner or wiring board or reactor is not connected reliably; 3. Indoor and outdoor heat exchanger is too dirty, or air inlet/outlet is blocked; 4. Main board of outdoor unit is damaged.
HE	Demagnetization protection of compressor	Cool: compressor and outdoor fan stop operation; Heat: compressor and outdoor fan stop operation at first; about 1min later, indoor fan stops operation.	1. The main board of outdoor unit is damaged; 2. Compressor is damaged;
UF	Communication malfunction between indoor unit and inspection board	Normal operation	1. Poor connection between the indoor unit and the inspection board. 2. The main board of indoor unit is damaged; 3. The inspection board is damaged;
L1	Malfunction of humidity sensor	Compressor, outdoor fan and indoor fan stop operation;	The inspection board is damaged.
L9	High power protection	Cool: compressor and outdoor fan stops operation, while indoor fan operates.	See "High temperature prevention protection; high power; system is abnormal"
Lc	Start-up failed	Cool/Dry: compressor stops, while indoor fan operates; Heat: all loads stops operation.	See "Malfunction diagnosis for failure startup"
Ld	Lost phase	Cool: compressor and outdoor fan stop operation; Heat: compressor and outdoor fan stop operation at first; about 1min later, indoor fan stops operation.	1. The main board of outdoor unit is damaged; 2. The compressor is damaged; 3. The connection wire of compressor is not connected well.
PS	Over-phase current protection of compressor	Cool/Dry: compressor stops operation, while indoor fan operates; Heat: all loads stops operation.	See "Overload protection of compressor , High discharge temperature protection of compressor"

Error code	Malfunction name	AC status	Possible causes
OE	Undefined outdoor unit error	Cool: compressor and outdoor fan stops operation, while indoor fan operates; Heat: compressor, outdoor fan and indoor fan stop operation.	1. Outdoor ambient temperature exceeds the operation range of unit (eg: less than -20°C or more than 60°C for cooling; more than 30°C for heating); 2. Are wires of compressor not connected tightly? 3. Failure startup of compressor? 4. Is compressor damaged? 5. Is main board damaged?
PE	Communication malfunction between the drive board and the main board	Cool: compressor and outdoor fan stops operation; Heat: compressor and outdoor fan stop at first; about 1min later, indoor fan stops operation;	1. The drive board is damaged; 2. The main board of outdoor unit is damaged; 3. The drive board and the main board is not connected well.
PF	Circuit malfunction of module temperature sensor	Cool/Dry: compressor stops operation, while indoor fan operates; Heat: all loads stops operation.	Replace outdoor control board
PG	Module overheating protection	Cool: compressor stops operation, while indoor fan operates; Heat: all loads stops operation.	1. Air inlet / air outlet of outdoor unit are blocked by filth or dirt; 2. Condenser of outdoor unit is blocked by filth or dirt; 3. IPM screw of main board is not tightened; 4. Main board of outdoor unit is damaged;
PH	Malfunction of ambient temperature sensor of drive board	Cool: compressor, outdoor fan and indoor fan stop operation; Heat: compressor and outdoor fan stop operation at first; about 1min later, indoor fan stops operation.	1. The ambient temperature sensor of the drive board is not connected well; 2. Malfunction of the ambient temperature sensor of drive board.
PI	DC bus voltage is too high	Cool/Dry: compressor stops operation, while indoor fan operates; Heat: all loads stops operation.	1. Measure the voltage between position L and position N on the wiring board (XT). If it's higher than 265 VAC, please turn on the unit until the power voltage is decreased to the normal range; 2. If the AC input is normal, please replace the outdoor control board.
PL	DC bus voltage is too low	Cool/Dry: compressor stops operation, while indoor fan operates; Heat: all loads stops operation.	1. Measure the voltage between position L and position N on the wiring board (XT). If it's lower than 150 VAC, please turn on the unit until the power voltage is increased to the normal range; 2. If the AC input is normal, please replace the outdoor control board.
PU	Charging malfunction of capacitor	Cool/Dry: compressor stops operation, while indoor fan operates; Heat: all loads stops operation.	See "Charging malfunction of capacitor"
RF	Malfunction of RF module	Cool: compressor and outdoor fan stop operation; Heat: compressor and outdoor fan stop operation at first; about 1min later, indoor fan stops operation.	1. The connection wire of RF module is not connected well. 2. Malfunction of RF module;
UI	Phase current detection circuit malfunction of	Cool: compressor and outdoor fan stops operation, while indoor fan operates; Heat: compressor, outdoor fan and indoor fan stops operation.	The control board is damaged
U2	Lost phase protection of compressor	Cool: compressor and outdoor fan stop operation; Heat: compressor and outdoor fan stop operation at first; about 1min later, indoor fan stops operation.	1. The main board of outdoor unit is damaged; 2. The compressor is damaged; 3. The connection wire of compressor is not connected well.

Error code	Malfunction name	AC status	Possible causes
U3	DC bus voltage drop malfunction	Cool/Dry: compressor stops operation, while indoor fan operates; Heat: all loads stops operation.	The power voltage is unstable.
U5	Current detection malfunction of unit	Cool: compressor and outdoor fan stops operation, while indoor fan operates; Heat: compressor, outdoor fan and indoor fan stops operation.	1. Is the complete unit lacking of refrigerant? 2. There's malfunction for the circuit of control board of outdoor unit. Replace the control board of outdoor unit.
U7	4-way valve is abnormal	This malfunction occurs when the unit is heating. All loads stops operation.	1. Power voltage is lower than AC175V; 2. Wiring terminal of 4-way valve is loose or broken;3. 4-way valve is damaged. Replace the 4-way valve.
U8	Malfunction of zero-crossing signal of indoor unit	Compressor, outdoor fan and indoor fan stop operation.	1. The power is abnormal; 2. Main board of indoor unit is damaged.
U9	Zero-crossing malfunction of outdoor unit	Cool: compressor stops operation, while indoor fan operates; Heat: all loads stops operation.	Replace the control board of outdoor unit.
E2	Evaporator anti-freezing protection		Not error code, it is the status code in cooling process
E9	Anti cold air protection		Not error code, it is the status code in cooling process
	Defrosting	Heat indicator Flash once/10s	Not error code, it is the status code in cooling process
EA	Refrigerant leak alarm		The air conditioner may have refrigerant leakage.

Analysis or processing of some of the malfunction display:

1. Compressor discharge protection

Possible causes: shortage of refrigerant; blockage of air filter; poor ventilation or air flow short pass for condenser; the system has non-condensing gas (such as air, water etc.); blockage of capillary assy (including filter); leakage inside four-way valve causes incorrect operation; malfunction of compressor; malfunction of protection relay; malfunction of discharge sensor; outdoor temperature too high.
Processing method: refer to the malfunction analysis in the above section.

2. Low voltage overcurrent protection

Possible cause: Sudden drop of supply voltage.

3. Communication malfunction

Processing method: Check if communication signal cable is connected reliably.

4. Sensor open or short circuit

Processing method: Check whether sensor is normal, connected with the corresponding position on the controller and if damage of lead wire is found.

5. Compressor over load protection

Possible causes: insufficient or too much refrigerant; blockage of capillary and increase of suction temp.; improper running of compressor, burning in or stuck of bearing, damage of discharge valve; malfunction of protector.

Processing method: adjust refrigerant amount; replace the capillary; replace the compressor; use universal meter to check if the contactor of compress or is fine when it is not overheated, if not replace the protector.

6. System malfunction

i.e.overload protection. When tube temperature(Check the temperature of outdoor heat exchanger when cooling and check the temperature of indoor heat exchanger when heating) is too high, protection will be activated.

Possible causes: Outdoor temperature is too high when cooling; insufficient outdoor air circulation; refrigerant flow malfunction.
please refer to the malfunction analysis in the previous section for handling method .

7. IPM module protection

Processing method: Once the module malfunction happens,if it persists for a long time and can not be self canceled, cut off the power and turn off the unit,and then re-energize the unit again after about 10 min. After repeating the procedure for sever times, if the malfunction still exists,replace the module.

10.2 Troubleshooting for Main Malfunction

Indoor unit:

1. Malfunction of Temperature Sensor F1, F2

Main detection points:

- Is the wiring terminal between the temperature sensor and the controller loosened or poorly contacted?
- Is there short circuit due to trip-over of the parts?
- Is the temperature sensor broken?
- Is mainboard broken?

Malfunction diagnosis process:

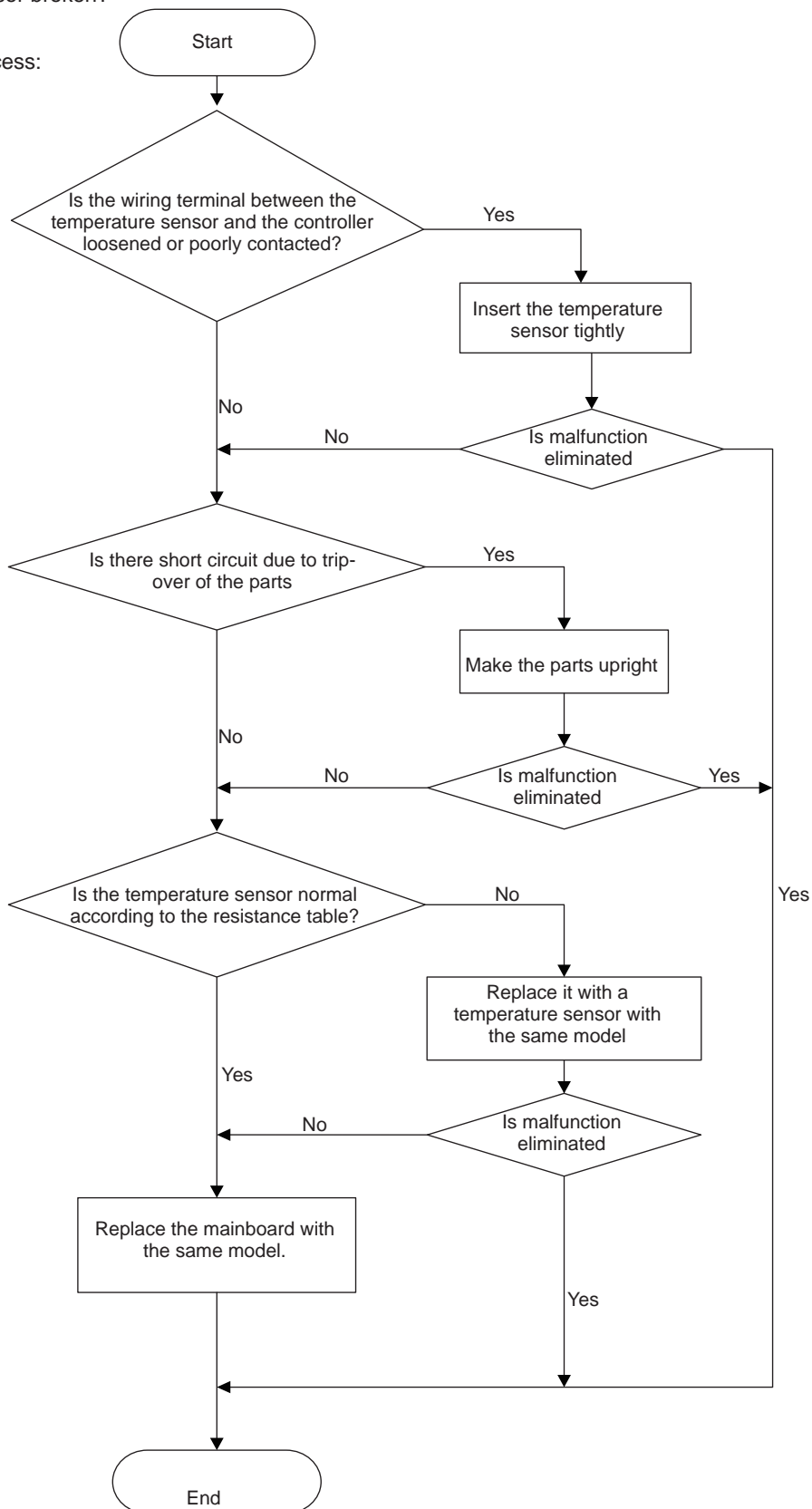

4. Water overflow protection E9

Malfunction diagnosis process:

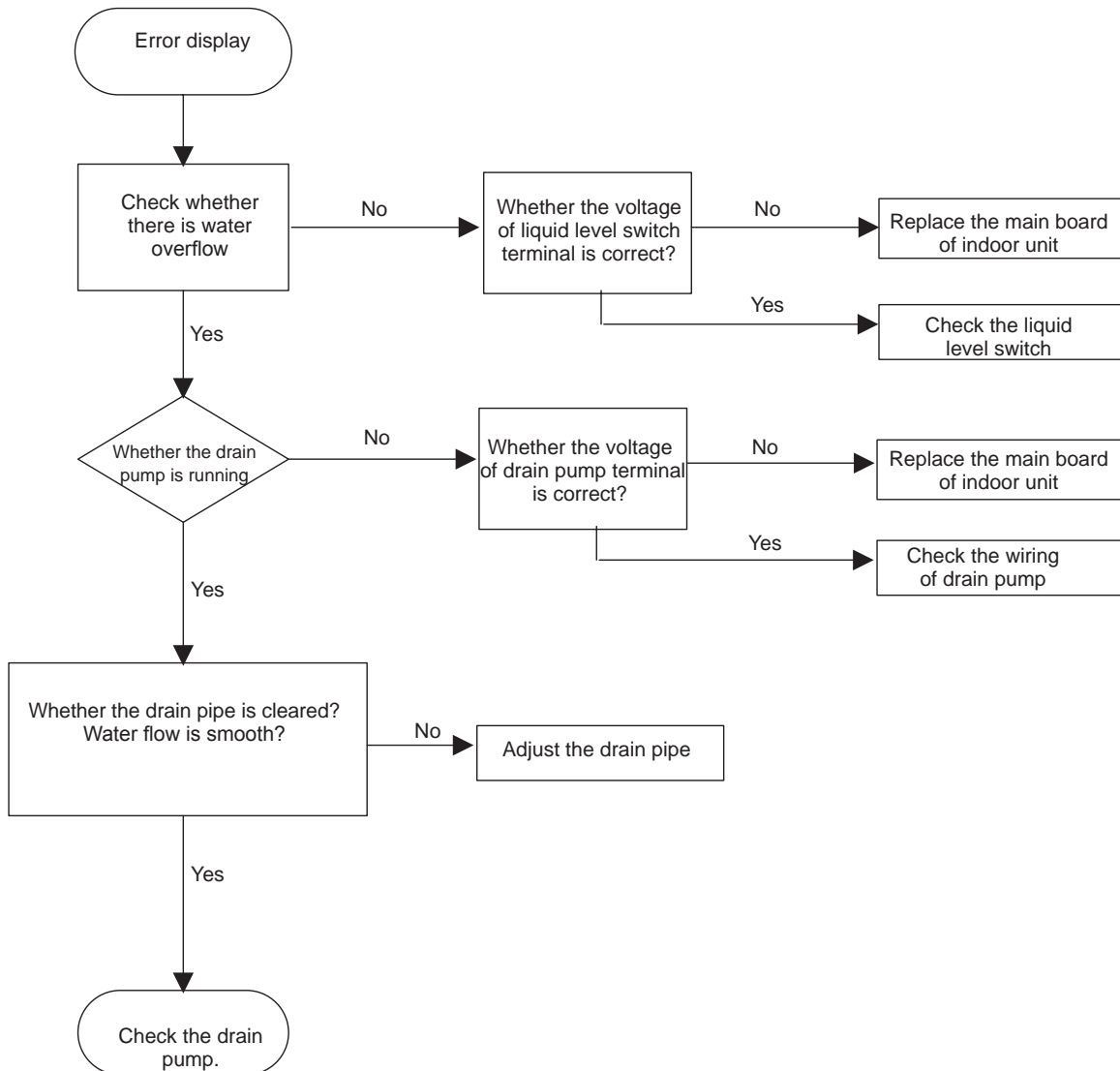

10.3 Maintenance Method for Normal Malfunction

1. Air Conditioner can't be Started Up

Possible Causes	Discriminating Method (Air conditioner Status)	Troubleshooting
No power supply, or poor connection for power plug	After energization, operation indicator isn't bright and the buzzer can't give out sound	Confirm whether it's due to power failure. If yes, wait for power recovery. If not, check power supply circuit and make sure the power plug is connected well.
Wrong wire connection between indoor unit and outdoor unit, or poor connection for wiring terminals	Under normal power supply circumstances, operation indicator isn't bright after energization	Check the circuit according to circuit diagram and connect wires correctly. Make sure all wiring terminals are connected firmly
Electric leakage for air conditioner	After energization, room circuit breaker trips off at once	Make sure the air conditioner is grounded reliably Make sure wires of air conditioner is connected correctly Check the wiring inside air conditioner. Check whether the insulation layer of power supply cord is damaged; if yes, place the power supply cord.
Model selection for air switch is improper	After energization, air switch trips off	Select proper air switch

2. Poor Cooling (Heating) for Air Conditioner

Possible Causes	Discriminating Method (Air conditioner Status)	Troubleshooting
Set temperature is improper	Observe the set temperature on remote controller	Adjust the set temperature
Rotation speed of the IDU fan motor is set too low	Small wind blow	Set the fan speed at high or medium
Filter of indoor unit is blocked	Check the filter to see its blocked	Clean the filter
Installation position for indoor unit and outdoor unit is improper	Check whether the installation position is proper according to installation requirement for air conditioner	Adjust the installation position, and install the rainproof and sunproof for outdoor unit
Refrigerant is leaking	Discharged air temperature during cooling is higher than normal discharged wind temperature; Discharged air temperature during heating is lower than normal discharged wind temperature; Units pressure is much lower than regulated range	Find out the leakage causes and deal with it. Add refrigerant.
Malfunction of 4-way valve	Blow cold wind during heating	Replace the 4-way valve
Malfunction of capillary	Discharged air temperature during cooling is higher than normal discharged wind temperature; Discharged air temperature during heating is lower than normal discharged wind temperature; Unit pressure is much lower than regulated range. If refrigerant isn't leaking, part of capillary is blocked	Replace the capillary
Flow volume of valve is insufficient	The pressure of valves is much lower than that stated in the specification	Open the valve completely
Malfunction of horizontal louver	Horizontal louver can't swing	Refer to point 3 of maintenance method for details
Malfunction of the IDU fan motor	The IDU fan motor can't operate	Refer to troubleshooting for H6 for maintenance method in details
Malfunction of the ODU fan motor	The ODU fan motor can't operate	Refer to point 4 of maintenance method for details
Malfunction of compressor	Compressor can't operate	Refer to point 5 of maintenance method for details

3. Horizontal Louver can't Swing

Possible Causes	Discriminating Method (Air conditioner Status)	Troubleshooting
Wrong wire connection, or poor connection	Check the wiring status according to circuit diagram	Connect wires according to wiring diagram to make sure all wiring terminals are connected firmly
Stepping motor is damaged	Stepping motor can't operate	Repair or replace stepping motor
Main board is damaged	Others are all normal, while horizontal louver can't operate	Replace the main board with the same model

4. ODU Fan Motor can't Operate

Possible causes	Discriminating method (air conditioner status)	Troubleshooting
Wrong wire connection, or poor connection	Check the wiring status according to circuit diagram	Connect wires according to wiring diagram to make sure all wiring terminals are connected firmly
Capacity of the ODU fan motor is damaged	Measure the capacity of fan capacitor with an universal meter and find that the capacity is out of the deviation range indicated on the nameplate of fan capacitor.	Replace the capacity of fan
Power voltage is a little low or high	Use universal meter to measure the power supply voltage. The voltage is a little high or low	Suggest to equip with voltage regulator
Motor of outdoor unit is damaged	When unit is on, cooling/heating performance is bad and ODU compressor generates a lot of noise and heat.	Change compressor oil and refrigerant. If no better, replace the compressor with a new one

5. Compressor can't Operate

Possible causes	Discriminating method (air conditioner status)	Troubleshooting
Wrong wire connection, or poor connection	Check the wiring status according to circuit diagram	Connect wires according to wiring diagram to make sure all wiring terminals are connected firmly
Capacity of compressor is damaged	Measure the capacity of fan capacitor with an universal meter and find that the capacity is out of the deviation range indicated on the nameplate of fan capacitor.	Replace the compressor capacitor
Power voltage is a little low or high	Use universal meter to measure the power supply voltage. The voltage is a little high or low	Suggest to equip with voltage regulator
Coil of compressor is burnt out	Use universal meter to measure the resistance between compressor terminals and it's 0	Repair or replace compressor
Cylinder of compressor is blocked	Compressor can't operate	Repair or replace compressor

6. Air Conditioner is Leaking

Possible causes	Discriminating method (air conditioner status)	Troubleshooting
Drain pipe is blocked	Water leaking from indoor unit	Eliminate the foreign objects inside the drain pipe
Drain pipe is broken	Water leaking from drain pipe	Replace drain pipe
Wrapping is not tight	Water leaking from the pipe connection place of indoor unit	Wrap it again and bundle it tightly

7. Abnormal Sound and Vibration

Possible causes	Discriminating method (air conditioner status)	Troubleshooting
When turn on or turn off the unit, the panel and other parts will expand and there's abnormal sound	There's the sound of "PAPA"	Normal phenomenon. Abnormal sound will disappear after a few minutes.
When turn on or turn off the unit, there's abnormal sound due to flow of refrigerant inside air conditioner	Water-running sound can be heard	Normal phenomenon. Abnormal sound will disappear after a few minutes.
Foreign objects inside the indoor unit or there're parts touching together inside the indoor unit	There's abnormal sound fro indoor unit	Remove foreign objects. Adjust all parts position of indoor unit, tighten screws and stick damping plaster between connected parts
Foreign objects inside the outdoor unit or there're parts touching together inside the outdoor unit	There's abnormal sound fro outdoor unit	Remove foreign objects. Adjust all parts position of outdoor unit, tighten screws and stick damping plaster between connected parts
Short circuit inside the magnetic coil	During heating, the way valve has abnormal electromagnetic sound	Replace magnetic coil
Abnormal shake of compressor	Outdoor unit gives out abnormal sound	Adjust the support foot mat of compressor, tighten the bolts
Abnormal sound inside the compressor	Abnormal sound inside the compressor	If add too much refrigerant during maintenance, please reduce refrigerant properly. Replace compressor for other circumstances.

11. Exploded View and Parts List

DUC09HP230V1R32AH DUC12HP230V1R32AH

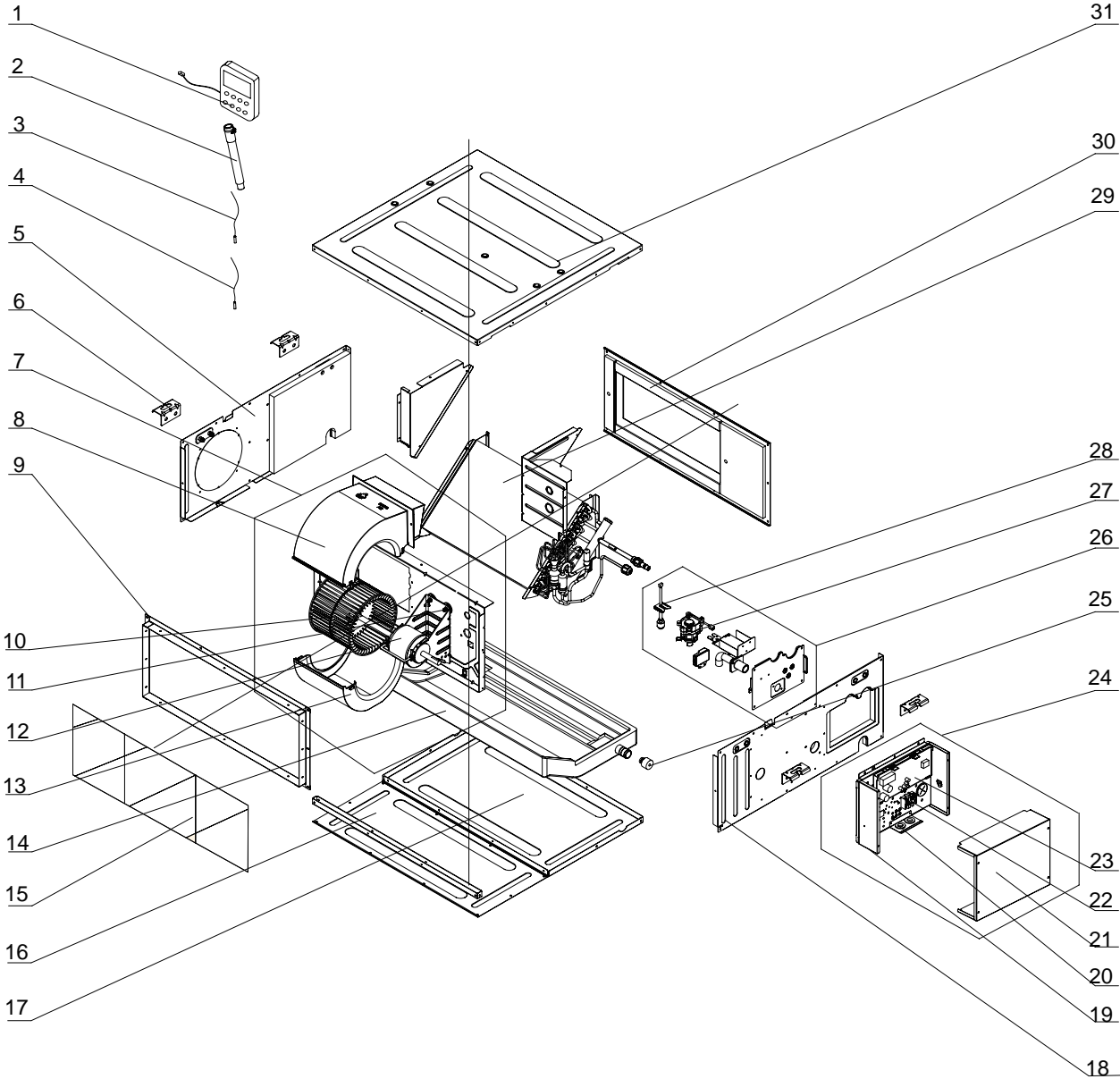

The component picture is only for reference; please refer to the actual product.

NO.	Description
1	Display Board
2	Drain Hose Sub-Assy
3	Temperature Sensor
4	Temperature Sensor
5	Right Side Plate Assy
6	Hook
7	Centrifugal Fan Assy
8	Propeller Housing(Upper)
9	Return Air Frame Sub-Assy
10	Centrifugal Fan
11	Supporter(Fan motor)
12	Brushless DC Motor
13	Propeller Housing(Lower)
14	Foam Sub-assy
15	Filter Sub-Assy
16	Cover Of Air-In

NO.	Description
17	Bottom Cover Plate
18	Left Side Plate Assy
19	Electric Box Sub-Assy
20	Cable Cross Loop
21	Electric Box Cover
22	Terminal Board
23	Main Board
24	Electric Box Assy
25	Choke Plug Of Drain Pipe
26	Seal Plate Assy
27	Water Pump
28	Water Level Switch
29	Evaporator Assy
30	Air Outlet Frame Assy
31	Top Cover Board Assy

Some models may not contain some parts, please refer to the actual product.

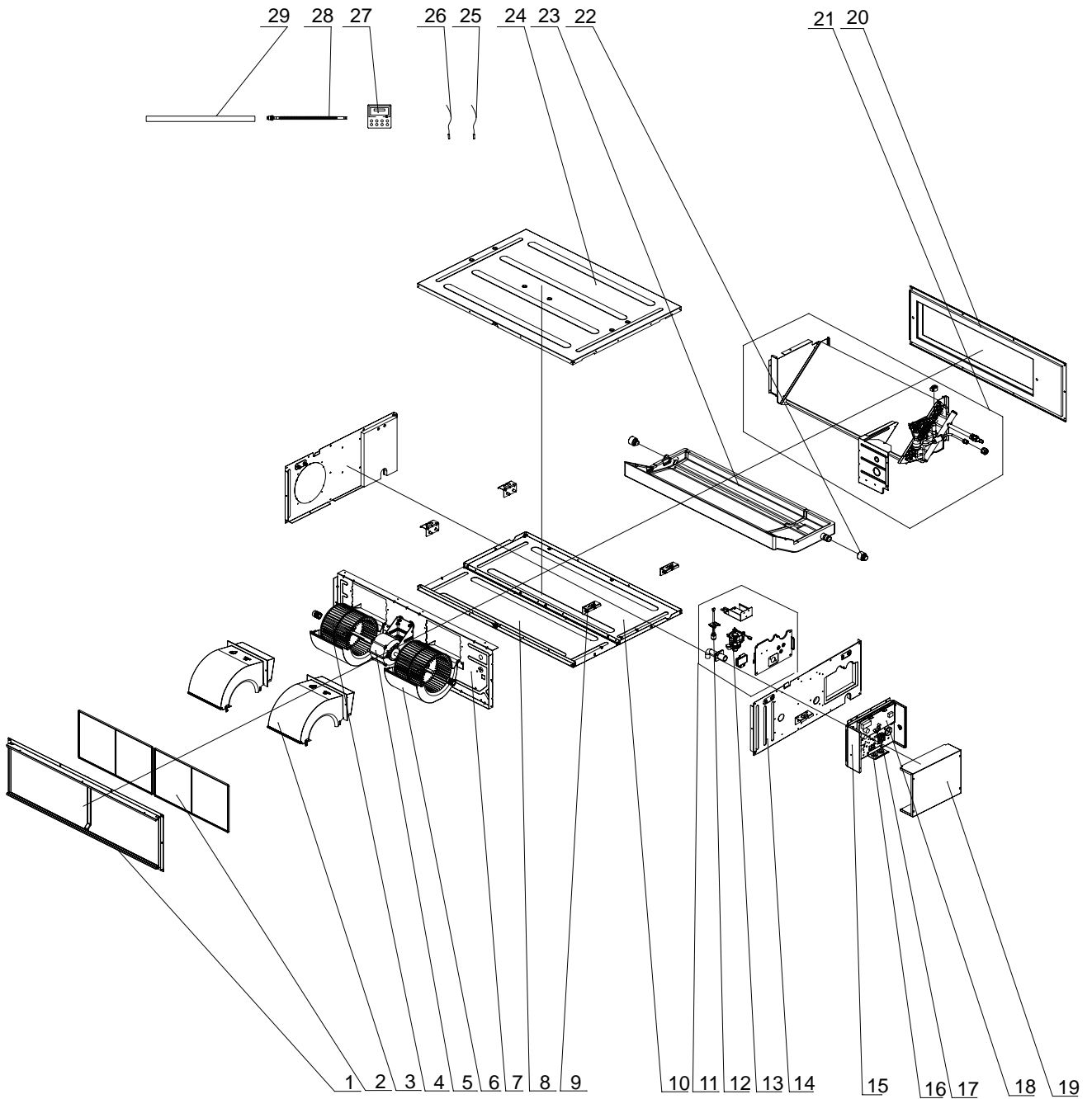

The component picture is only for reference; please refer to the actual product.

NO.	Description
1	Air in Frame Assy
2	Filter Sub-Assy
3	Propeller Housing(Upper)
4	Centrifugal Fan
5	Brushless DC Motor
6	Propeller Housing(Lower)
7	Blower Mounting Plate Sub-Assy
8	Cover Of Air-In
9	Hook
10	Bottom Cover Plate
11	Seal plate Assy
12	Water Level Switch
13	Water Pump
14	Left Side Plate Assy
15	Electric Box Assy

NO.	Description
16	Cable Cross Loop
17	Terminal Board
18	Main Board
19	Electric Box Cover
20	Air Outlet Frame Assy
21	Evaporator Assy
22	Choke Plug of Drain Pipe
23	Foam Sub-assy
24	Top Cover Board Assy
25	Temperature Sensor
26	Temperature Sensor
27	Display Board
28	Corrugated Pipe
29	Drain Hose Sub-Assy

Some models may not contain some parts, please refer to the actual product.

12. Removal Procedure

Caution: discharge the refrigerant completely before removal.

Motor and fan

Precondition: The power supply has been disconnected.

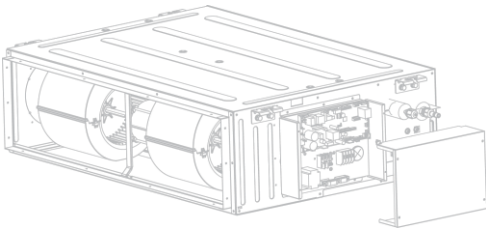
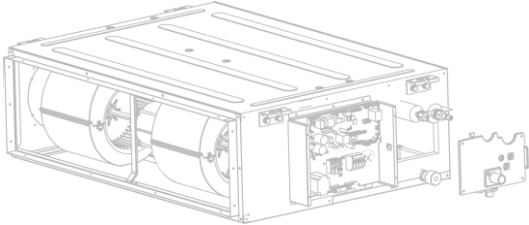
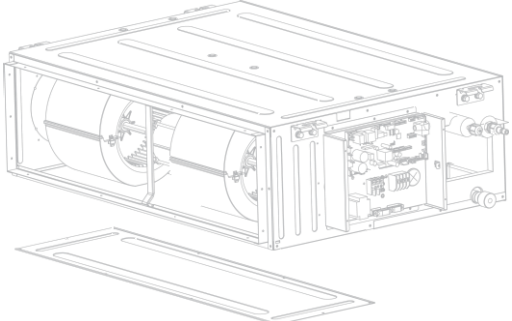
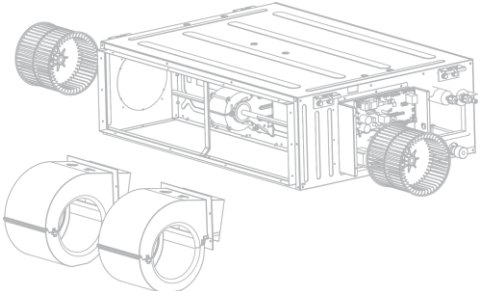
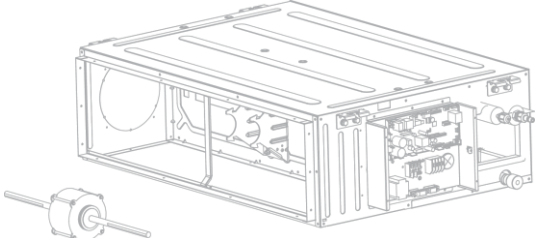
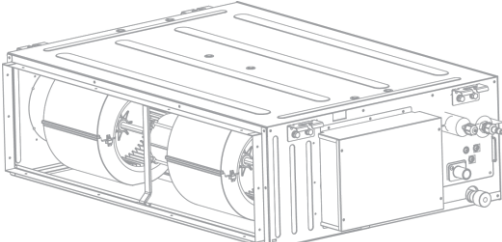
Step	Diagram	Operation Procedure
1.Remove the line connecting to the motor.		<ul style="list-style-type: none"> ●Use a screwdriver to unscrew the electric box cover. ●Remove from the master board the line connecting to the motor and remove the tie.
2. Disassemble the seal plate and cover plate.		<ul style="list-style-type: none"> ●Use a screwdriver to unscrew the seal plate and cover plate and then remove them.
3.Remove the grille.		<ul style="list-style-type: none"> ●Use a screwdriver to unscrew the cover plate component.
4. Remove the centrifugal fan.		<ul style="list-style-type: none"> ●Use a screwdriver to unscrew the front volute casing and then remove the volute casing.
5. Remove the motor.		<ul style="list-style-type: none"> ●Remove the motor from the support and remove the centrifugal fan from the motor axle. Then, remove the motor. ●For motors that are accompanied with supports, the supports need removing as well.
6. Install a new motor.		<ul style="list-style-type: none"> ●Assemble units based on the reverse order of this procedure and power on the units for test.



JF00305639



GREE ELECTRIC APPLIANCES, INC. OF ZHUHAI

Add: West Jinji Rd, Qianshan, Zhuhai, Guangdong, China, 519070

Tel: (+86-756) 8522219

Fax: (+86-756) 8669426

E-mail: global@cn.gree.com

For product improvement, specifications and appearance in this manual are subject to change without prior notice.