



Owner's Manual

Original Instructions

Ducted Type Indoor Unit



Thank you for choosing our product.
Please read this Owner's Manual carefully before operation and retain it for future reference.
If you have lost the Owner's Manual, please contact the local agent or visit www.gree.com or send an email to global@cn.gree.com for the electronic version.

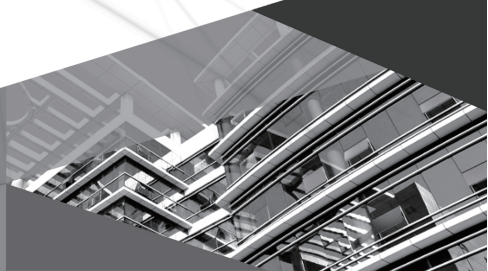

Indoor Unit	Indoor Unit
GFH(30)CCXH-D6DNA1G/I	DUC30HP230V1R32AH

Contents

1 Operation and Maintenance	1
2 Product Introduction	5
2.1 Names of Key Components	5
2.2 Rated Working Condition	5
3 Preparations for Installation	6
3.1 Location for Installation	6
3.2 Wiring Requirements	7
4 Installation Instructions	8
4.1 Installation of Indoor Unit	8
4.2 Refrigerant Pipe Connection	10
4.3 Drainage Pipe Installation and Drainage System Testing	11
4.4 Installation of Air Duct	14
4.5 Installation of Wired Controller	17
5 Wiring Work	17
5.1 Connection of Wire and Patch Board Terminal	17
5.2 Power Cord Connection	18
5.3 Wiring of the Signal Line of the Wired Controller	18
6 Setting of External Static Pressure	19
7 Routine Maintenance	19
7.1 Maintenance before the Seasonal Use	19
7.2 Maintenance after the Seasonal Use	19
8 Table of Error Codes for Indoor Unit	20
9 Troubleshooting	21
10 Specialist's Manual	22

**DANGER**

Indicates a hazardous situation that, if not avoided, will result in death or serious injury.

**WARNING**

Indicates a hazardous situation that, if not avoided, could result in death or serious injury.

**CAUTION**

Indicates a hazardous situation that, if not avoided, may result in minor or moderate injury.

NOTICE

Indicates important but not hazard-related information, used to indicate risk of property damage.



Indicates a hazard that would be assigned a signal word **WARNING** or **CAUTION**.

Manufacturer will bear no responsibilities when personal injury or property loss is caused by the following reasons.

1. Damage the product due to improper use or misuse of the product;
2. Alter, change, maintain or use the product with other equipment without abiding by the instruction manual of manufacturer;
3. After verification, the defect of product is directly caused by corrosive gas;
4. After verification, the defects are due to improper operation during transportation of product;
5. Operate, repair, maintain the unit without abiding by instruction manual or related regulations;
6. After verification, the problem or dispute is caused by the quality specification or performance of parts and components that produced by other manufacturers;
7. The damage is caused by natural calamities, bad using environment or force majeure.







Please read this owner's manual carefully before operating the unit and keep it carefully for consultation.



Only use the air conditioner as instructed in this booklet. These instructions are not intended to cover every possible condition and situation. As with any electrical household appliance, common sense and caution are therefore always recommended for installation, operation and maintenance.

The refrigerator

 <p>Refrigerant Safety Group A2L Appliance filled with flammable magas R32.</p>	 <p>Before install the appliance, read the installation manual first.</p>
 <p>Before use the appliance, read the owner's manual first.</p>	 <p>Before repair the appliance, read the service manual first.</p>

- To realize the function of the air conditioner unit, a special refrigerant circulates in the system. The used refrigerant is the fluoride R32, which is specially cleaned. The refrigerant is flammable and inodorous. Furthermore, it can lead to explosion under certain conditions. But the flammability of the refrigerant is very low. It can be ignited only by fire.
- Compared to common refrigerants, R32 is a nonpolluting refrigerant with no harm to the ozonosphere. The influence upon the greenhouse effect is also lower. R32 has got very good thermodynamic features which lead to a really high energy efficiency. The units there fore need a less filling.

WARNING

- Appliance filled with flammable gas R32.
- Appliance shall be installed, operated and stored in a room with a floor area not less than 7.1m² (76.5ft²)
- The appliance shall be stored in a room without continuously operating ignition sources. (for example: open flames, an operating gas appliance or an operating electric heater.)
- The appliance shall be stored in a well-ventilated area where the room size corresponds to the room area as specified for operation.
- The appliance shall be stored so as to prevent mechanical damage from occurring.
- Ducts connected to an appliance shall not contain an ignition source.
- Keep any required ventilation openings clear of obstruction.
- Do not pierce or burn.
- Be aware that refrigerants may not contain an odour.
- Do not use means to accelerate the defrosting

process or to clean, other than those recommended by the manufacturer.



- Servicing shall be performed only as recommended by the manufacturer.
- Should repair be necessary, contact your nearest authorized Service Centre. Any repairs carried out by unqualified personnel may be dangerous.
- Compliance with national gas regulations shall be observed.
- Read specialist's manual.



≥ 7.1m²(76.5ft²)



Refrigerant Safety Group
A2L

Safety operation of flammable refrigerant

Qualification of workers

Qualification of the working personnel for maintenance, service and repair operations should according to UL 60335-2 -40、CAN/C-SA-C22.2 No. 60335-2-40: 22 Annex HH.. Every working procedure that affects safety means shall only be carried out by competent persons according to Annex HH. Special training additional to usual refrigerating equipment repair procedures is required when equipment with FLAMMABLE REFRIGERANTS is affected.

Installation notes

- The air conditioner must be installed in a room that is larger than the minimum room area. The minimum room area is shown on the nameplate or following table a.
- It is not allowed to drill hole or burn the connection pipe.
- Leak test is a must after installation.

Safety operation of flammable refrigerant

table a - Minimum room area (m²)

Based on UL 60335-2-40 requirements
The following installation height and area for customer reference.

Charge amount (kg)	Installation height(m)			
	1.8	2.2	2.5	3
	Minimum room area (m ²)			
<1.836	/	/	/	/
1.836~2.7	9.8	8.1	7.1	5.9
2.8	10.2	8.4	7.4	6.2
2.9	10.6	8.7	7.6	6.4

Maintenance notes

- Check whether the maintenance area or the room area meet the requirement of the nameplate.
 - It's only allowed to be operated in the rooms that meet the requirement of the nameplate.
- Check whether the maintenance area is well-ventilated.
 - The continuous ventilation status should be kept during the operation process.
- Check whether there is fire source or potential fire source in the maintenance area.
 - The naked flame is prohibited in the maintenance area; and the "no smoking" warning board should be hanged.
- Check whether the appliance mark is in good condition.
 - Replace the vague or damaged warning mark.

Welding

- If you should cut or weld the refrigerant system pipes in the process of maintaining, please follow the steps as below:
 - a. Shut down the unit and cut power supply
 - b. Eliminate the refrigerant
 - c. Vacuuming
 - d. Clean it with N₂ gas
 - e. Cutting or welding
 - f. Carry back to the service spot for welding
- The refrigerant should be recycled into the specialized storage tank.
- Make sure that there isn't any naked flame near the outlet of the vacuum pump and it's well-ventilated.

Filling the refrigerant

- Use the refrigerant filling appliances specialized for R32. Make sure that different kinds of refrigerant won't contaminate with each other.
- The refrigerant tank should be kept upright at the time of filling refrigerant.
- Stick the label on the system after filling is finished (or haven't finished).
- Don't overfilling.
- After filling is finished, please do the leakage detection before test running; another time of leak detection should be done when it's removed.

Safety instructions for transportation and storage

- Please use the flammable gas detector to check before unload and open the container.
- No fire source and smoking.
- According to the local rules and laws.

Safety of Construction

- For appliances using FLAMMABLE REFRIGERANTS, all joints made in the installation between parts of the REFRIGERATING SYSTEM, with at least one part charged, shall be made in accordance with the following:
 - A brazed, welded, or mechanical connection shall be made before opening the valves to permit refrigerant to flow between the REFRIGERATING SYSTEM parts. A vacuum valve shall be provided to evacuate the interconnecting pipe or any uncharged REFRIGERATING SYSTEM part.
 - Mechanical connectors used indoors shall comply with ISO 14903. When mechanical connectors are reused indoors, sealing parts shall be renewed. When flared joints are reused indoors, the flare part shall be refabricated.
 - Refrigerant tubing shall be protected or enclosed to avoid damage.
 - Flexible refrigerant connectors (such as connecting lines between the indoor and outdoor unit) that may be displaced during NORMAL OPERATION shall be protected against mechanical damage.

Safety operation of flammable refrigerant

Pressure test and leak detect

- After completion of field piping for split systems, the field pipework shall be pressure tested with an inert gas and then vacuum tested prior to refrigerant charging, according to the following requirements.

The minimum test pressure for the low side of the system shall be the low side design pressure and the minimum test pressure for the high side of the system shall be the high side design pressure, unless the high side of the system, cannot be isolated from the low side of the system in which case the entire system shall be pressure tested to the low side design pressure.

- Field-made refrigerant joints indoors shall be tightness tested. The test method shall have a sensitivity of 5 grams per year of refrigerant or better under a pressure of at least 0,25 times the maximum allowable pressure. No leak shall be detected.

magnetic interference, chemical substances (such as chemical plants, etc.), flammable gas, combustible and explosive gas and smog, etc.

- Avoid using items containing ethanol (such as perfume, etc.) and smog-producing items (such as cigarettes, etc.) near the refrigerant sensor, otherwise it will lead to abnormal conditions such as false alarms of the refrigerant sensor. If such phenomenon occurs, please contact the after-sales service team for maintenance.
- Only applicable to refrigerant sensor models.

Notices for using refrigerant sensor

- The refrigerant sensor can monitor whether R32 refrigerant leaks in real time. When the leakage of R32 refrigerant is detected, the sensor will trigger the alarm and emit a buzzer, and the indoor unit will display "EA" code. Meanwhile, the outdoor unit will stop running.
- In case of refrigerant leakage, please open the window immediately for ventilation to reduce the concentration of refrigerant in the room. Meanwhile, check the room to ensure that there is no fire source. After completing the above operations, please leave the room and go to the safe place, and then contact the after-sales service team for maintenance.
- When the refrigerant sensor reaches its service life or is damaged, the indoor unit will display "FE" code. Please contact the after-sales service team to replace the refrigerant sensor.
- Avoid oil and water splashing into the refrigerant sensor, otherwise it may cause damage to the refrigerant sensor.
- Avoid using it in the environment with electro-



1 Operation and Maintenance

- This appliance can be used by children aged from 8 years and above and persons with reduced physical, sensory or mental capabilities or lack of experience and knowledge if they have been given supervision or instruction concerning use of the appliance in a safe way and understand the hazards involved.
- Children shall not play with the appliance.
- Cleaning and user maintenance shall not be made by children without supervision.
- Do not connect air conditioner to multi-purpose socket. Otherwise, it may cause fire hazard.
- Do disconnect power supply when cleaning air conditioner. Otherwise, it may cause electric shock.
- If the supply cord is damaged, it must be replaced by the manufacturer, its service agent or similarly qualified persons in order to avoid a hazard.
- Do not wash the air conditioner with water to avoid electric shock.
- Do not spray water on indoor unit. It may cause electric shock or malfunction.
- After removing the filter, do not touch fins to avoid injury.
- Do not use fire or hair dryer to dry the filter to avoid deformation or fire hazard.
- Maintenance must be performed by qualified professionals. Otherwise, it may cause personal injury or damage.
- Do not repair air conditioner by yourself. It may cause electric shock or damage. Please contact dealer when you need to repair air conditioner.
- Do not extend fingers or objects into air inlet or air outlet. It may cause personal injury or damage.
- Do not block air outlet or air inlet. It may cause malfunction.
- Do not spill water on the remote controller, otherwise the remote controller may be broken.
- When below phenomenon occurs, please turn off air conditioner and disconnect power immediately, and then contact the dealer or qualified professionals for service.
 - Power cord is overheating or damaged.
 - There's abnormal sound during operation.
 - Circuit break trips off frequently.
 - Air conditioner gives off burning smell.
 - Indoor unit is leaking.



- If the air conditioner operates under abnormal conditions, it may cause malfunction, electric shock or fire hazard.
- When turning on or turning off the unit by emergency operation switch, please press this switch with an insulating object other than metal.
- Do not step on top panel of outdoor unit, or put heavy objects. It may cause damage or personal injury.
- For appliances made up of more than one factory made assembly specified by the manufacturer to be used together, instructions shall be provided for completing the assembly to ensure compliance with the requirements.

Attachment

- Installation must be performed by qualified professionals. Otherwise, it may cause personal injury or damage.
- Must follow the electric safety regulations when installing the unit.
- According to the local safety regulations, use qualified power supply circuit and circuit break.
- Do install the circuit break. If not, it may cause malfunction.
- Means for disconnection must be incorporated in the fixed wiring in accordance with the wiring rules.
- Including an circuit break with suitable capacity, please note the following table. Air switch should be included magnet buckle and heating buckle function, it can protect the circuit-short and overload.
- Air Conditioner should be properly grounded. Incorrect grounding may cause electric shock.
- Don't use unqualified power cord.
- Make sure the power supply matches with the requirement of air conditioner. Unstable power supply or incorrect wiring may result in electric shock, fire hazard or malfunction. Please install proper power supply cables before using the air conditioner.
- Properly connect the live wire, neutral wire and grounding wire of power socket.
- Be sure to cut off the power supply before proceeding any work related to electricity and safety.
- Do not put through the power before finishing installation.
- If the supply cord is damaged, it must be replaced by the manufacturer, its service agent or similarly qualified persons in order to avoid a hazard.
- The temperature of refrigerant circuit will be high, please keep the interconnection cable away from the copper tube.



- The appliance shall be installed in accordance with national wiring regulations.
- Installation must be performed in accordance with the requirement of NEC and CEC by authorized personnel only.
- The air conditioner is the first class electric appliance. It must be properly grounding with specialized grounding device by a professional. Please make sure it is always grounded effectively, otherwise it may cause electric shock.
- The yellow-green wire in air conditioner is grounding wire, which can't be used for other purposes.
- The grounding resistance should comply with national electric safety regulations.
- The appliance must be positioned so that the plug is accessible.
- All wires of indoor unit and outdoor unit should be connected by a professional.
- If the length of power connection wire is insufficient, please contact the supplier for a new one. Avoid extending the wire by yourself.
- For the air conditioner with plug, the plug should be reachable after finishing installation.
- For the air conditioner without plug, an circuit break must be installed in the line.
- If you need to relocate the air conditioner to another place, only the qualified person can perform the work. Otherwise, it may cause personal injury or damage.
- Select a location which is out of reach for children and far away from animals or plants. If it is unavoidable, please add the fence for safety purpose.
- The indoor unit should be installed close to the wall.
- Before operation, please confirm whether power specification complies with that on nameplate.
- Before cleaning or maintaining the air conditioner, please turn off air conditioner and pull out the power plug.
- Make sure the power cord hasn't been pressed by hard objects.
- Do not pull or drag the power cord to pull out the power plug or move the air conditioner.
- Do not insert or pull out the power plug with wet hands. Please use the grounded power. Make sure the grounding is reliable.
- If the SUPPLY CORD is damaged, it must be replaced by the manufacturer, its service agent or similarly qualified persons in order to avoid a hazard.
- If abnormal condition occurs (e. g. burned smell), please disconnect power at once and then contact local dealer.
- When nobody is taking care of the unit, please turn it off and remove the power plug or disconnect power.



- Do not splash or pour water on air conditioner. Otherwise, it may cause short circuit or damage to air conditioner.
- Prohibit operating heating equipment around the air conditioner.
- Prohibit operating the unit in the bathroom or laundry room.
- Far away from fire source, inflammable and explosive objects.
- Keep children from playing or climbing on the air conditioner.
- Do not put or hang dripping objects above the air conditioner.
- Do not repair or disassemble the air conditioner by yourself.
- Do not block air outlet or air inlet.
- Prohibit inserting any objects into the air conditioner.
- Do not through sundries into the air duct. If there are sundries get into the air duct, please contact the professionals to deal with it.
- Do not use an extension cord.
- A fuse or circuit breaker should be added at the product circuit. Please refer to the MOP value on the nameplate for the detailed specification.
- The appliance shall be installed in accordance with national wiring regulations.
- If a STATIONARY APPLIANCE is not fitted with a SUPPLY CORD and a plug, an all-pole disconnection switch having a contact separation of at least 3mm in all poles should be connected in fixed wiring.
- There should be no similar ignition source in the air duct.
- Electric heating can't be allowed to be added by yourself.

2 Product Introduction

2.1 Names of Key Components

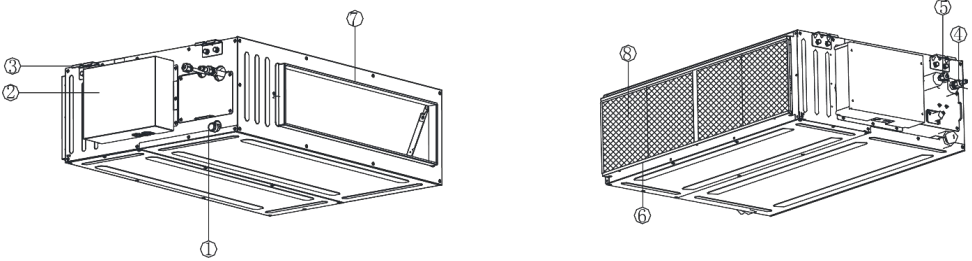

Fig 2.1.1

NO.	1	2	3	4	5	6	7	8
Name	Drain Pipe	Control box	Pothook	Gas pipe	Liquid pipe	Air-return Opening	Air Outlet	Filter

2.2 Rated Working Condition

	Indoor Side Condition		Outdoor Side Condition	
	Dry Bulb Temp °C(°F)	Wet Bulb Temp °C(°F)	Dry Bulb Temp °C(°F)	Wet Bulb Temp °C(°F)
Rated Cooling	26.7(80.0)	19.4(67.0)	35(95.0)	23.9(75.0)
Rated Heating	21.1(70.0)	15.6(60.0)	8.3(47.0)	6.1(43.0)

3 Preparations for Installation

NOTICE!

Product graphics are only for reference. Please refer to actual products. Unspecified measure unit is mm(in.).

3.1 Location for Installation

- (1)The appliance shall not be installed in the laundry.
- (2)The top holder must be strong enough to support unit's weight.
- (3)Drain pipe can drain water out easily.
- (4)There is no obstacle at inlet or outlet. Please ensure good air circulation.
- (5)In order to make sure the space for maintenance, please install the indoor unit according to the dimension described below.
- (6)Keep the unit away from heating source, inflammable gas or smoke.
- (7)This is a concealed ceiling type unit.
- (8)Indoor unit, outdoor unit, power cord and electric wire should stay at least 1m(39-3/8 in.) from the TV set and radio. Otherwise, these electrical appliances may have image interference and noise. (Even if the distance is 1m(39-3/8 in.), when there is strong electric wave, noise may still occur.)

Unit: mm(in.)

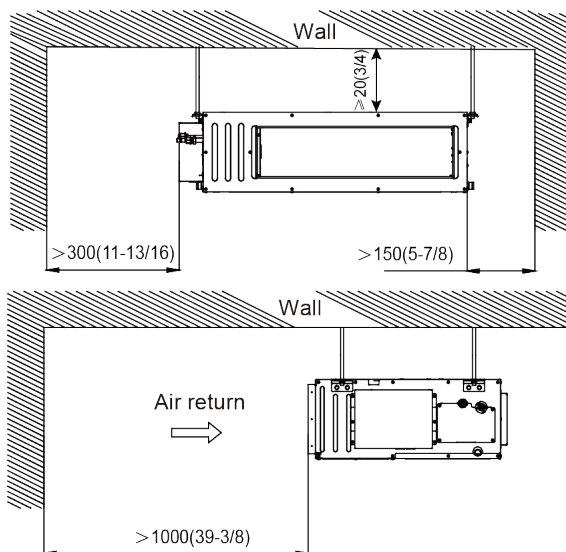

Fig 3.2.1

NOTICE

- (1) Installation of the unit must be in accordance with National Electric Codes and local regulations.
- (2) Improper installation will affect unit's performance, so do not install the unit by yourself. Please contact local dealer to arrange professional technicians for the installation.
- (3) Do not connect power until all installation work is finished.

3.2 Wiring Requirements

(1) Power Cord Size and Fuse Capacity

Model	Power Supply	Fuse Capacity	Min. Power Supply Cord
	V/Ph/Hz	A	
30K	208/230V-1ph-60Hz	5	4xAWG14

NOTICE

- (1) Use copper wire only as unit's power cord. Operating temperature should be within its value.
- (2) If the power cord is more than 15m (49-1/4 ft.) long, please increase properly the sectional area of power cord to avoid overload, which may cause accident.
- (3) Above selection requirements: Power cord size is based on BV single-core wire (2~4pc) at 40°C(104°F) Ambient temperature when laying across plastic pipe. Air switch is D type and used at 40°C(104°F). If actual installation condition varies, please lower the capacity appropriately according to the specifications of power cord and air switch provided by manufacturer.
- (4) Install cut-off device near the unit. The minimum distance between each stage of cut-off device should be 3mm(1/8 in.) (The same for both indoor unit and outdoor unit).

4 Installation Instructions

NOTICE!

These duct type indoor units are limited to be installed for one room.

4.1 Installation of Indoor Unit

4.1.1 Outline Dimension and Installation Spots

Equip with a inspection hatch after lifting the unit. For the convenience of maintenance, the service port should be on one side of the electric box and below unit's lower level.

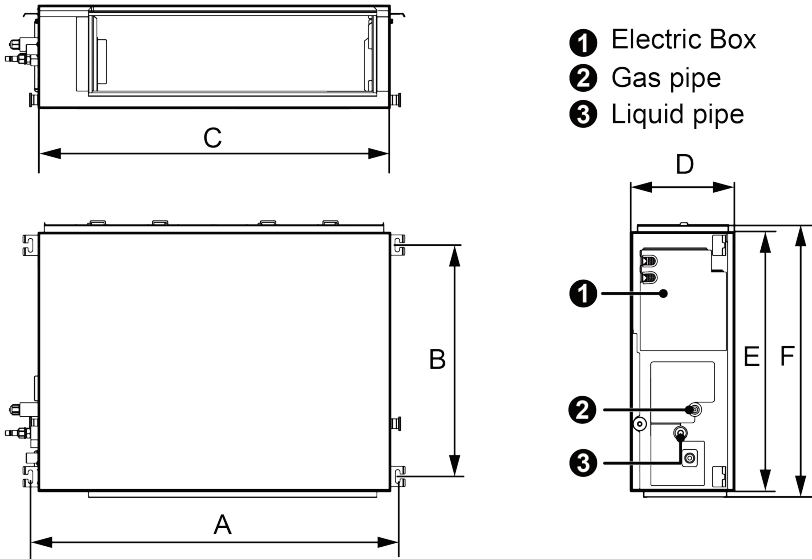

Below are dimensions of A, B, C, etc. for different models:

Unit:mm

Model	A	B	C	D	E	F
30K	37 1/16	23 1/4	35 7/16	10 1/4	25 13/16	27 1/4

4.1.2 Suspend the indoor unit

(1) Drill bolt holes and install bolts

- 1) Stick the reference cardboard on the installation position; drill 4 holes according to the hole site on the cardboard as shown in fig 4.1.3; diameter of drilling hole is according to the diameter of expansion bolt and the depth is 60-70mm(2-3/8~2-3/4 in.), as shown in fig 4.1.4.

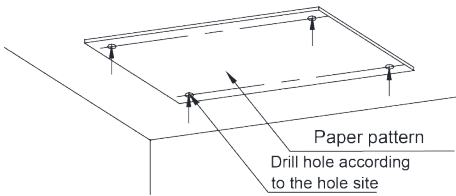

Fig 4.1.3

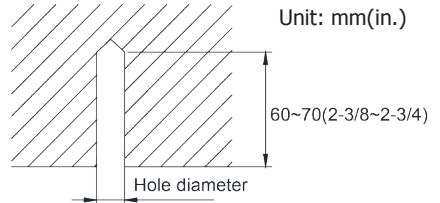

Fig 4.1.4

- 2) Insert the M10 expansion bolt into the hole and then knock the nail into the bolt, as shown in fig 4.1.5, and then remove the paper pattern.

NOTICE!

The length of bolt depends on the installation height of the unit, bolts are field supplied.

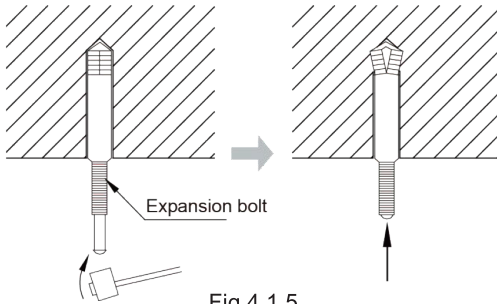

Fig 4.1.5

(2) Install the indoor unit temporarily

Assemble suspension bolt on the expansion bolt, attach the hanger bracket to the suspension bolt. Be sure to fix it securely by using a nut and washer from upper and lower sides of the hanger bracket. The washer fixing plate will prevent the washer from falling.

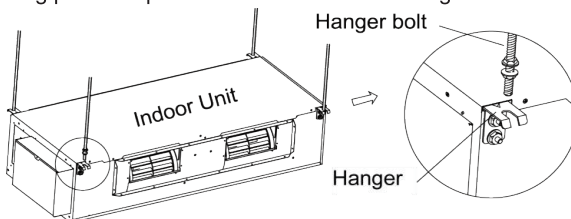

Fig 4.1.6

NOTICE!

- 1) Before operation, please prepare all pipelines (connection pipe, drainage hose) and wires (connection wire for wired controller, connection wire for indoor unit).
- 2) When drilling holes on ceiling (air return outlet or air outlet), you can need to reinforce the ceiling to prevent vibration. For details, please consult user or builder.
- 3) If the strength of the ceiling is not good, please install a beam bracket, and then put the unit on the beam bracket.
- (3) Adjust the unit to the right position.
- (4) Check the level of the unit

After the indoor unit is installed, remember to check the horizontal status of the whole unit. It should be horizontal from front to back and slant 1% from left to right, following the drainage direction.

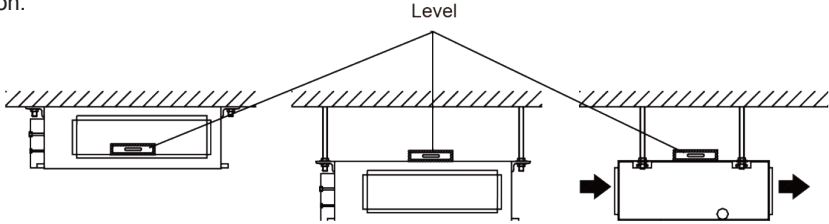
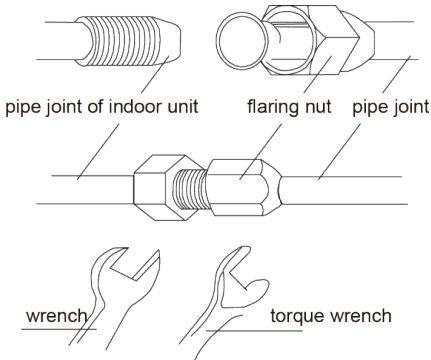

Fig 4.1.8

- (5) Remove the washer locating plate and then tighten the nut on it.

4.2 Refrigerant Pipe Connection

- (1) Aim the flaring port of copper pipe at the center of screwed joint and then tighten the flaring nut with hand as shown in fig 4.2.1.
- (2) Tighten the flaring nut with torque wrench.



Torque for tightening nut

Pipe diameter mm(in.)	Torque(ft-lb)
Φ6.35(1/4)	11-22
Φ9-9.52(3/8)	25-29
Φ12.7(1/2)	33-36
Φ15.9(5/8)	44-47
Φ19.05(3/4)	51-55

Fig 4.2.1

- (3) Use pipe bend when bending the pipe and the bending angle should not be too small.
- (4) Wrap the connection pipe and joint with sponge and then tie them firmly with tape.

4.3 Drainage Pipe Installation and Drainage System Testing

4.3.1 Notice for Installation of Drain Pipe

- (1) The drainage pipe should be short and the gradient downwards should be at least 1%~2% in order to drain condensation water smoothly.
- (2) The diameter of drainage hose should be bigger or equal to the diameter of drainage pipe joint.
- (3) Install drainage pipe according to the following fig and arrange insulation to the drainage pipe (Fig 4.3.1). Improper installation may lead to water leakage and damp the furniture and other things in the room.
- (4) You can buy normal hard PVC pipe used as the drainage pipe. During connection, insert the end of PVC pipe into the drainage hole and then tighten it with drainage hole and wire binder. Can't connect the drainage hole and drainage hole with glue.
- (5) When the drainage pipelines are used for several units, the position of pipeline should be about 100mm(4in.) lower than the drainage port of each unit. In this case, thicker pipes should be applied.

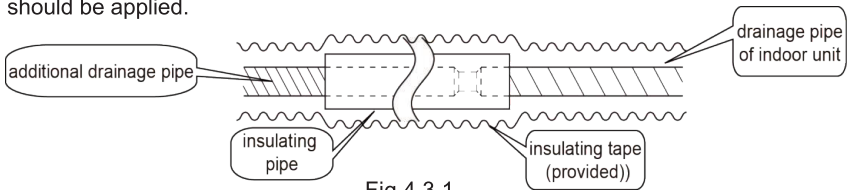

Fig 4.3.1

4.3.2 Drainage pipe installation

- (1) Insert the drain hose into the drain hole and tighten it with tapes, as shown in Fig 4.3.2.
- (2) Tighten the pipe clamp, with the distance between screw nut and hose smaller than 4mm(1/8in.).
 - ① metal clamp(accessory)
 - ② drain hose(accessory)
- (3) Use sealing plate to make the pipe clamp and hose insulated, as shown in Fig.4.3.3.
 - ① metal clamp(accessory)
 - ② thermal sponge(accessory)

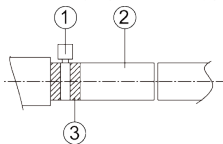

Fig 4.3.2

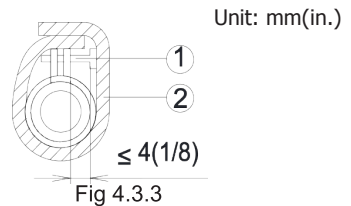
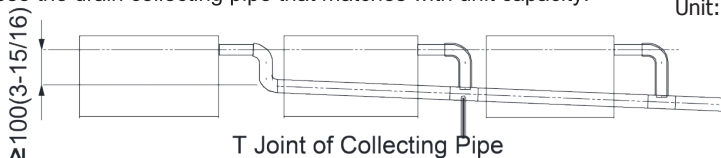

Fig 4.3.3

- (4) When connecting several drain pipes, follow the instruction as indicated in Fig 4.3.4. Choose the drain collecting pipe that matches with unit capacity.



T Joint of Collecting Pipe

Fig 4.3.4

- (5) Install the trap as shown in following Fig 4.3.5.
- (6) Install one trap for each unit.
- (7) Convenience for cleaning trap in the future should be considered when installing it.

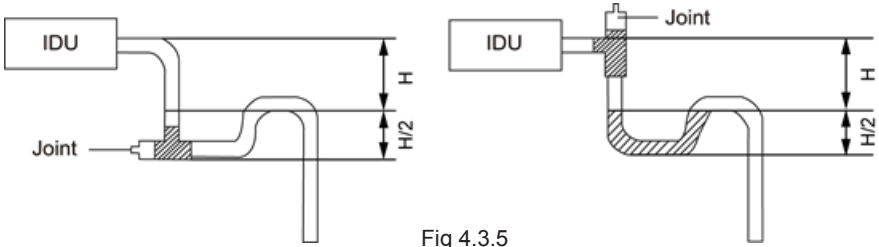

Fig 4.3.5

- (8) The horizontal pipe can be connected to vertical pipe in the same level; please select the connection way as shown in following fig.

NO1: Connection of drainage pipe joints (Fig4.3.6)

NO2: Connection of downspout elbow (Fig4.3.7)

NO3: Inserting pipe connection (Fig4.3.8)

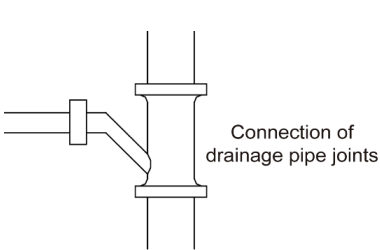

Fig 4.3.6

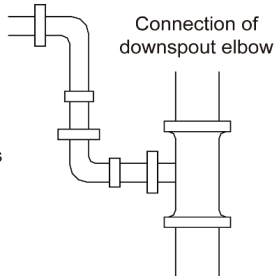

Fig 4.3.7

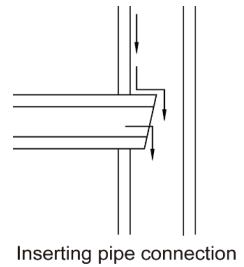

Fig 4.3.8

- (9) The installation height of raising pipe for drainage should be lower than B. The gradient from raising pipe towards drainage direction should be at least 1%~2%. If the raising pipe is vertical with the unit, the raising height should be less than C.

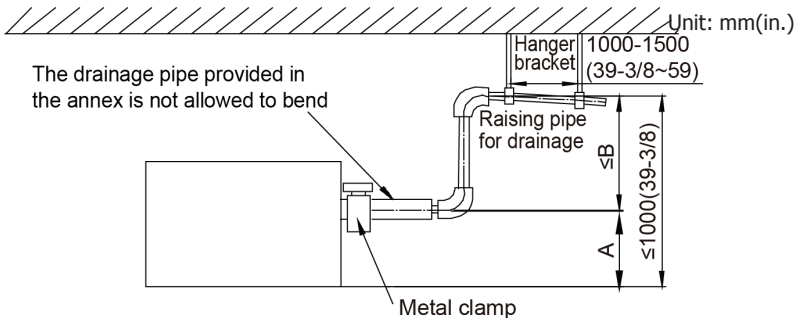

Fig 4.3.9

Model	A	B	C
30K	150 (5-7/8)	850 (33-1/2)	800 (31-1/2)

(10) Drain pipes should have a downward slope of at least 1%~2%, in order to prevent pipes from sagging, install hanger bracket at intervals of 1000~1500mm(39-3/8~59 in.).

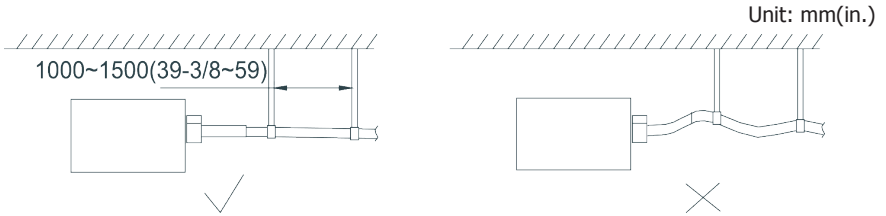

Fig 4.3.10

4.3.3 Test of Drainage System

◆ Models with water pump

(1) Please test drainage system after electric work is finished.

Inject approximately 1L purified water to drain pan from air vent, ensure that not to splash the water over the electrical components (e.g. water pump. etc.).

- 1) Spray 1L water on evaporator with sprayer.
- 2) In case of commissioning finished, please energize the IDUs and switch to cooling or dry mode, meanwhile, the water pump operates, you can check the draining through the transparent part of drain socket.
- 3) If communication wire is not connected, communication malfunction “E6” will occur after 3min of energizing. In this case, the water pump operates automatically. Check if the water pump drains normally through drainage port. The water pump will stop automatically after running for 1min.

(2) During the test, please carefully check the drainage joint, make sure no any leakage occur.

(3) It is strongly recommend to do the drain test before ceiling decoration.

◆ Models without water pump

(1) Inject some water to the water tray of indoor unit as following:

- 1) Connect the drain hose to the other drain connection pipe of water tray and inject approximately 1L water. (Remove the drain hose after finishing testing and then put on the plug of water tray.)
- 2) Spray 1L water on evaporator with sprayer.

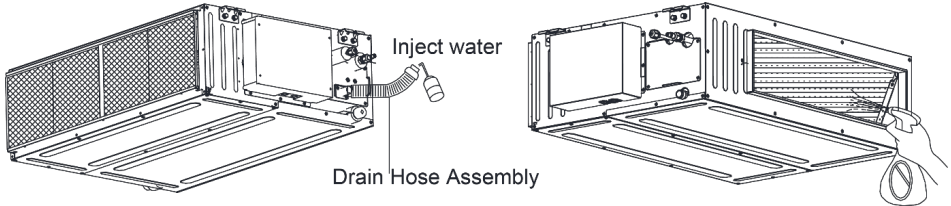

Fig 4.3.11

- (2) Check if the water drains smoothly from the drain pipe and check if there is water leakage on the connection pipe.
- (3) Arrange insulation of drain hose and pipe clamp after checking the drain system.

4.4 Installation of Air Duct

NOTICE!

- ① There should be insulating layer on air-out duct, air-return duct and fresh air duct to avoid heat loss and moisture. Adhere a nail on the air duct and then add thermal sponge with a layer of tin. Fasten it with a nail cover and then seal the junction with tin tapes. You can also use other materials that have good insulation quality.
- ② Each air-out duct and air-return duct should be fixed on a pre-made board with iron frame. The junction of air duct should be well-sealed in order to prevent air leakage.
- ③ The design and construction of air duct should comply with national requirements.
- ④ The edge of air-return duct is suggested to be more than 150mm(5-7/8 in.) away from the wall. Add a filter to the air-return opening.
- ⑤ Please consider noise-damping and vibration damping for the design and construction of air duct. Besides, noise source must be away from people. For instance, do not have the air-return opening installed on top of the user (Offices, rest area, etc.).

4.4.1 Shape and Size of Air Outlet and Air-return Opening

Unit: inch

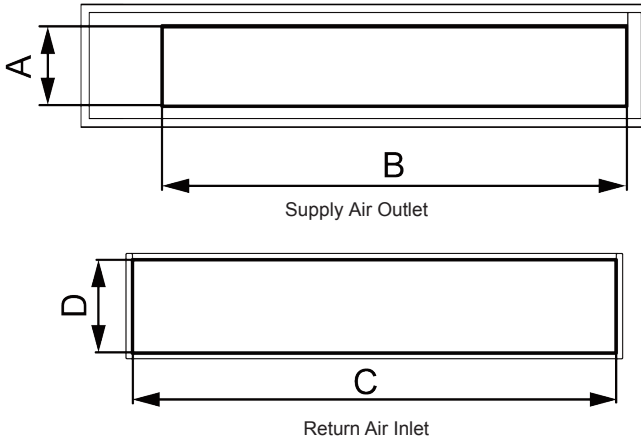

Model	Supply Air Outlet		Return Air Inlet	
	A	B	C	D
30K	8 15/32	29 9/64	34 19/64	9 7/32

4.4.2 Installation of Air-out Duct

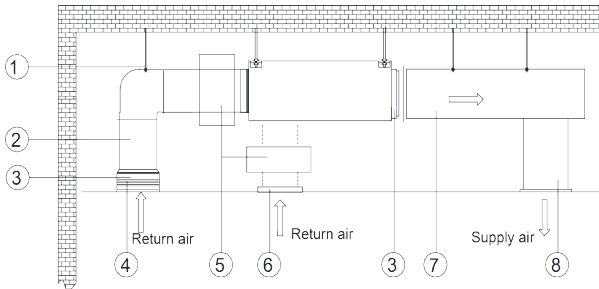

Fig 4.4.5

No.	Name	No.	Name
1	Hanger Rod	5	Static Pressure Box
2	Return Air Duct	6	Filter
3	Canvas Duct	7	Main Supply Air Duct
4	Return Air Inlet	8	Supply Air Outlet

4.4.3 Installation of the Return Air Duct

- (1) The default installation location of the rectangular flange is at the back and the return air cover plate is at the bottom, as shown in Fig 4.4.6.

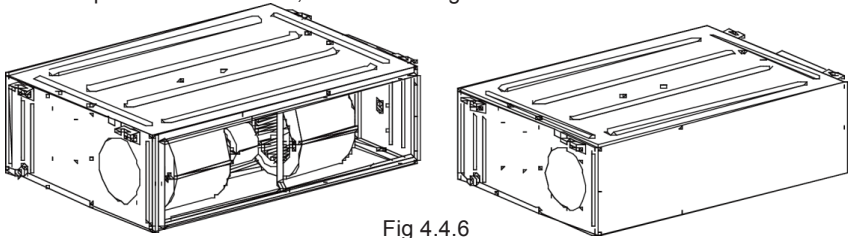

Fig 4.4.6

- (2) If the bottom return air is desired, just change the place of the rectangular flange and the return air cover plate.
- (3) Connect one end of the return air duct to the return air outlet of the unit by rivets and the other to the return air louver. For the sake of the convenience to freely adjust the height, a cutting of canvas duct will be helpful, which can be reinforced and folded by 8# iron wire.
- (4) More noise is likely to be produced in the bottom return air mode than the rear return air mode, so it is suggestive to install a silencer and a static pressure box to minimize the noise.
- (5) The installation method can be chosen with considering the conditions of the building and maintenance etc., as shown in Fig 4.4.7.

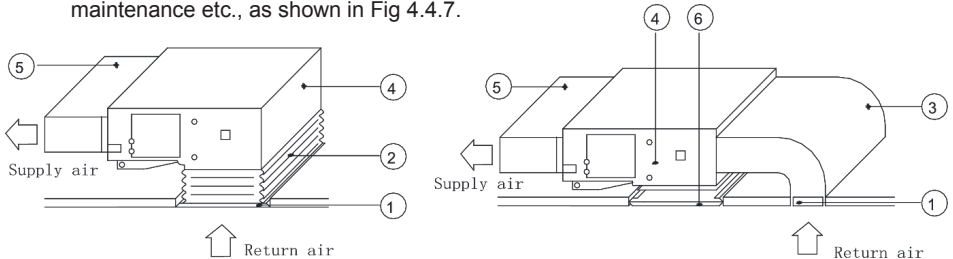

Fig 4.4.7

Table 5 Installation of the return air duct

No.	Name	No.	Name
1	Return Air Inlet (with filter)	4	Indoor unit
2	Canvas Duct	5	Supply Air Duct
3	Return Air Duct	6	Grille

4.4.4 Installation of the Fresh Air Pipe

- (1) When the fresh air pipe is needed to be connected, cut the fresh air baffle as Fig 4.4.8. Plug up the gap of the fresh air baffle by sponge if the fresh air duct is not be used.
- (2) Install the round flange so that the fresh air duct can be connected as Fig 4.4.9.
- (3) Sealing and heat preservation should be done for both the air pipe and round flange pipe.
- (4) Fresh air should be treated via the air filter.

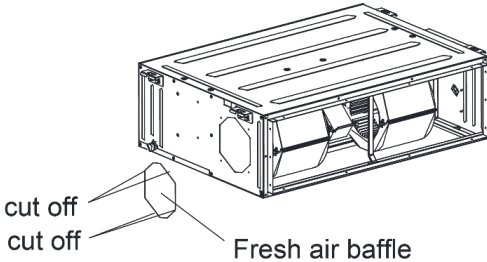

Fig 4.4.8

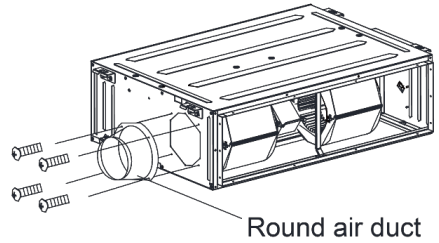

Fig 4.4.9

4.5 Installation of Wired Controller

Please refer to User Manual of Wired Controller for the installation details.

NOTICE! When installation is finished, the unit must be tested and debugged before operation. Please refer to Instruction Manual of ODU for auto addressing and debugging details.

5 Wiring Work

▲WARNING

Before obtaining access to terminals, all supply circuits must be disconnected.

NOTICE

- | |
|--|
| (1) Units must be earthed securely, or it may cause electric shock. |
| (2) Please carefully read the wiring diagram before carry out the wiring work, incorrect wiring could cause malfunction or even damage the unit. |
| (3) The unit should be powered by independent circuit and specific socket. |
| (4) The wiring should be in accordance with related regulations in order to ensure the units reliable running. |
| (5) Install circuit breaker for branch circuit according to related regulations and electrical standards. |
| (6) Keep cable away from refrigerant pipings, compressor and fan motor. |
| (7) The communication wires should be separated from power cord and connection wire between indoor unit |
| (8) Adjust the static pressure via wired controller according to site circumstance. |

5.1 Connection of Wire and Patch Board Terminal

- (1) The connection of wire (as shown in fig 5.1.1)
 - 1) Strip about 25mm(1 in.) insulation of the wire end by stripping and cutting tool.
 - 2) Remove the wiring screws on the terminal board.
 - 3) Shape the tail of wire into ring by needle nose plier, and keep the gauge of ring in accordance with screw.
 - 4) Use the screwdriver for tightening the terminal.

(2) The connection of stranded wire (as shown in fig 5.1.2)

- 1) Strip about 10mm (3/8 in.) insulation of the end of stranded wire by stripping and cutting tool.
- 2) Loosen the wiring screws on terminal board.
- 3) Insert the wire into the ring tongue terminal and tighten by crimping tool.
- 4) Use the screwdriver for tightening the terminal.

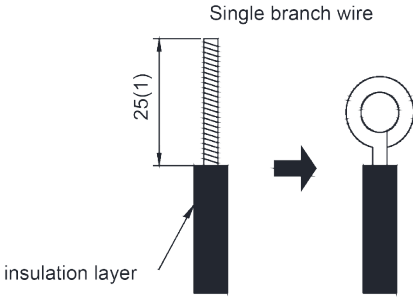

Fig 5.1.1

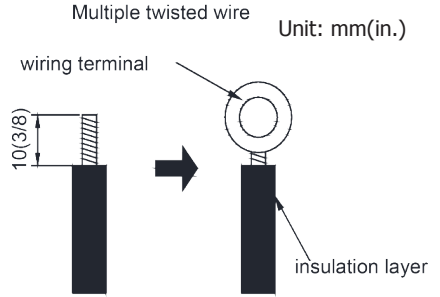

Fig 5.1.2

5.2 Power Cord Connection

NOTICE!

- ① Every unit should be equipped with a circuit breaker for short-circuit and overload protection.
- ② During operation, all indoor units connected to the same outdoor unit system must be kept energized status. Otherwise, the unit can't operate normally.

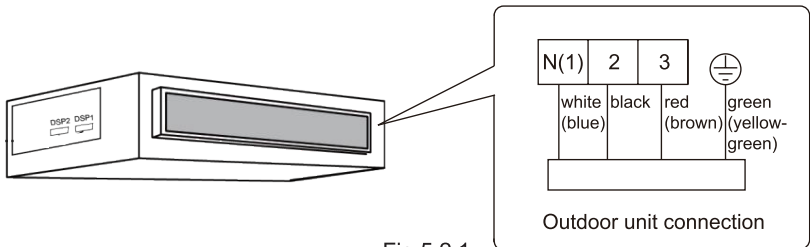

Fig 5.2.1

NOTICE!

Indoor unit quantity n is according to the outdoor unit capacity.

- For units with single-phase power supply.
 - (1) Detach the electric box lid.
 - (2) Let the power cord pass through the wiring through-holes.
 - (3) Fix the power card with wiring clamp.
 - (4) The wire diameter of power cord can't be less than 18AWG.

5.3 Wiring of the Signal Line of the Wired Controller

- (1) Open the cover of the electric box of the indoor unit.
- (2) Let the signal line go through the rubber ring.
- (3) Insert the signal line to the four-pin socket on the printed circuit board of the indoor unit.
- (4) Fix the signal line with the binding wire.

6 Setting of External Static Pressure

Working range for external static pressure of this series of duct type unit is 0 Pa~275 Pa. For corresponding external static pressure to the respective static pressure notch please see as below. The setting of static pressure for indoor fan can be done via wired controller and our debugging software. For specific setting method please see the Wired Controller Instruction Manual or Our Debugging Software Instruction Manual.

Applicable to: 30K								
Static pressure notch for indoor fan	2	3	4	5	6	7	8	9
External static pressure (Pa)	10	15	25	37	50	75	100	160

7 Routine Maintenance

7.1 Maintenance before the Seasonal Use

- (1) Check if the air inlet and air outlet of indoor and outdoor unit are blocked.
- (2) Check if securely grounded.
- (3) Check if all the power cord and communication cable are securely connected.
- (4) Check if any error code displayed after energized.

7.2 Maintenance after the Seasonal Use

- (1) Set the unit in fan mode for half a day in a sunny day to dry the inner part of unit;
- (2) When the unit won't be used for a long time, please cut off power supply for energy saving; the characters on the wired controller screen will disappear after cutting off the power supply.

8 Table of Error Codes for Indoor Unit

Number	Error code	Error
1	E1	Compressor high pressure protection
2	E2	Indoor anti-freeze protection
3	E3	Compressor low pressure protection, refrigerant lack protection and refrigerant colleting mode
4	E4	Compressor high discharge temperature protection
5	E5	AC over-current protection
6	E6	Communication error
7	E7	Mode conflict
8	E8	Anti-high temperature protection
9	E9	Full water protection
10	F1	Indoor ambient temperature sensor is open/short circuited
11	F2	Indoor evaporator temperature sensor is open/short circuited
12	F3	Outdoor ambient temperature sensor is open/short circuited
13	F4	Outdoor condenser temperature sensor is open/short circuited
14	F5	Outdoor discharge temperature sensor is open/short circuited
15	H6	No feedback of indoor fan motor
16	U8	Zero-crossing protection
17	C5	Jumper cap malfunction protection
18	EE	Loading EEPROM malfunction
19	EA	Refrigerant leakage alarm

Note: If there're other error codes, please contact qualified professionals for service.

9 Troubleshooting

The air conditioner is not expected to be serviced by users. Incorrect repair may cause electric shock or fire, so please contact an authorized service center for professional service. The following checks prior to contact may save your time and money.

Phenomenon	Troubleshooting
The unit can't start	① Power supply is not connected. ② Circuit breaker tripping caused by leakage of electricity. ③ Input voltage is too low. ④ Defect of main PC-board.
The unit stops after running for a while.	① The inlet or outlet of ODU or IDU are blocked by obstacle.
Poor cooling effect	① The filter is dirty. ② Too heavy heat load of room(e.g. too many people) ③ Door or windows is open. ④ Inlet and outlet of IDU are blocked. ⑤ Setting temperature is too high. ⑥ Refrigerant is insufficient (e.g. refrigerant leakage)
Poor heating effect	① The filter is dirty. ② Door or window is open. ③ Setting temperature is too low. ④ Refrigerant is insufficient (e.g. refrigerant leakage)
Indoor fan doesn't start up during heating	① At starting, the IDU fan could not operate till the heat exchange become hot, for preventing delivering the cool air. ② At defrosting, the IDU fan stopped due to system switch to cooling mode. for preventing delivering the cool air, and resume operating after defrosting.

NOTICE!

If air conditioner still fails to work normally after checking and handling as described above, please stop using it immediately and contact local service center for assistance.

10 SPECIALIST'S MANUAL

Aptitude requirement for maintenance man(repairs should be done only be specialists).

- a. Any person who is involved with working on or breaking into a refrigerant circuit should hold a current valid certificate from an industry-accredited assessment authority, which authorises their competence to handle refrigerants safely in accordance with an industry recognised assessment specification.
- b. Servicing shall only be performed as recommended by the equipment manufacturer. Maintenance and repair requiring the assistance of other skilled personnel shall be carried out under the supervision of the person competent in the use of flammable refrigerants.

That pipe-work including piping material, pipe routing, and installation shall include protection from physical damage in operation and service, and be in compliance with national and local codes and standards, such as ASHRAE 15, ASHRAE 15.2, IAPMO Uniform Mechanical Code, ICC International Mechanical Code, or CSA B52. All field joints shall be accessible for inspection prior to being covered or enclosed.

- **Checks to the area**

Prior to beginning work on systems containing flammable refrigerants, safety checks are necessary to ensure that the risk of ignition is minimised. For repair to the refrigerating system, the following precautions shall be complied with prior to conducting work on the system.

- **Work procedure**

Work shall be undertaken under a controlled procedure so as to minimise the risk of a flammable gas or vapour being present while the work is being performed.

- **General work area**

All maintenance staff and others working in the local area shall be instructed on the nature of work being carried out. Work in confined spaces shall be avoided.

- **Checking for presence of refrigerant**

The area shall be checked with an appropriate refrigerant detector prior to and during work, to ensure the technician is aware of potentially toxic or flammable atmospheres. Ensure that the leak detection equipment being used is suitable for use with all applicable refrigerants, i.e. non-sparking adequately sealed or intrinsically safe.

- **Presence of fire extinguisher**

If any hot work is to be conducted on the refrigerating equipment or any associated parts, appropriate fire extinguishing equipment shall be available to hand. Have a dry powder or CO2 fire extinguisher adjacent to the charging area.

- **No ignition sources**

No person carrying out work in relation to a refrigerating system which involves exposing any pipe work shall use any sources of ignition in such a manner that it may lead to the risk of fire or explosion. All possible ignition sources, including cigarette smoking, should be kept sufficiently far away from the site of installation, repairing, removing and disposal, during which refrigerant can possibly be released to the surrounding space. Prior to work taking place, the area around the equipment is to be surveyed to make sure that there are no flammable hazards or ignition risks. "No Smoking" signs shall be displayed.

- **Ventilated area**

Ensure that the area is in the open or that it is adequately ventilated before breaking into the system or conducting any hot work. A degree of ventilation shall continue during the period that the work is carried out. The ventilation should safely disperse any released refrigerant and preferably expel it externally into the atmosphere.

- **Checks to the refrigerating equipment**

Where electrical components are being changed, they shall be fit for the purpose and to the correct specification. At all times the manufacturer's maintenance and service guidelines shall be followed. If in doubt, consult the manufacturer's technical department for assistance.

The following checks shall be applied to installations using flammable refrigerants:

- the actual refrigerant charge is in accordance with the room size within which the refrigerant containing parts are installed;
- the ventilation machinery and outlets are operating adequately and are not obstructed;
- if an indirect refrigerating circuit is being used, the secondary circuit shall be checked for the presence of refrigerant;
- marking to the equipment continues to be visible and legible. Markings and signs that are illegible shall be corrected;
- refrigerating pipe or components are installed in a position where they are unlikely to be exposed to any substance which may corrode refrigerant containing components, unless the components are constructed of materials which are inherently

resistant to being corroded or are suitably protected against being so corroded.

- **Checks to electrical devices**

Repair and maintenance to electrical components shall include initial safety checks and component inspection procedures. If a fault exists that could compromise safety, then no electrical supply shall be connected to the circuit until it is satisfactorily dealt with. If the fault cannot be corrected immediately but it is necessary to continue operation, an adequate temporary solution shall be used. This shall be reported to the owner of the equipment so all parties are advised.

Initial safety checks shall include:

- that capacitors are discharged: this shall be done in a safe manner to avoid possibility of sparking;
 - that no live electrical components and wiring are exposed while charging, recovering or purging the system;
 - that there is continuity of earth bonding.
- **Repairs to sealed components**
Sealed electrical components shall be replaced.
 - **Repair to intrinsically safe components**
Intrinsically safe components must be replaced.
 - **Cabling**
Check that cabling will not be subject to wear, corrosion, excessive pressure, vibration, sharp edges or any other adverse environmental effects. The check shall also take into account the effects of aging or continual vibration from sources such as compressors or fans.
 - **Detection of flammable refrigerants**

Under no circumstances shall potential sources of ignition be used in the searching for or detection of refrigerant leaks. A halide torch (or any other detector using a naked flame) shall not be used.

The following leak detection methods are deemed acceptable for all refrigerant systems.

Electronic leak detectors may be used to detect refrigerant leaks but, in the case of flammable refrigerants, the sensitivity may not be adequate, or may need re-calibration. (Detection equipment shall be calibrated in a refrigerant-free area.)

Ensure that the detector is not a potential source of ignition and is suitable for the refrigerant used. Leak detection equipment shall be set at a percentage of the LFL of the refrigerant and shall be calibrated to the refrigerant employed, and the appropriate percentage of gas (25% maximum) is confirmed.

Leak detection fluids are also suitable for use with

most refrigerants but the use of detergents containing chlorine shall be avoided as the chlorine may react with the refrigerant and corrode the copper pipe-work.

NOTE: Examples of leak detection fluids are

- bubble method,
- fluorescent method agents.

If a leak is suspected, all naked flames shall be removed/extinguished.

If a leakage of refrigerant is found which requires brazing, all of the refrigerant shall be recovered from the system, or isolated (by means of shut off valves) in a part of the system remote from the leak. Removal of refrigerant shall be according to clause Removal and evacuation.

- **Removal and evacuation**

When breaking into the refrigerant circuit to make repairs – or for any other purpose – conventional procedures shall be used. However, for flammable refrigerants it is important that best practice be followed, since flammability is a consideration. The following procedure shall be adhered to:

- safely remove refrigerant following local and national regulations;
 - evacuate;
 - purge the circuit with inert gas (optional for A2L);
 - evacuate (optional for A2L);
 - continuously flush or purge with inert gas when using flame to open circuit; and
 - open the circuit.

The refrigerant charge shall be recovered into the correct recovery cylinders if venting is not allowed by local and national codes. For appliances containing flammable refrigerants, the system shall be purged with oxygen-free nitrogen to render the appliance safe for flammable refrigerants. This process might need to be repeated several times. Compressed air or oxygen shall not be used for purging refrigerant systems.

For appliances containing flammable refrigerants, refrigerants purging shall be achieved by breaking the vacuum in the system with oxygen-free nitrogen and continuing to fill until the working pressure is achieved, then venting to atmosphere, and finally pulling down to a vacuum (optional for A2L). This process shall be repeated until no refrigerant is within the system (optional for A2L). When the final oxygen-free nitrogen charge is used, the system shall be vented down to atmospheric pressure to enable work to take place.

The outlet for the vacuum pump shall not be close to any potential ignition sources, and ventilation shall be available.

• **Charging procedures**

In addition to conventional charging procedures, the following requirements shall be followed.

– Ensure that contamination of different refrigerants does not occur when using charging equipment. Hoses or lines shall be as short as possible to minimise the amount of refrigerant contained in them.

– Cylinders shall be kept in an appropriate position according to the instructions.

– Ensure that the refrigerating system is earthed prior to charging the system with refrigerant.

– Label the system when charging is complete (if not already).

– Extreme care shall be taken not to overfill the refrigerating system.

Prior to recharging the system, it shall be pressure-tested with the appropriate purging gas. The system shall be leak-tested on completion of charging but prior to commissioning. A follow up leak test shall be carried out prior to leaving the site.

• **Decommissioning**

Before carrying out this procedure, it is essential that the technician is completely familiar with the equipment and all its detail. It is recommended good practice that all refrigerants are recovered safely. Prior to the task being carried out, an oil and refrigerant sample shall be taken in case analysis is required prior to re-use of recovered refrigerant. It is essential that electrical power is available before the task is commenced.

a) Become familiar with the equipment and its operation.

b) Isolate system electrically.

c) Before attempting the procedure, ensure that:

- mechanical handling equipment is available, if required, for handling refrigerant cylinders;
- all personal protective equipment is available and being used correctly;
- the recovery process is supervised at all times by a competent person;
- recovery equipment and cylinders conform to the appropriate standards.

d) Pump down refrigerant system, if possible.

e) If a vacuum is not possible, make a manifold so that refrigerant can be removed from various parts of the system.

f) Make sure that cylinder is situated on the scales before recovery takes place.

g) Start the recovery machine and operate in accordance with instructions.

h) Do not overfill cylinders. (No more than 80% volume liquid charge).

i) Do not exceed the maximum working pressure of the cylinder, even temporarily.

j) When the cylinders have been filled correctly and the process completed, make sure that the cylinders and the equipment are removed from site promptly and all isolation valves on the equipment are closed off.

k) Recovered refrigerant shall not be charged into another refrigerating system unless it has been cleaned and checked.

• **Labelling**

Equipment shall be labelled stating that it has been de-commissioned and emptied of refrigerant. The label shall be dated and signed. For appliances containing flammable refrigerants, ensure that there are labels on the equipment stating the equipment contains flammable refrigerant.

• **Recovery**

When removing refrigerant from a system, either for servicing or decommissioning, it is recommended good practice that all refrigerants are removed safely.

When transferring refrigerant into cylinders, ensure that only appropriate refrigerant recovery cylinders are employed. Ensure that the correct number of cylinders for holding the total system charge are available. All cylinders to be used are designated for the recovered refrigerant and labelled for that refrigerant (i.e. special cylinders for the recovery of refrigerant). Cylinders shall be complete with pressure-relief valve and associated shut-off valves in good working order. Empty recovery cylinders are evacuated and, if possible, cooled before recovery occurs.

The recovery equipment shall be in good working order with a set of instructions concerning the equipment that is at hand and shall be suitable for the recovery of the flammable refrigerant. If in doubt, the manufacturer should be consulted. In addition, a set of calibrated weighing scales shall be available and in good working order. Hoses shall be complete with leak-free disconnect couplings and in good condition.

The recovered refrigerant shall be processed according to local legislation in the correct recovery cylinder, and the relevant waste transfer note arranged. Do not mix refrigerants in recovery units and especially not in cylinders.

If compressors or compressor oils are to be removed, ensure that they have been evacuated

to an acceptable level to make certain that flammable refrigerant does not remain within the lubricant. The compressor body shall not be heated by an open flame or other ignition sources to accelerate this process. When oil is drained from a system, it shall be carried out safely.

Transportation, marking and storage for units
Transport of equipment containing flammable refrigerants.

Attention is drawn to the fact that additional transportation regulations may exist with respect to equipment containing flammable gas. The maximum number of pieces of equipment or the configuration of the equipment permitted to be transported together will be determined by the applicable transport regulations.

Marking of equipment using signs

Signs for similar appliances used in a work area are generally addressed by local regulations and give the minimum requirements for the provision of safety and/or health signs for a work location.

All required signs are to be maintained and employers should ensure that employees receive suitable and sufficient instruction and training on the meaning of appropriate safety signs and the actions that need to be taken in connection with these signs.

The effectiveness of signs should not be diminished by too many signs being placed together.

Any pictograms used should be as simple as possible and contain only essential details.

Disposal of equipment using flammable refrigerants

See national regulations.

Storage of equipment/appliances

The storage of the appliance should be in accordance with the applicable regulations or instructions, whichever is more stringent.

Avoid other heat sources or direct sun light.

Avoid a place where is possible for inflammable gas to leak out.

Storage of packed (unsold) equipment

Storage package protection should be constructed such a way that mechanical damage to the equipment inside the package will not cause a leak of the REFRIGERANT CHARGE.

The maximum number of pieces of equipment permitted to be stored together will be determined by local regulations.

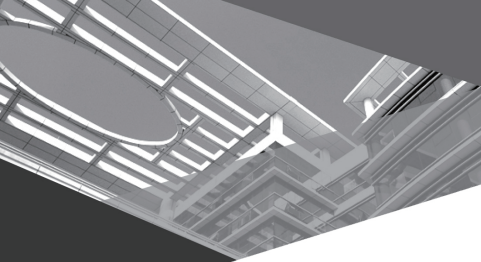

GREE ELECTRIC APPLIANCES, INC. OF ZHUHAI

Add: West Jinji Rd, Qianshan, Zhuhai, Guangdong, China, 519070

Tel: (+86-756) 8522218

Fax: (+86-756) 8669426

E-mail: global@cn.gree.com

Web: www.gree.com



600005068613