



ALL-MATCH INVERTER SERIES_R32

Service Manual

OWC09HP230V1R32AH

OWC12HP230V1R32AH

OWC18HP230V1R32AH

OWC20HP230V1R32AH

GREE ELECTRIC APPLIANCES, INC. OF ZHUHAI

Table of Contents

Part I : Technical Information	1
1. Summary.....	1
2. Specifications.....	2
3. Outline Dimension Diagram.....	6
4. Refrigerant System Diagram	7
5. Electrical Part	8
5.1 Wiring Diagram	8
5.2 PCB Printed Diagram.....	10
6. Function and Control	11
6.1 Remote Controller Introduction for YBE1FB5F.....	11
6.2 Wired Controller Introduction for XE72-44/E.....	17
6.3 Brief Description of Models and Functions.....	35
Part II : Installation and Maintenance	37
7. Notes for Installation and Maintenance.....	37
8. Installation	45
8.1 Names of Key Components.....	45
8.2 Rated Working Condition	45
8.3 Preparative for Installation	46
8.4 Installation Instructions	46
9. Maintenance	53
9.1 Error Code List.....	53
9.2 Procedure of Troubleshooting	54
9.3 Troubleshooting for Normal Malfunction	60

10. Exploded View and Parts List..... 62

11. Removal Procedure 64

Appendix 67

 Appendix 1: Reference Sheet of Celsius and Fahrenheit.....67

 Appendix 2: Pipe Expanding Method.....68

 Appendix 3: List of Resistance for Temperature Sensor.....69

1. Summary

Indoor Unit:

OWC09HP230V1R32AH OWC12HP230V1R32AH
 OWC18HP230V1R32AH OWC20HP230V1R32AH



Remote Controller:

YBE1FB5F



Wired Controller:

XE72-44/E

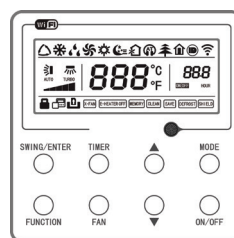

Model list:

No.	Model	Product code	Indoor model	Indoor product code	Panel model	Panel product code	Remote Controller	Wired Controller
1	OWC09HP230V1R32AH	CN51000511	OWC09HP230V1R32AH	CN510N0510	TD01	TL10000011	YBE1FB5F	XE72-44/E
2	OWC12HP230V1R32AH	CN51000521	OWC12HP230V1R32AH	CN510N0520				
3	OWC18HP230V1R32AH	CN51000531	OWC18HP230V1R32AH	CN510N0530				
4	OWC20HP230V1R32AH	CN51000541	OWC20HP230V1R32AH	CN510N0540				

2. Specifications

Model	-	OWC09HP230V1R32AH
Product Code	-	CN510N0510
Power Supply	Rated Voltage	V~ 208/230
	Rated Frequency	Hz 60
	Phases	- 1
Cooling Capacity	Btu/h	9100
Heating Capacity	Btu/h	10500
Air Flow Volume	CFM	324/265/265/230/230/200/200
Dehumidifying Volume	Pint/h	1.69
Fan Type	-	Cross-flow
Fan Diameter-Height	mm	Φ107-778
Fan Motor Cooling Speed	rpm	1000/900/900/820/820/750/750
Fan Motor Heating Speed	rpm	1000/900/900/820/820/750/750
Fan Motor Power Output	W	30
Fan Motor Power Input	W	/
Fan Motor Running Current	A	0.2
Fan Motor Capacitor	μF	/
Evaporator Material	-	Aluminum fin-copper tube
Evaporator Pipe Diameter	mm	Φ7
Evaporator Number of Rows-Fin Pitch	mm	2-1.6
Evaporator Length(L)×Height(H)×Width(W)	mm	790×114.3×25.4 + 790×114.3×25.4
Fuse Current	A	5
Sound Pressure Level	dB (A)	37/35/35/32/32/31/31
Sound Power Level	dB (A)	47/45/45/42/42/41/41
Panel Outline Dimension(W×D×H)	inch	47 1/4 × 18 7/64 × 2 11/64
Dimension of Outline(L×D×H)	inch	38 55/64 × 15 5/32 × 7 1/64
Dimension of Carton Box(L×W×H)	inch	51 11/32 × 19 39/64 × 11 39/64
Dimension of Package(L×W×H)	inch	51 29/64 × 19 23/32 × 12 13/64
Net Weight	lb	42.99
Gross Weight	lb	58.42
Liquid Pipe	inch	1/4
Gas Pipe (to indoor unit)	inch	3/8

The above data is subject to change without notice. Please refer to the nameplate of the unit.

2. Specifications

Model		-	OWC12HP230V1R32AH
Product Code		-	CN510N0520
Power Supply	Rated Voltage	V~	208/230
	Rated Frequency	Hz	60
	Phases	-	1
Cooling Capacity		Btu/h	12000
Heating Capacity		Btu/h	12000
Air Flow Volume		CFM	353/294/294/259/259/230/230
Dehumidifying Volume		Pint/h	2.96
Fan Type		-	Cross-flow
Fan Diameter-Height		mm	Φ107-778
Fan Motor Cooling Speed		rpm	1150/1000/1000/850/850/770/770
Fan Motor Heating Speed		rpm	1150/1000/1000/850/850/770/770
Fan Motor Power Output		W	30
Fan Motor Power Input		W	/
Fan Motor Running Current		A	0.2
Fan Motor Capacitor		μF	/
Evaporator Material		-	Aluminum fin-copper tube
Evaporator Pipe Diameter		mm	Φ7
Evaporator Number of Rows-Fin Pitch		mm	2-1.6
Evaporator Length(L)×Height(H)×Width(W)		mm	790×114.3×25.4 + 790×114.3×25.4
Fuse Current		A	5
Sound Pressure Level		dB (A)	41/37/37/35/35/34/34
Sound Power Level		dB (A)	51/47/47/45/45/44/44
Panel Outline Dimension(W×D×H)		inch	47 1/4 × 18 7/64 × 2 11/64
Dimension of Outline(L×D×H)		inch	38 55/64 × 15 5/32 × 7 1/64
Dimension of Carton Box(L×W×H)		inch	51 11/32 × 19 39/64 × 11 39/64
Dimension of Package(L×W×H)		inch	51 29/64 × 19 23/32 × 12 13/64
Net Weight		lb	42.99
Gross Weight		lb	58.42
Liquid Pipe		inch	1/4
Gas Pipe (to indoor unit)		inch	3/8

The above data is subject to change without notice. Please refer to the nameplate of the unit.

2. Specifications

Model		-	OWC18HP230V1R32AH
Product Code		-	CN510N0530
Power Supply	Rated Voltage	V~	208/230
	Rated Frequency	Hz	60
	Phases	-	1
Cooling Capacity		Btu/h	18000
Heating Capacity		Btu/h	18000
Air Flow Volume		CFM	412/353/353/294/294/265/265
Dehumidifying Volume		Pint/h	3.80
Fan Type		-	Cross-flow
Fan Diameter-Height		mm	Φ107-778
Fan Motor Cooling Speed		rpm	1250/1100/1100/900/900/850/850
Fan Motor Heating Speed		rpm	1250/1100/1100/900/900/850/850
Fan Motor Power Output		W	30
Fan Motor Power Input		W	/
Fan Motor Running Current		A	0.3
Fan Motor Capacitor		μF	/
Evaporator Material		-	Aluminum fin-copper tube
Evaporator Pipe Diameter		mm	Φ7
Evaporator Number of Rows-Fin Pitch		mm	2/3-1.6
Evaporator Length(L)×Height(H)×Width(W)		mm	790×114.3×25.4 + 790×114.3×38.1
Fuse Current		A	5
Sound Pressure Level		dB (A)	43/39/39/36/36/35/35
Sound Power Level		dB (A)	53/49/49/46/46/45/45
Panel Outline Dimension(W×D×H)		inch	47 1/4 × 18 7/64 × 2 11/64
Dimension of Outline(L×D×H)		inch	38 55/64 × 15 5/32 × 7 1/64
Dimension of Carton Box(L×W×H)		inch	51 11/32 × 19 39/64 × 11 39/64
Dimension of Package(L×W×H)		inch	51 29/64 × 19 23/32 × 12 13/64
Net Weight		lb	44.1
Gross Weight		lb	59.535
Liquid Pipe		inch	1/4
Gas Pipe (to indoor unit)		inch	1/2

The above data is subject to change without notice. Please refer to the nameplate of the unit.

2. Specifications

Model	-	OWC20HP230V1R32AH
Product Code	-	CN510N0540
Power Supply	Rated Voltage	V~ 208/230
	Rated Frequency	Hz 60
	Phases	- 1
Cooling Capacity	Btu/h	19000
Heating Capacity	Btu/h	19500
Air Flow Volume	CFM	441/383/383/324/324/294/294
Dehumidifying Volume	Pint/h	4.23
Fan Type	-	Cross-flow
Fan Diameter-Height	mm	Φ107-778
Fan Motor Cooling Speed	rpm	1330/1180/1180/1030/1030/900/900
Fan Motor Heating Speed	rpm	1330/1180/1180/1030/1030/900/900
Fan Motor Power Output	W	30
Fan Motor Power Input	W	/
Fan Motor Running Current	A	0.3
Fan Motor Capacitor	μF	/
Evaporator Material	-	Aluminum fin-copper tube
Evaporator Pipe Diameter	mm	Φ7
Evaporator Number of Rows-Fin Pitch	mm	2-1.6
Evaporator Length(L)×Height(H)×Width(W)	mm	790×114.3×25.4 + 790×114.3×38.1
Fuse Current	A	5
Sound Pressure Level	dB (A)	46/43/43/40/40/36/36
Sound Power Level	dB (A)	56/53/53/50/50/46/46
Panel Outline Dimension(W×D×H)	inch	47 1/4 × 18 7/64 × 2 11/64
Dimension of Outline(L×D×H)	inch	38 55/64 × 15 5/32 × 7 1/64
Dimension of Carton Box(L×W×H)	inch	51 11/32 × 19 39/64 × 11 39/64
Dimension of Package(L×W×H)	inch	51 29/64 × 19 23/32 × 12 13/64
Net Weight	lb	44.1
Gross Weight	lb	59.535
Liquid Pipe	inch	1/4
Gas Pipe (to indoor unit)	inch	1/2

The above data is subject to change without notice. Please refer to the nameplate of the unit.

3. Outline Dimension Diagram

09K, 12K, 18K, 20K

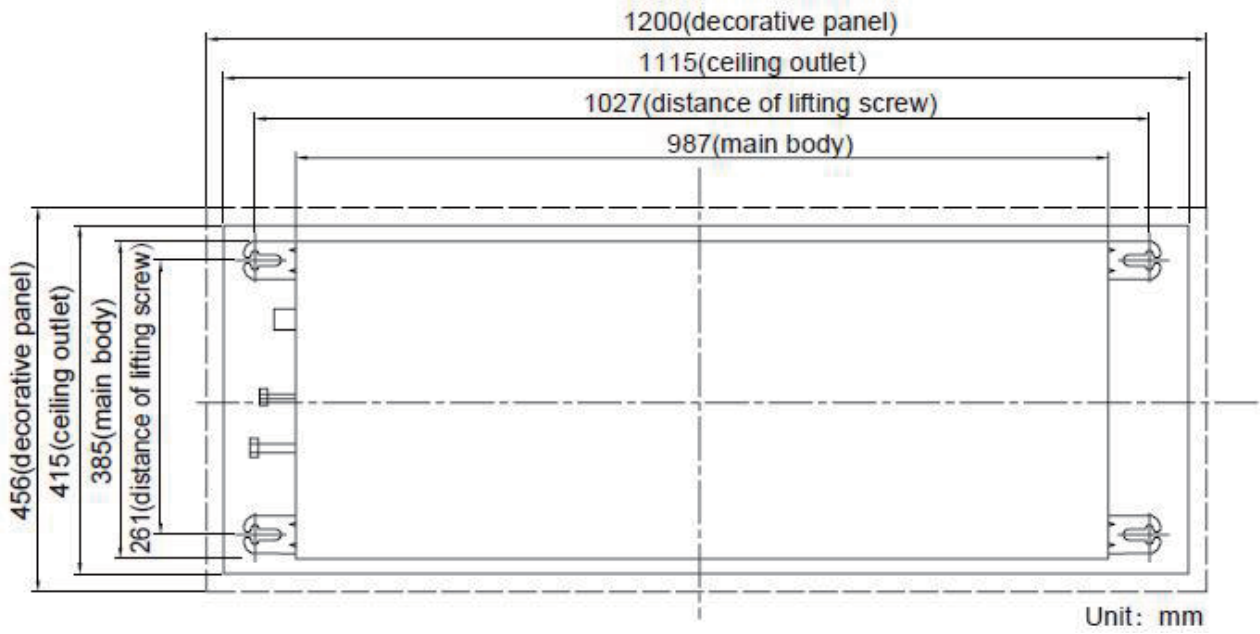

4. Refrigerant System Diagram

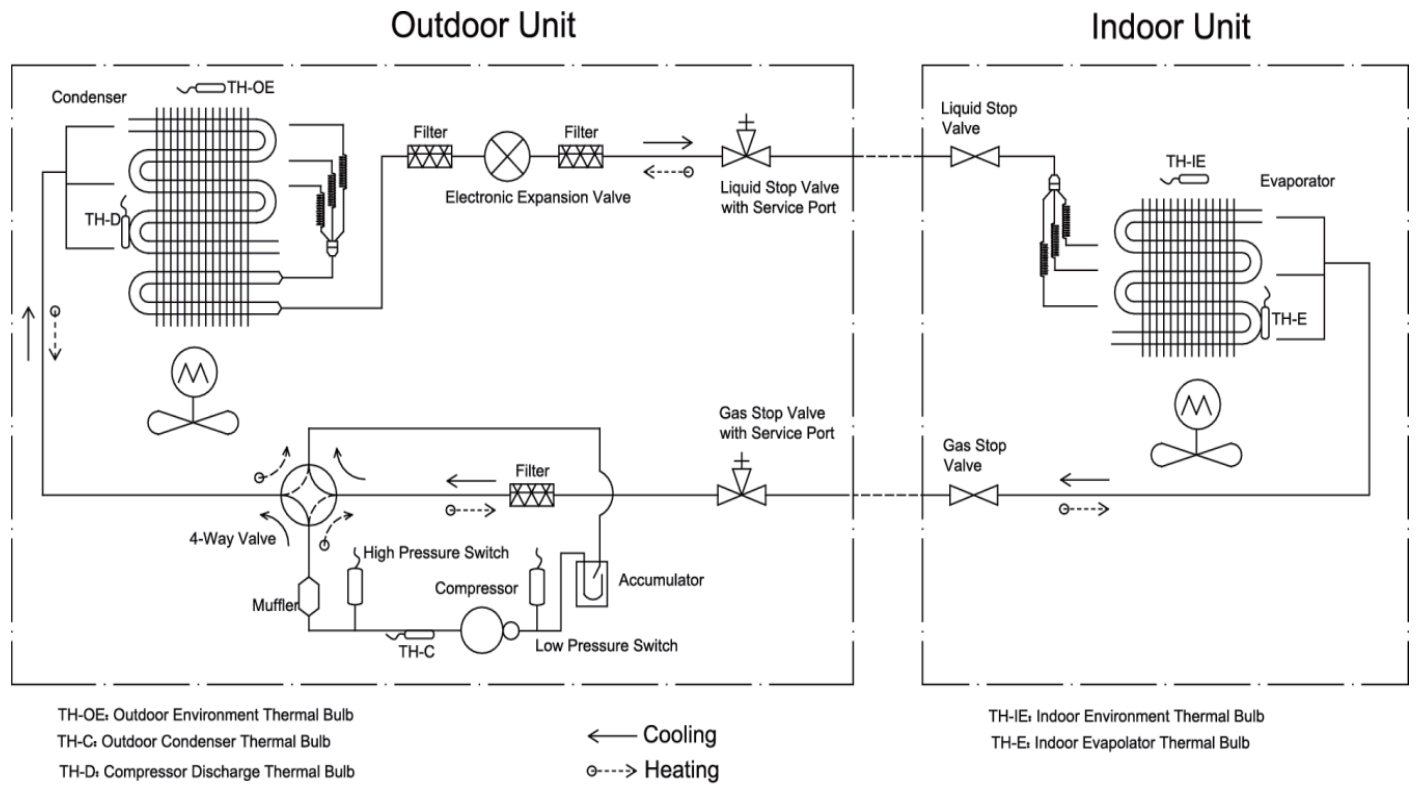

5. Electrical Part

5.1 Wiring Diagram

• Instruction

Symbol	Symbol Color	Symbol	Symbol Color	Symbol	Name
WH	White	GN	Green	CAP	Jumper cap
YE	Yellow	BN	Brown	COMP	Compressor
RD	Red	BU	Blue		Grounding wire
YEGN	Yellow/Green	BK	Black	/	/
VT	Violet	OG	Orange	/	/

Note: Jumper cap is used to determine fan speed and the swing angle of horizontal lover for this model.

• Circuit Diagram

09K, 12K, 18K

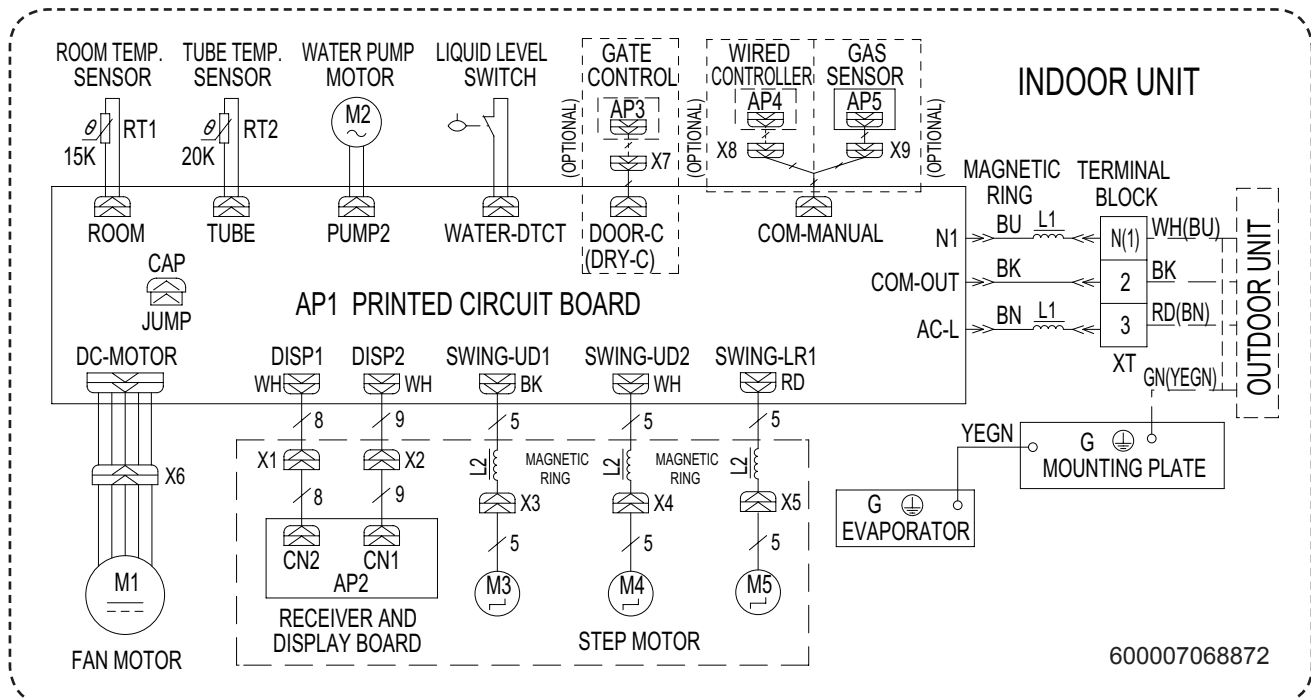

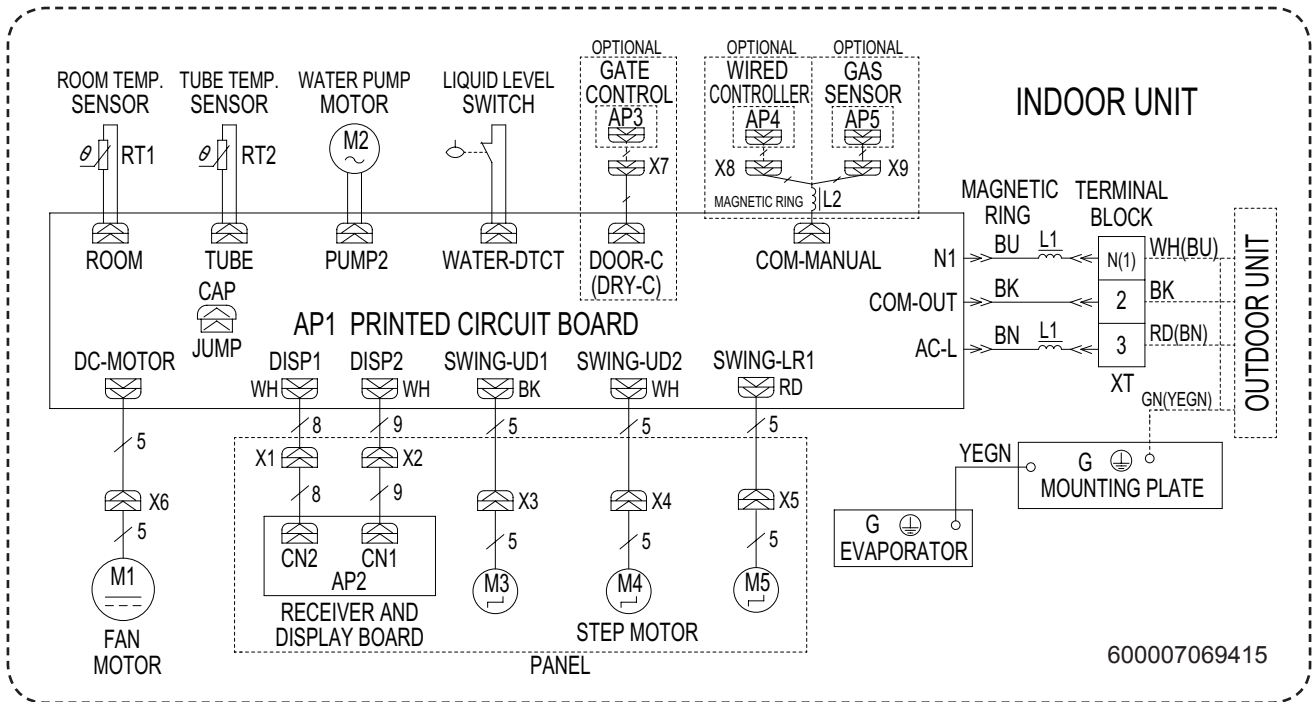

These wiring diagrams are subject to change without notice; please refer to the one supplied with the unit.

6. Function and Control

6.1 Remote Controller Introduction for YBE1FB5F

Buttons on remote controller



Introduction for icons on display screen

	Quiet
	Set fan speed
	Turbo mode
	Send signal
	Auto mode
	Cool mode
	Dry mode
	Fan mode
	Heat mode
	X-FAN function
	Power limiting operation
	Set temperature
	Indoor ambient temp.
	TIMER ON / TIMER OFF
	Set time
	Left & right swing
	Up & down swing
	Child lock
	Air function
	Health function
	WiFi function
	LED
	I feel
	Sleep mode

Introduction for buttons on remote controller

NOTE:

- This is a general use remote controller. It could be used for the air conditioner with multifunction. For the functions which the model doesn't have, if press the corresponding button on the remote controller, the unit will keep the original running status.
- After putting through the power, the air conditioner will give out a sound. Power indicator "⏻" is ON. After that, you can operate the air conditioner by using remote controller.
- Under on status, pressing the button on the remote controller, the signal icon "📶" on the display of remote controller will blink once and the air conditioner will give out a "di" sound, which means the signal has been sent to the air conditioner.

1. On/Off button

Press this button to turn on the unit. Press this button again to turn off the unit.

2. Mode button

Press this button to select your required operation mode:

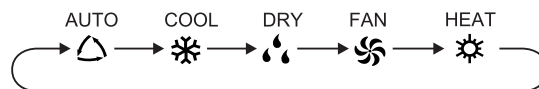

- When selecting auto mode, air conditioner will operate automatically according to ambient temperature. Press "Fan" button can adjust fan speed. Press "🌀" / "🌀" button can adjust fan blowing angle.
- After selecting cool mode, air conditioner will operate under cool mode. Press "+" or "-" button to adjust set temperature. Press "Fan" button to adjust fan speed. Press "🌀" / "🌀" button to adjust fan blowing angle.
- When selecting dry mode, the air conditioner operates at low speed under dry mode. Under dry mode, fan speed can't be adjusted. Press "🌀" / "🌀" button to adjust fan blowing angle.
- When selecting fan mode, the air conditioner will only blow fan, no cooling and no heating. Press "Fan" button to adjust fan speed. Press "🌀" / "🌀" button to adjust fan blowing angle.
- When selecting heat mode, the air conditioner operates under heat mode. Press "+" or "-" button to adjust set temperature. Press "Fan" button to adjust fan speed. Press "🌀" / "🌀" button to adjust fan blowing angle.

6. Function and Control

NOTE:

- For preventing cold air, after starting up heat mode, indoor unit will delay 1~5 minutes to blow air (Actual delay time depends on indoor ambient temperature).
- Set temperature range from remote controller: 61~86°F (16~30°C).
- This mode indicator is not available for some models.
- Cooling only unit won't receive heat mode signal. If setting heat mode with remote controller, press "On/Off" button can't start up the unit.

3. Fan button.

This button is used for setting Fan Speed in the sequence that goes from AUTO, , , , , , to then back to Auto.



- Low speed
- Low-Medium speed
- Medium speed
- Medium-High speed
- High speed
- Turbo speed
- Quiet speed

NOTE:

- It's low fan speed under dry mode.
- X-FAN function: Holding fan speed button for 2s in cool or dry mode, the icon " " is displayed and the indoor fan will continue operation for a few minutes in order to dry the indoor unit even though you have turned off the unit. After energization, X-FAN OFF is defaulted. X-FAN is not available in auto, fan or heat mode.

This function indicates that moisture on evaporator of indoor unit will be blown after the unit is stopped to avoid mould.

- Having set X-FAN function on: After turning off the unit by pressing "On/Off" button, indoor fan will continue running for a few minutes at low speed. In this period, hold fan speed button for 2s to stop indoor fan directly.
- Having set X-FAN function off: After turning off the unit by pressing "On/Off" button, the complete unit will be off directly.

4. - / + button

Press " + " or " - " button once increase or decrease set temperature 1°C(°F). Holding " + " or " - " button, 2s later, set temperature on remote controller will change quickly. On releasing button after setting is finished, temperature indicator on indoor unit will change accordingly.

5. Wifi button

Press "Wifi" button to turn on WiFi function, "Wifi" icon will be displayed on the remote controller; Hold "Wifi" button for

5s to turn off WiFi function and "Wifi" icon will disappear. Under off status, press "Mode" and "Wifi" buttons simultaneously for 1s, WiFi module will restore factory settings.

NOTE:

- This function is only available for some models.

6. Health button

Press this button to turn on or turn off the health and scavenging functions in operation status. Press this button for the first time to start scavenging function; LCD displays " ". Press the button for the second time to start health and scavenging functions simultaneously; LCD displays " " and " ". Press this button for the third time to quit health and scavenging functions simultaneously. Press the button for the fourth time to start health function; LCD display " ".

Press this button again to repeat the operation above.

NOTE:

- This function is only available for some models.

7. UD-swing button

Press this button can select up & down swing angle. Fan blow angle can be selected circularly as below:

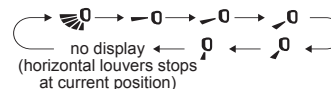

- When selecting " ", air conditioner is blowing fan automatically. Horizontal louver will automatically swing up & down at maximum angle.
- When selecting " , , , , ", air conditioner is blowing fan at fixed position. Horizontal louver will stop at the fixed position.
- Hold " " button above 2s to set your required swing angle. When reaching your required angle, release the button.

NOTE:

- Press this button continuously more than 2s, the main unit will swing back and forth from up to down, and then loosen the button, the unit will stop swinging and present position of guide louver will be kept immediately.
- Under swing up and down mode, when the status is switched from off to , if press this button again 2s later, status will switch to off status directly; if press this button again within 2s, the change of swing status will also depend on the circulation sequence stated above.

8. LR-swing button



Press this button can select left & right swing angle. Fan blow

6. Function and Control

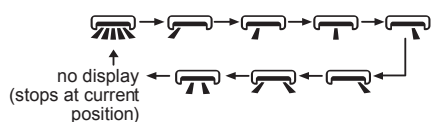

angle can be selected circularly as below:



NOTE:

- Press this button continuously more than 2s, the main unit will swing back and forth from left to right, and then loosen the button, the unit will stop swinging and present position of guide louver will be kept immediately.
- Under swing left and right mode, when the status is switched from off to , if press this button again 2s later,  status will switch to off status directly; if press this button again within 2s, the change of swing status will also depend on the circulation sequence stated above.
- This function only applicable for some models.

9. Clock button

Press this button to set clock time. "  " icon on remote controller will blink. Press "+" or "-" button within 5s to set clock time. Each pressing of "+" or "-" button, clock time will increase or decrease 1 minute. If hold "+" or "-" button, 2s later, time will change quickly. Release this button when reaching your required time. Press "CLOCK" button to confirm the time. "  " icon stops blinking.

NOTE:

- Clock time adopts 24-hour mode.
- The interval between two operations can't exceed 5s. Otherwise, remote controller will quit setting status. Operation for TIMER ON/TIMER OFF is the same.

10. / Timer on / Timer off button

TIMER ON button

• "TIMER ON" button can set the time for timer on. After pressing this button, "  " icon disappears and the word "ON" on remote controller blinks. Press "+" or "-" button to adjust TIMER ON setting. After each pressing "+" or "-" button. TIMER ON setting will increase or decrease 1min. Holding "+" or "-" button, 2s later, the time will change quickly until reaching your required time.

Press "TIMER ON" to confirm it. The word "ON" will stop blinking. "  " icon resumes displaying. Cancel TIMER ON: Under the condition that TIMER ON is started up, press "TIMER ON" button to cancel it.

• TIMER OFF button

"TIMER OFF" button can set the time for timer off. After pressing this button, "  " icon disappears and the word "OFF" on remote

controller blinks. Press "+" or "-" button to adjust TIMER OFF setting. After each pressing "+" or "-" button, TIMER OFF setting will increase or decrease 1min. Holding "+" or "-" button, 2s later, the time will change quickly until reaching your required time.

Press "TIMER OFF" and the word "OFF" will stop blinking. "  " icon resumes displaying. Under the condition that TIMER OFF is started up, press "TIMER OFF" button to cancel it.

11. Light button

Press this button to control the LED status on the displayer, the circulation change is as follow:

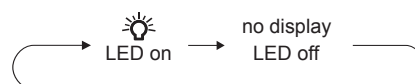

Function introduction for combination buttons



Energy-saving function

Under cooling mode, press "Mode" and "Timer" buttons simultaneously to start up or turn off energy-saving function. When energy-saving function is started up, "SE" will be shown on remote controller, and air conditioner will adjust the set temperature automatically according to ex-factory setting to reach to the best energy-saving effect. Press "Mode" and "Timer" buttons simultaneously again to exit energy-saving function.

NOTE:

- Under energy-saving function, fan speed is defaulted at auto speed and it can't be adjusted.
- Under energy-saving function, set temperature can't be adjusted.
- Sleep function and energy-saving function can't operate at the same time. If energy-saving function has been set under cool mode, press "Sleep" button will cancel energy-saving function. If sleep function has been set under cool mode, start up the energy-saving function will cancel sleep function.

Child lock function

Hold " On/Off " and " - " buttons simultaneously for 3s to turn on or turn off child lock function. When child lock function is on, "  " icon is displayed on remote controller. If you operate the remote controller, the "  " icon will blink three times without sending signal to the unit.

Temperature display switchover function

Under OFF status, hold "Mode" and " - " buttons simultaneously for 3s to switch temperature display between °C and °F.

6. Function and Control

function

function is for limiting power of the whole unit. Press "Mode" and "Sleep" buttons simultaneously, the remote controller will circularly display as the following:

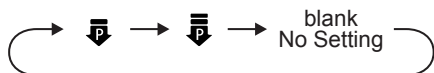

- Maximum power limited under the mode is lower than that of mode.
- If you want to cancel the power limiting function, press "Mode" and "Sleep" buttons simultaneously till the icon in remote controller is not displayed.
- When the remote controller is turned off, power limiting function is cancelled. If you want to activate the function, please repress "Mode" and "Sleep" buttons simultaneously.
- If the current power is lower than the maximum power of mode, then the power will not be limited after entering into such mode.
- For the model with one outdoor unit and two indoor units, if any one of indoor units enters into power limiting function, the outdoor unit will enter into the set limiting power mode of indoor unit; when two indoor units enter into power limiting mode, then the power of outdoor unit will be limited according to the lower power of the two indoor units.

NOTE:

- This function is only available for some models.

Indoor ambient temperature

By holding "On/Off" and " " buttons simultaneously, you can see indoor ambient temperature or indoor ambient humidity on indoor unit's display. The setting on remote controller is selected circularly as below:

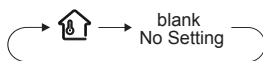

- When selecting " " with remote controller, temperature indicator on indoor unit displays indoor ambient temperature.

Clean reminder function of filter

The reminder function is defaulted to be OFF. Hold "On/Off" and " " buttons simultaneously for 5s to turn it on. The buzzer will give out sound for 0.5s and the dual-8 nixie tube on the display will be on for 3s; Once the reminder function is turned on, when the air conditioner has reached to the set time, the dual-8 nixie tube will flash about 30s when the unit is turned on each time to remind the user to clean the filter; you can turn off this cycle reminder by holding "On/Off" and " " buttons simultaneously for 5s and then the air conditioner will count time again.

NOTE:

- Once the reminder function is turned on, only this cycle reminder can be cleared.
- This function is only available for some models.

Auto clean function

Under unit off status, hold "Mode" and " " buttons simultaneously for 5s to turn on or turn off the auto clean function. When the auto clean function is turned on, indoor unit displays "CL". During the auto clean process of evaporator, the unit will perform fast cooling or fast heating. There may be some noise, which is the sound of flowing liquid or thermal expansion or cold shrinkage. The air conditioner may blow cool or warm air, which is a normal phenomenon. During cleaning process, please make sure the room is well ventilated to avoid affecting the comfort.

NOTE:

- The auto clean function can only work under normal ambient temperature. If the room is dusty, clean it once a month; if not, clean it once every three months. After the auto clean function is turned on, you can leave the room. When auto clean is finished, the air conditioner will enter standby status.
- This function is only available for some models.

Night mode

Under cooling or heating mode, when turning on sleep mode and turn to low speed or quiet notch, the outdoor unit would enter into night mode.

NOTE:

- When you feel that the cooling and heating effect is poor, please press "Fan" button to other fan speed or press "Sleep" button to exit the night mode.
- The night mode can only work under normal ambient temperature.
- This function is only available for some models.

I FEEL function



Press "Health" and " + " buttons simultaneously to start I FEEL function and " " will be displayed on the remote controller. After this function is set, the remote controller will send the detected ambient temperature to the controller and the unit will automatically adjust the indoor temperature according to the detected temperature. Press "Health" and " + " buttons simultaneously again to turn off I FEEL function and " " will disappear.

- Please put the remote controller near user when this function is set. Do not put the remote controller near the object of high temperature or low temperature in order to avoid detecting

6. Function and Control

inaccurate ambient temperature. When I FEEL function is turned on, the remote controller should be put within the area where indoor unit can receive the signal sent by the remote controller.

Sleep function

Press "Clock" and "Light" buttons simultaneously, can select Sleep 1 (), Sleep 2 (), Sleep 3 () and cancel the Sleep, circulate between these, after electrified, Sleep Cancel is defaulted.

- Sleep 1 is Sleep mode 1, in Cool modes: sleep status after run for one hour, the main unit setting temperature will increase 1, two hours, setting temperature increased 2, then the unit will run at this setting temperature; In Heat mode: sleep status after run for one hour, the setting temperature will decrease 1, two hours, setting temperature will decrease 2, then the unit will run at this setting temperature.

- Sleep 2 is sleep mode 2, that is air conditioner will run according to the presetting a group of sleep temperature curve.

- Sleep 3 the sleep curve setting under Sleep mode by DIY;

(1) Under Sleep 3 mode, press "Health" button for a long time, remote controller enters into user individuation sleep setting status, at this time, the time of remote controller will display "1HOUR", the setting temperature "88" will display the corresponding temperature of last setting sleep curve and blink (The first entering will display according to the initial curve setting value of original factory);

(2) Adjust "+" and "-" button, could change the corresponding setting temperature, after adjusted, press "Health" button for confirmation;

(3) At this time, 1hour will be automatically increased at the timer position on the remote control, (that are "2HOUR" or "3HOUR" or "8HOUR"), the place of setting temperature "88" will display the corresponding temperature of last setting sleep curve and blink;

(4) Repeat the above step (2)~(3) operation, until 8 hours temperature setting finished, sleep, curve setting finished, at this time, the remote controller will resume the original timer display; temperature display will resume to original setting temperature.

- Sleep 3 the sleep curve setting under Sleep mode by DIY could be inquired:

The user could accord to sleep curve setting method to inquire the presetting sleep curve, enter into user individuation sleep setting status, but do not change the temperature, press "Health" button directly for confirmation. Note: In the above presetting or enquiry procedure, if continuously within 10s, there is no button pressed, the sleep curve setting within 10s, there is no button pressed, the sleep curve setting status will be automatically quit

and resume to display the original displaying. In the presetting or enquiry procedure, press " On/Off " button, "Mode" button, "Clock" and "Light" buttons simultaneously, the sleep curve setting or enquiry status will quit similarly.

8°C heating function

Under heat mode, press "Mode" and "Clock" buttons simultaneously to start up or turn off 8°C heating function. When this function is started up, "  " and "8°C" will be shown on remote controller, and the air conditioner keep the heating status at 8°C. Press "Mode" and "Clock" buttons simultaneously again to exit 8°C heating function.

NOTE:

- Under 8°C heating function, fan speed is defaulted at auto speed and it can't be adjusted.

- Under 8°C heating function, set temperature can't be adjusted.

- Sleep function and 8°C heating function can't operate at the same time. If 8°C heating function has been set under heat mode, press "Clock" and "Light" buttons simultaneously will cancel 8°C heating function. If sleep function has been set under heat mode, start up the 8°C heating function will cancel sleep function.

- Under °F temperature display, the remote controller will display 46°F heating.

Replacement of batteries in remote controller

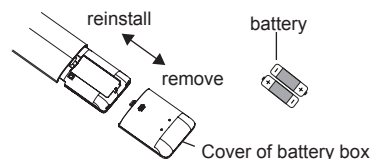

1. Press the back side of remote controller marked with "  ", as shown in the fig, and then push out the cover of battery box along the arrow direction.

2. Replace two 7# (AAA 1.5V) dry batteries, and make sure the position of "+" polar and "-" polar are correct.

3. Reinstall the cover of battery box.

NOTICE:

- During operation, point the remote control signal sender at the receiving window on indoor unit.

- The distance between signal sender and receiving window should be no more than 8m, and there should be no obstacles between them.

- Signal may be interfered easily in the room where there is fluorescent lamp or wireless telephone; remote controller should be close to indoor unit during operation.

- Replace new batteries of the same model when replacement

6. Function and Control

is required.

- When you don't use remote controller for a long time, please take out the batteries.
- If the display on remote controller is fuzzy or there's no display, please replace batteries.

6. Function and Control

6.2 Wired Controller Introduction for XE72-44/E

1 Symbols on LCD

1.1 Outside View of the Wired Controller

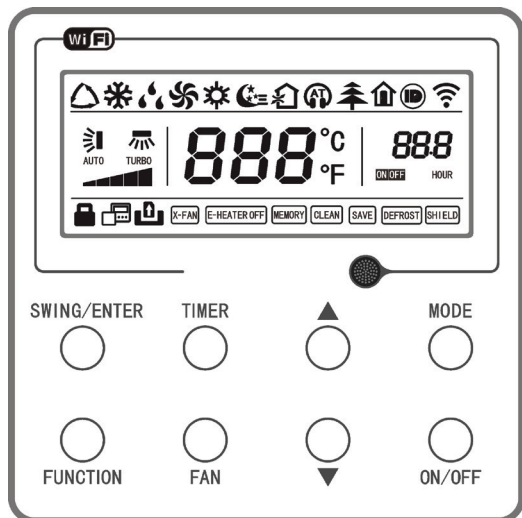

Fig.1 Outside View of the Wired Controller

1.2 LCD of the Wired Controller

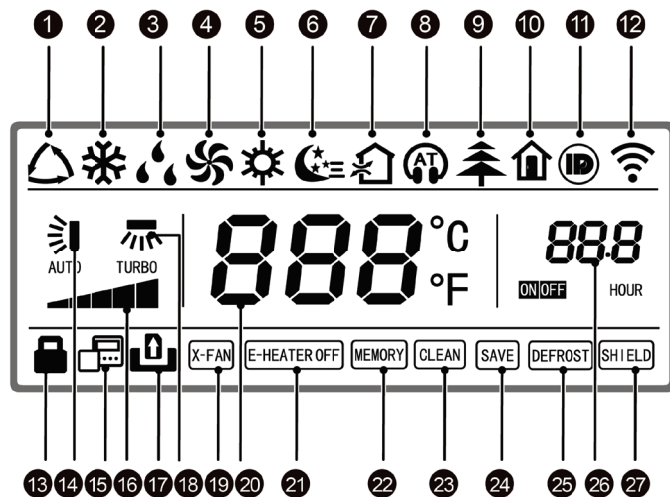

Fig.2 LCD of the Wired Controller

Table 1

No.	Display	Instruction of Display	No.	Display	Instruction of Display
1	Auto	Automatic mode (under auto mode, the indoor unit will select its operating mode according to the variation of room temperature)	15	Slave wired controller	Icon of slave wired controller, it will display when slave wired controller is set (this function is unavailable for this unit)
2	Cool	Cooling mode	16	Fan speed	The fan speed set currently (including auto, low, medium low, medium, medium high, high, and turbo)
3	Dry	Dry mode	17	No card	No card in gate control system
4	Fan	Fan mode	18	Left & right swing	Display when left and right swing function is set
5	Heat	Heating mode	19	X-fan	Display when X-fan function is set
6	Sleep	Display when sleep function is set	20	Temperature	It will display the setting temperature
7	Fresh air	Display when fresh air function is set	21	E-heater	On/off switch of auxiliary heating
8	Quiet	Display when quiet function is set	22	Memory	Memory status (After power failure and reenergizing the unit, it will resume to ON/OFF status of unit before the power failure)
9	Health	Display when health function is set	23	Clean	Filter washing reminder (this function is unavailable for this unit)
10	Absent	Display when absent function is set	24	Save	Display when energy-saving function is set
11	I-DEMAND	Display when I-DEMAND function is set	25	Defrost	Defrosting status
12	WiFi	Display when WiFi function is set	26	Defrost	Display when timer status is set
13	Child-lock	Child-lock status, display when child-lock function is set	27	Shield	Shielding status
14	Up & down swing	Display when up and down swing function is set			

6. Function and Control

2 Buttons

2.1 Buttons on the Wired Controller

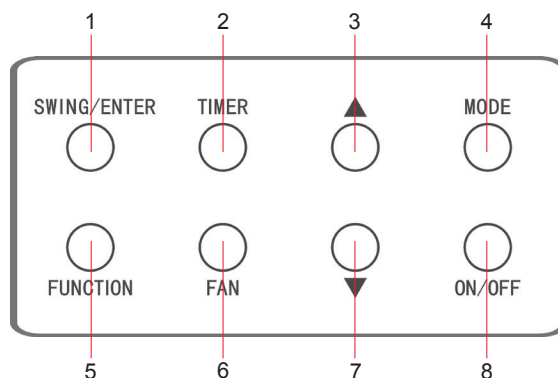

Fig. 3 Buttons on the Wired Controller

2.2 Function of the Buttons

Table 2

No.	Name	Function
1	SWING/ENTER	1. Function selection and cancellation. 2. Setting of the up and down swing function.
3	▲	1. Running temperature setting of the indoor unit, range: 61~86°F(16~30°C). 2. Timer setting, range: 0.5-24 hr.
7	▼	
6	FAN	Setting of the auto/low/medium low/medium/medium high/high fan speed.
4	MODE	Setting of the Cooling/Heating/Fan/Dry/Auto mode of the indoor unit.
5	FUNCTION	Switchover among the functions of Turbo/WiFi/E-heater/X-fan etc..
2	TIMER	TIMER setting.
8	ON/OFF	Turn on/off the indoor unit.
3+4	▲+MODE	Press them for 5s under off state of the unit to Enter/Cancel the Memory function(If memory is set, indoor unit after power failure and then power recovery will resume the original setting state. If not, the indoor unit is defaulted to be off after power recovery. Memory off is default before delivery.).
6+7	FAN+▼	By pressing them at the same time under off state of the unit, ❄ will be displayed on the wired controller for the cooling only unit, while ❄ will be displayed on the wired controller for the cooling and heating unit.
3+7	▲+▼	Upon startup of the unit without malfunction or under off state of the unit, press them at the same time for 5s to enter the lock state, in which case, any other buttons won't respond the press. Repress them for 5 seconds to quit this state.
4+7	MODE+▼	Under OFF state, the Celsius and Fahrenheit scales can be switched by pressing "MODE" and "▼" for 5s.
2+5	TIMER+FUNCTION	Under OFF state, it is available to go to the commissioning status by pressing "FUNCTION" and "TIMER" for five seconds, and let "00" displayed on the temperature display area by pressing "MODE", then adjust the options which is shown on the timer area by pressing "▲" and "▼". There are totally four options, as follows: 1. Indoor ambient temperature is sensed by the return air temperature sensor (01 displayed on the timer area). 2. Indoor ambient temperature is sensed by the wired controller (02 displayed on the timer area). 3. The return air temperature sensor is selected under the cooling, dry, or fan mode; while the wired controller temperature sensor is selected under the heating or auto mode. (03 is displayed on the timer area). 4. The wired controller temperature sensor is selected under the cooling, dry, or fan mode; while the return air temperature sensor is selected under the heating mode. (04 is displayed on the timer display area).
2+5	TIMER+FUNCTION	Under OFF state, it is available to go to the commissioning status by pressing "FUNCTION" and "TIMER" for five seconds. Press "MODE" button to until "01" icon is shown at the temperature display area. The setting status will be shown at timer area. Press "▲" and "▼" button to adjust and two options are available: 1. Three low levels (01); 2. Three high levels (02).
5+6	FUNCTION+FAN	Reset the WiFi function: Under off status, press "FUNCTION" + "FAN" combination buttons on its wired controller for 5s. Once "C" is displayed, this indicates that reset was successful.

6. Function and Control

3 Operation Instructions

3.1 ON/OFF

Press ON/OFF to turn on the unit and turn it off by another press.

NOTE: The state shown in Fig.4 indicates the "OFF" state of the unit after power on. The state shown in Fig.5 indicates the "ON" state of the unit after power on.

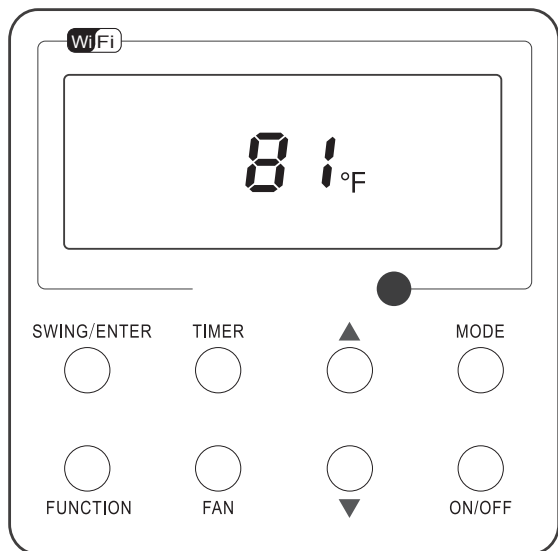

Fig. 4 "OFF" State

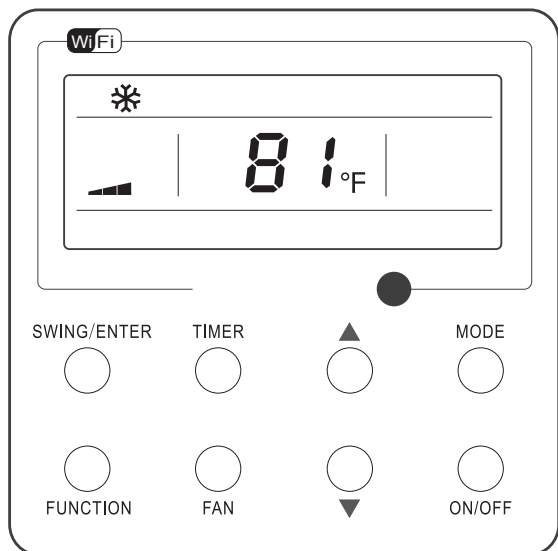
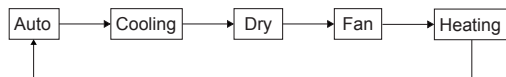

Fig. 5 "ON" State

3.2 Mode Setting

Under the "ON" state of the unit, press MODE to switch the operation modes as the following sequence: Auto-Cooling-Dry-Fan-Heating.



3.3 Temperature Setting

Press ▲ or ▼ to increase/decrease the preset temperature. If press either of them continuously, the temperature will be increased or decreased by 1°C(1°F) every 0.5s, as shown in Fig.6.

In the Cooling, Dry, Fan or Heating mode, the temperature setting range is 16°C~30°C(61°F~86°F).

In the Auto mode, the setting temperature is unadjustable.

NOTE: If the wired controller receives the signals of remote controller, the wired controller can analyze the set temperature adjustment function of automatic mode of the remote controller, but it needs to be used with an indoor unit with the set temperature adjustment function of automatic mode.

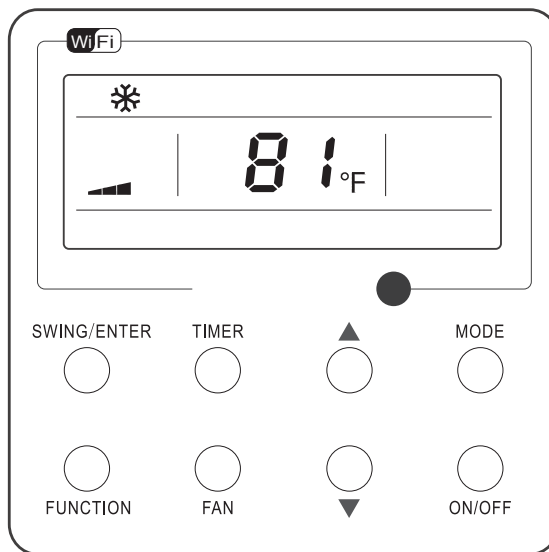

Fig. 6

3.4 Fan Setting

Under the "ON" State of the unit, press Fan and then fan speed of the indoor unit will change circularly as shown in Fig.7.

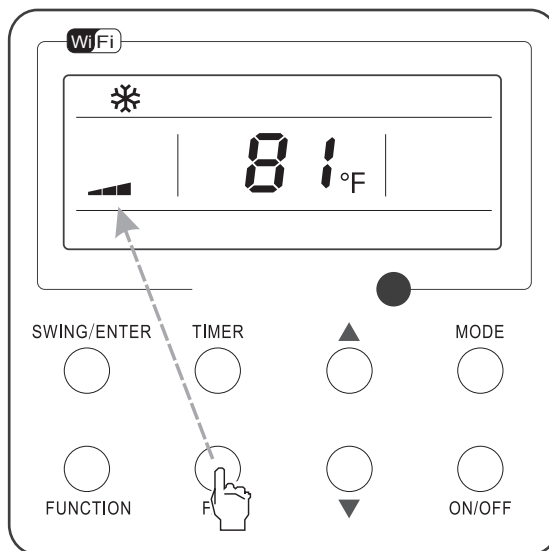
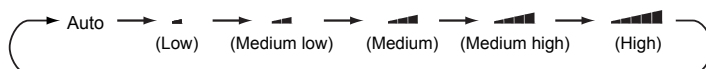

Fig. 7

6. Function and Control

3.5 Timer Setting

Under the "ON" / "OFF" state of the unit, press Timer to set timer off / on.

- Timer on setting: press Timer, and then LCD will display "xx.x hour", with "hour" blinking. In this case press ▲ or ▼ to adjust the timing value. Then press SWING/ENTER to confirm the setting.
- Timer off setting: press Timer, if LCD won't display xx.x hour, and then it means the timer setting is canceled.

Timer off setting under the "ON" state of the unit is shown as Fig.8.

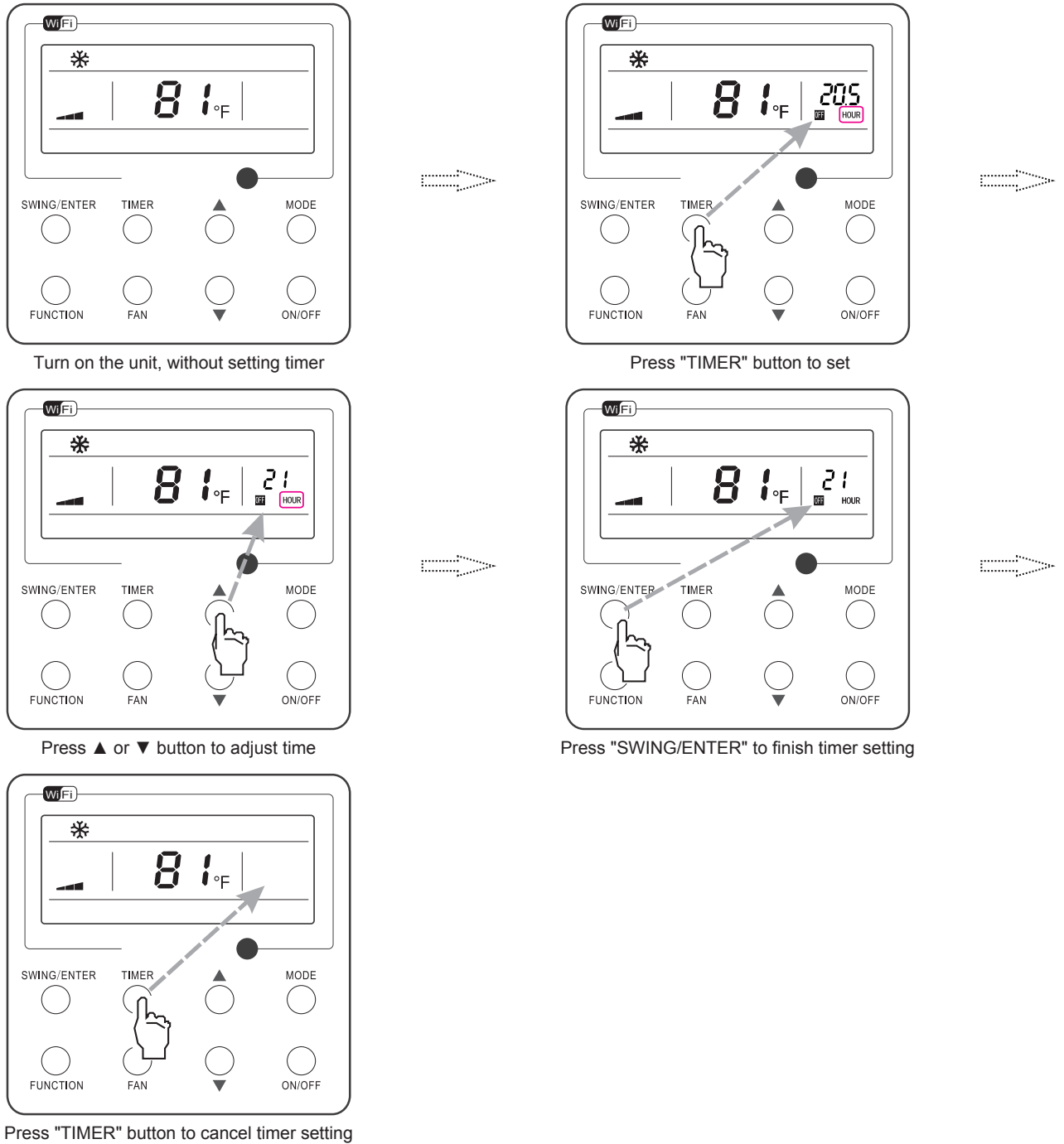

Fig. 8 Timer off Setting under the "ON" State of the Unit

3.6 Up & Down Swing Setting

There are two ways for up and down swing mode: simple swing and fixed swing. Under off status, press "SWING/ENTER" button and "▲" button simultaneously for 5 seconds, then switch for simple swing and fixed swing is done.



When it is set to be simple swing, under on status, press "SWING/ENTER" button, the mode is activated, press the button again the mode is turned off.

When it is set to be fixed swing, press "SWING/ENTER" button, the unit will circularly switch the swing mode according to the order shown below:



6. Function and Control

3.7 Left & Right Swing Setting

- Swing On: Press FUNCTION under on state of the unit to activate the swing function. In this case,  will blink. After that, press SWING/ENTER to make a confirmation.
- Swing Off: When the Swing function is on, press FUNCTION to enter the Swing setting interface, with  blinking. After that, press SWING/ENTER to cancel this function.

Swing setting is shown as Fig.9.

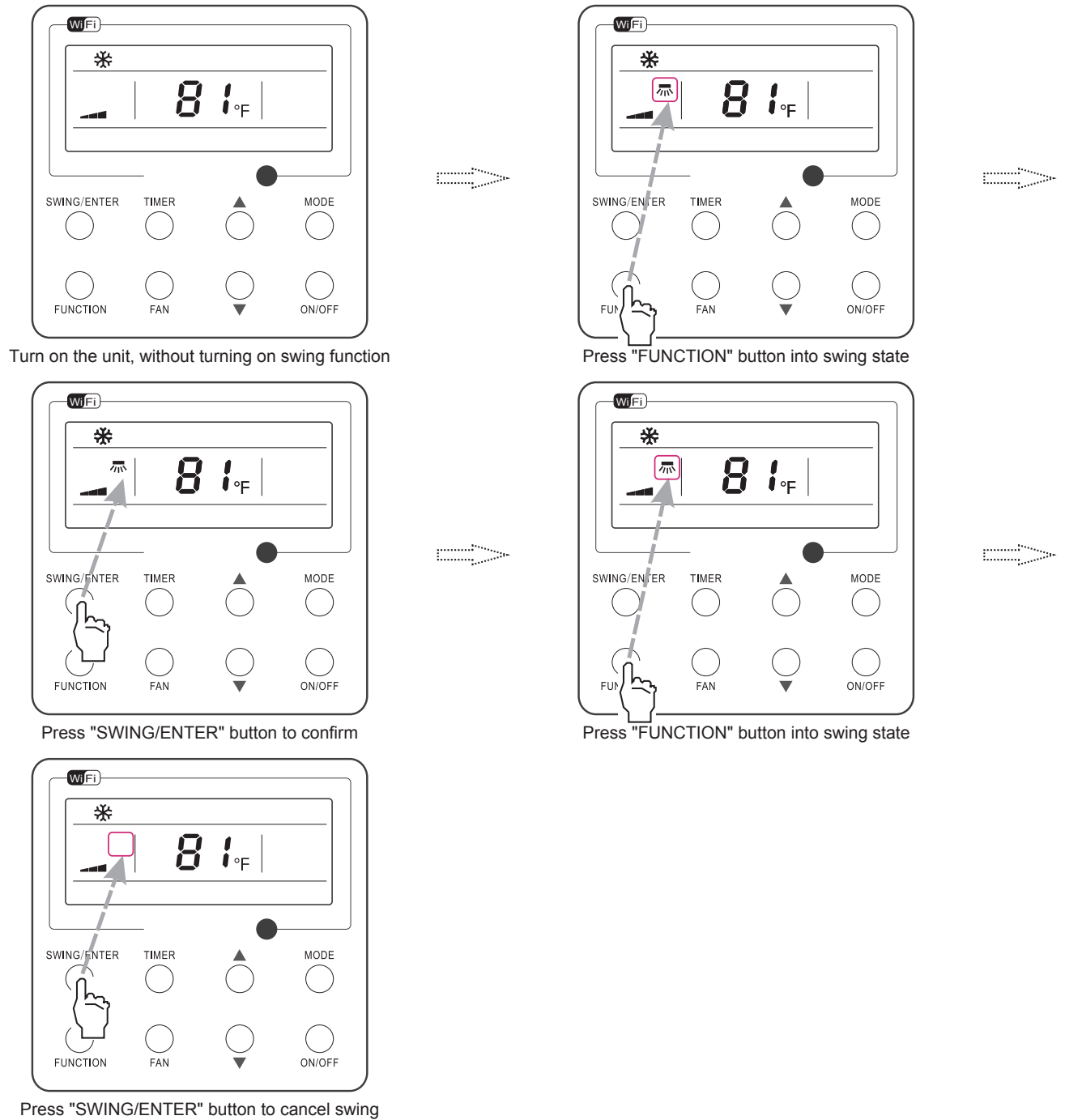



Fig. 9 Swing Setting

- NOTE:**
1. Sleep, Turbo or X-fan setting is the same as the Swing setting.
 2. After the setting has been done, it has to press the key "SWING/ENTER" to back to the setting status or quit automatically five seconds later.

6. Function and Control

3.8 Fresh Air Valve Function Setting

- Turn on fresh air valve function:

Under unit on status, press FUNCTION button on the panel to select "Fresh air valve" function option. When  icon flashes, it enters fresh air valve setting mode. Previous temperature display position will display the level of fresh air valve. Press ▲ or ▼ button to adjust the level of fresh air valve within the range from 1 to 10. Then press SWING/ENTER button to activate this function.

- Turn off fresh air valve function:

If fresh air valve function has been set, press FUNCTION button on the panel to select "Fresh air valve" function option. When icon  flashes, if you press SWING/ENTER button without pressing ▲ or ▼ button, fresh air valve function will be canceled; if you press SWING/ENTER button after pressing ▲ or ▼ button, fresh air valve function will be activated.

NOTE:

1. If you press panel button to set fresh air valve function on, ventilation (ventilation 1) function will be activated too; if you press panel button to set fresh air valve function off, ventilation function will be canceled too.
2. This function is invalid when working with the model with two-way ventilation system.

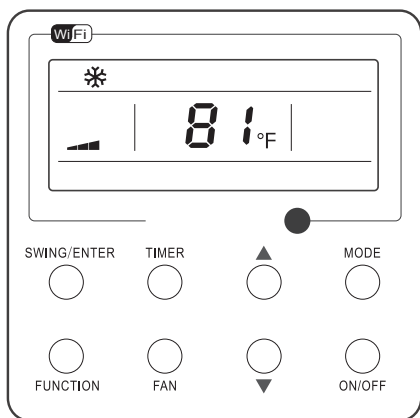

Turn on the unit with the "Fresh Air" function deactivated

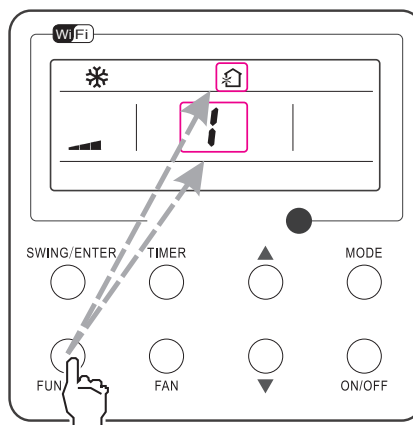

Press "FUNCTION" button to select the "Fresh Air" function option

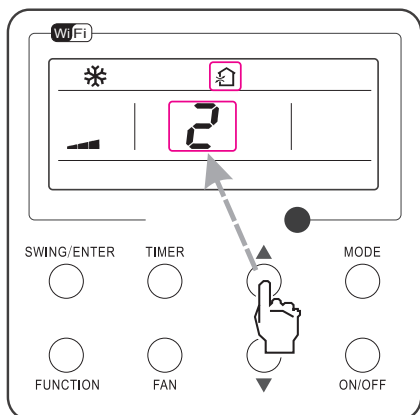

Press ▲ or ▼ to adjust the "Fresh Air" type

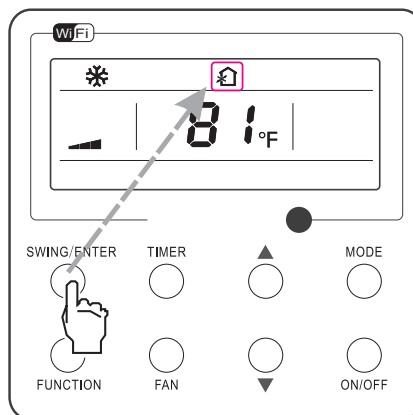

Press "SWING/ENTER" button to activate the "Fresh Air" function

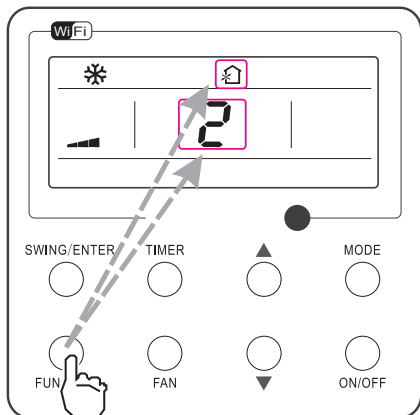

Press "FUNCTION" button to select the "Fresh Air" function option

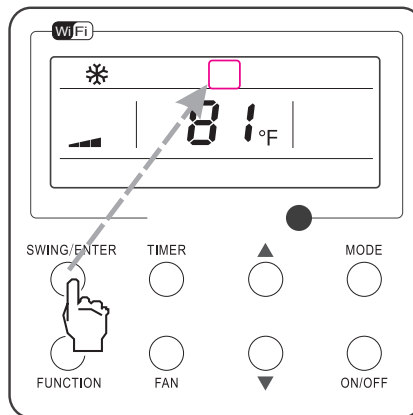

Press "SWING/ENTER" button to deactivate the "Fresh Air" function

Fig. 10 Fresh Air Valve Function Setting

6. Function and Control

3.9 Sleep Setting

- Sleep on: Press FUNCTION under on state of the unit till the unit enters the Sleep setting interface. Press SWING/ENTER to confirm the setting.
- Sleep off: When the Sleep function is activated, press FUNCTION to enter the Sleep setting interface. After that, press SWING/ENTER to can this function.

Sleep setting is shown as Fig.11.

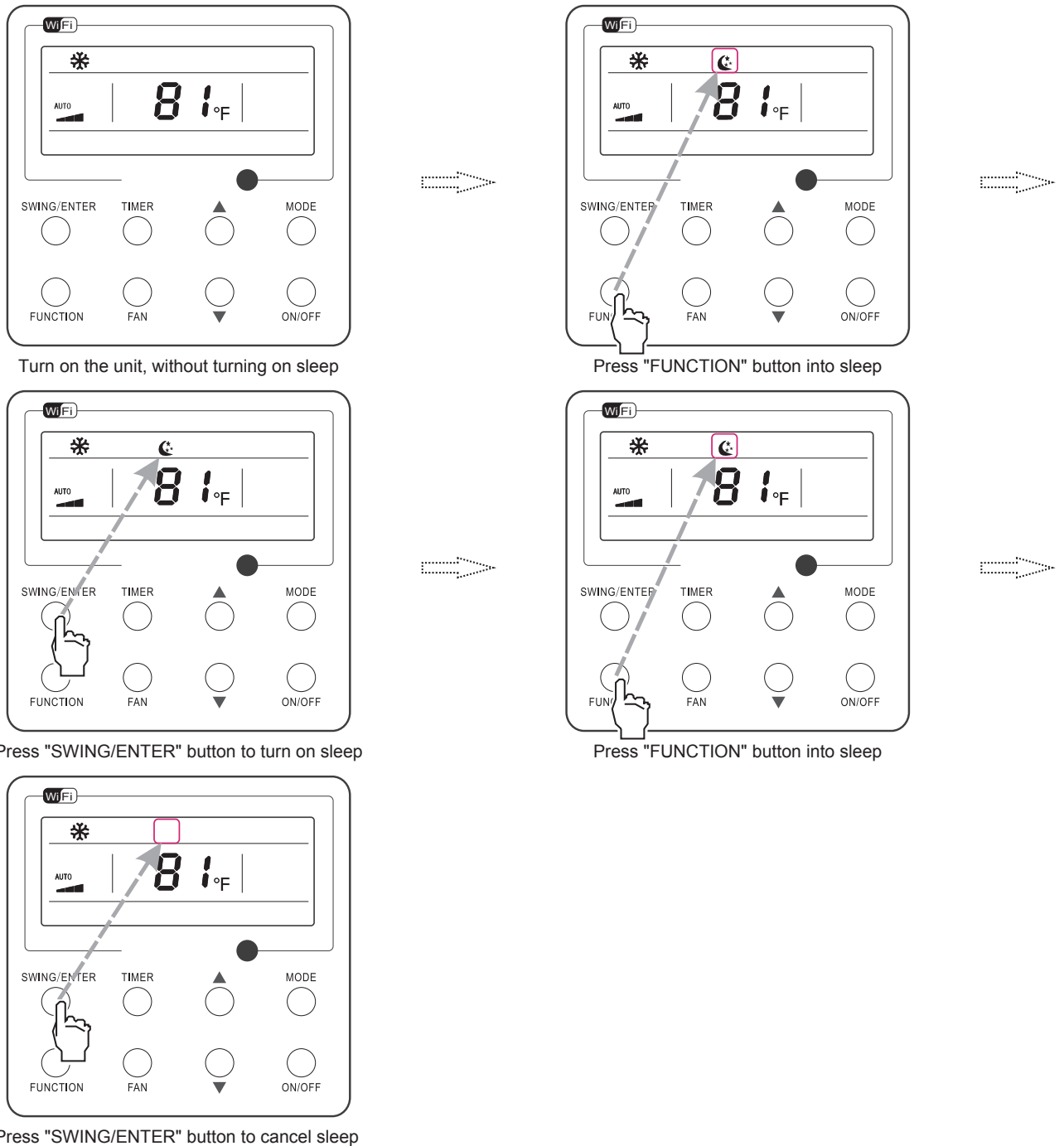

Fig. 11 Sleep Setting

6. Function and Control

3.10 Turbo Setting

Turbo function: The unit at the high fan speed can realize quick cooling or heating so that the room temperature can quickly approach the setting value.

In the Cooling or Heating mode, press FUNCTION till the unit enters the Turbo setting interface and then press SWING/ENTER to confirm the setting.

When the Turbo function is activated, press FUNCTION to enter the Turbo setting interface and then press SWING/ENTER to cancel this function.

Turbo function setting is as shown in Fig.12.

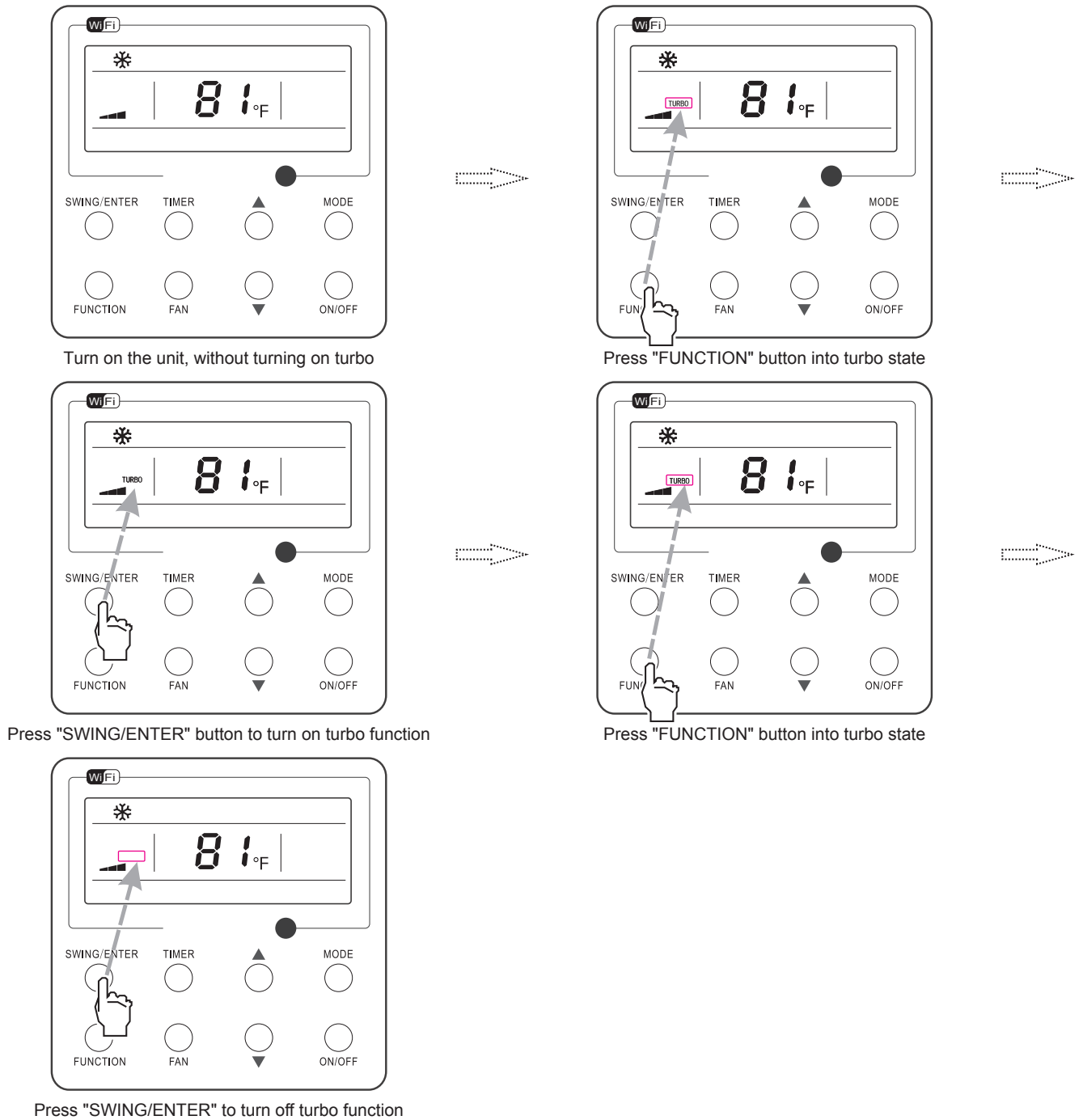

Fig. 12 Turbo Setting

6. Function and Control

3.11 Energy Saving Function Setting

- Turn on energy saving function:

1. Energy Saving Setting for Cooling

When the unit runs under the COOL or DRY mode, press FUNCTION button to select "SAVE" function option, with "SAVE" flashing, and then press ▲ or ▼ to adjust the lower limit, after that, press the SWING/ENTER button to activate this function.

2. Energy Saving Setting for Heating

When the unit runs under the HEAT mode, press FUNCTION button to select "SAVE" function option, with "SAVE" flashing, and then press ▲ or ▼ to adjust the upper limit, after that, press SWING/ENTER button to activate this function.

NOTE: Under energy saving setting mode, press "MODE" button to switch the energy saving setting for COOL or HEAT mode.

- Cancel energy saving function:

If energy saving function has been set, press FUNCTION button on the panel to select "SAVE" function option. When  icon flashes, if you press SWING/ENTER button without pressing ▲ or ▼ button, energy saving function will be canceled; if you press SWING/ENTER button after pressing ▲ or ▼ button, energy saving function will be activated.

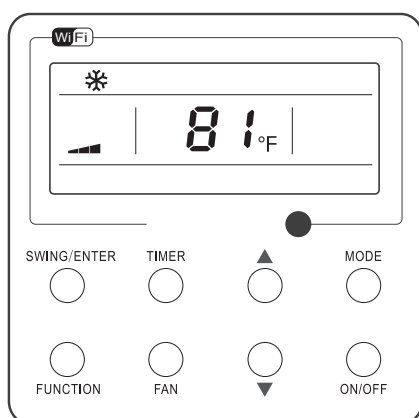

Turn on the unit with the "SAVE" function deactivated

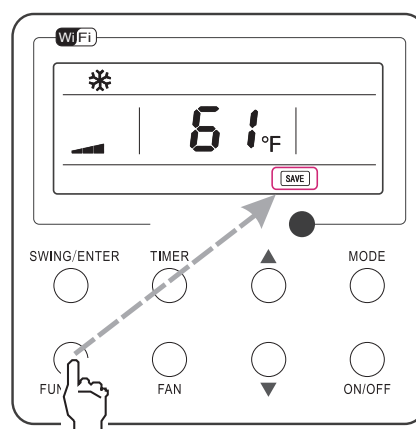

Press "FUNCTION" button to select the "SAVE" function option

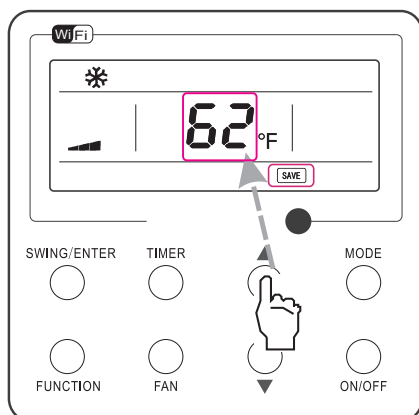

Press ▲ or ▼ to adjust the lower limit

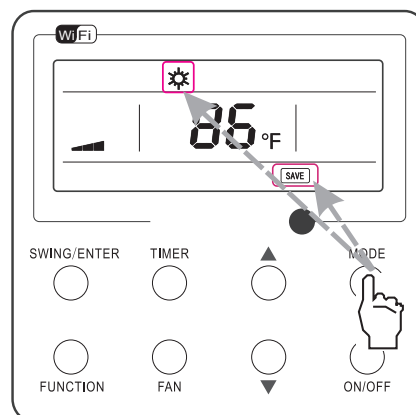

Press "MODE" button to switch to the "SAVE" setting for heating

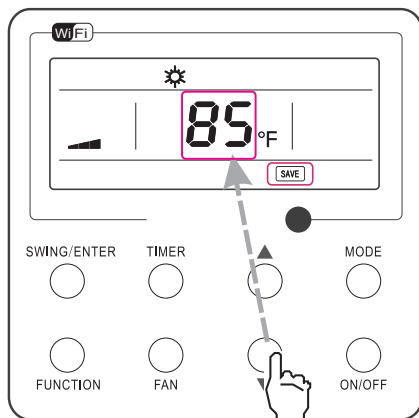

Press ▲ or ▼ to adjust the upper limit

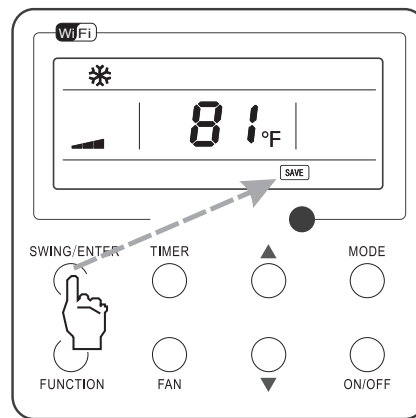

Press "SWING/ENTER" button to activate the "SAVE" function

Fig. 13 Energy Saving Function Setting

6. Function and Control

3.12 E-heater Setting

E-heater (auxiliary electric heating function): In the Heating mode, E-heater is allowed to be turned on for improvement of efficiency. Once the wired controller or the remote controller enters the Heating mode, this function will be turned on automatically.

Press FUNCTION in the Heating mode to enter the E-heater setting interface and then press SWING/ENTER to cancel this function.

Press FUNCTION to enter the E-heater setting interface, if the E-heater function is not activated, and then press SWING/ENTER to turn it on.

The setting of this function is shown as Fig.14 below:

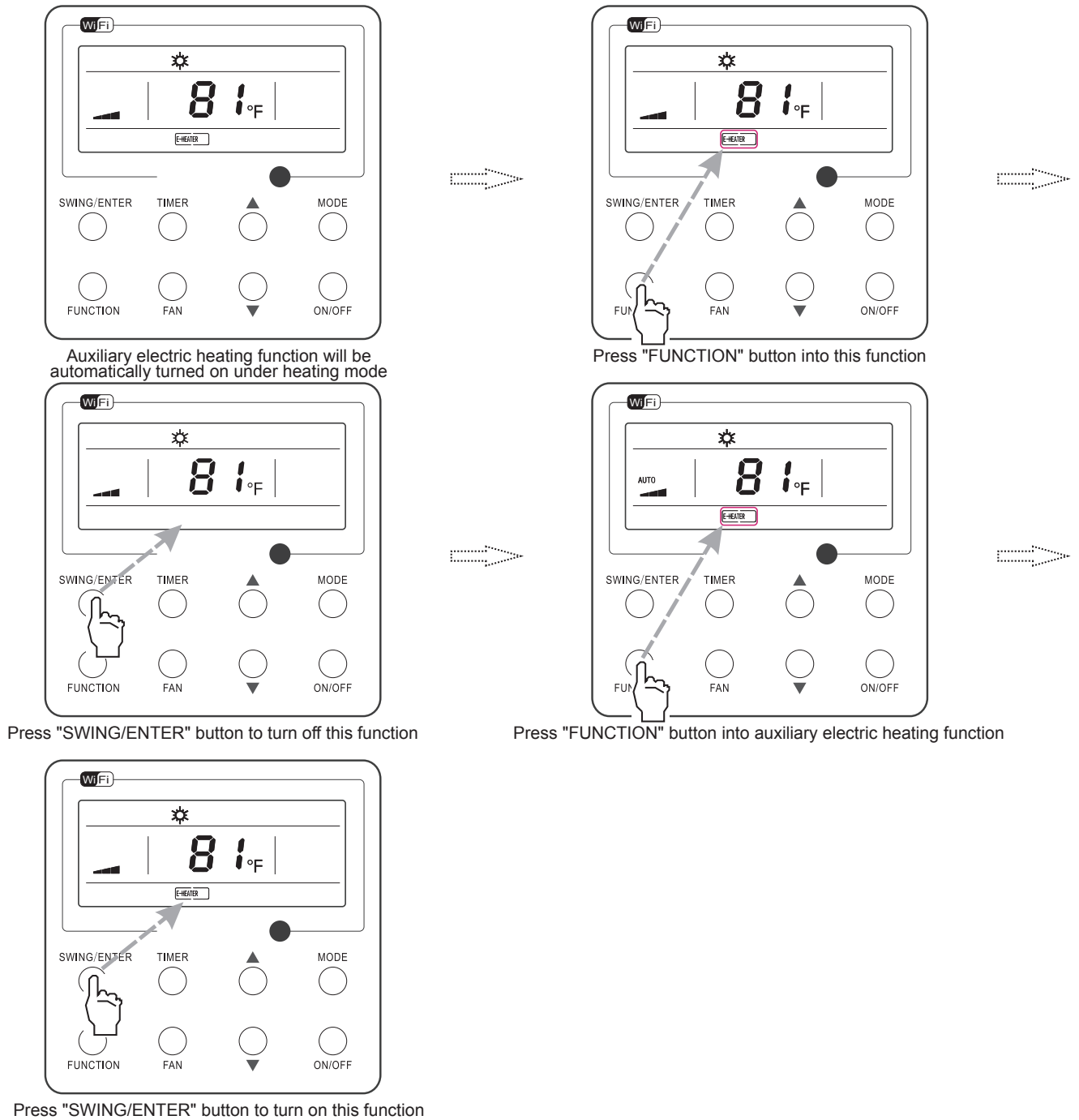

Fig. 14 E-heater Setting

6. Function and Control

3.13 X-fan Setting

X-fan function: After the unit is turned off, the water in evaporator of indoor unit will be automatically evaporated to avoid mildew.

In the Cooling or Dry mode, press FUNCTION till the unit enters the X-fan setting interface and then press SWING/ENTER to activate this function.

When the X-fan function is activated, press FUNCTION to the X-fan setting interface and then press SWING/ENTER to cancel this function.

X-fan function setting is as shown in Fig.15.

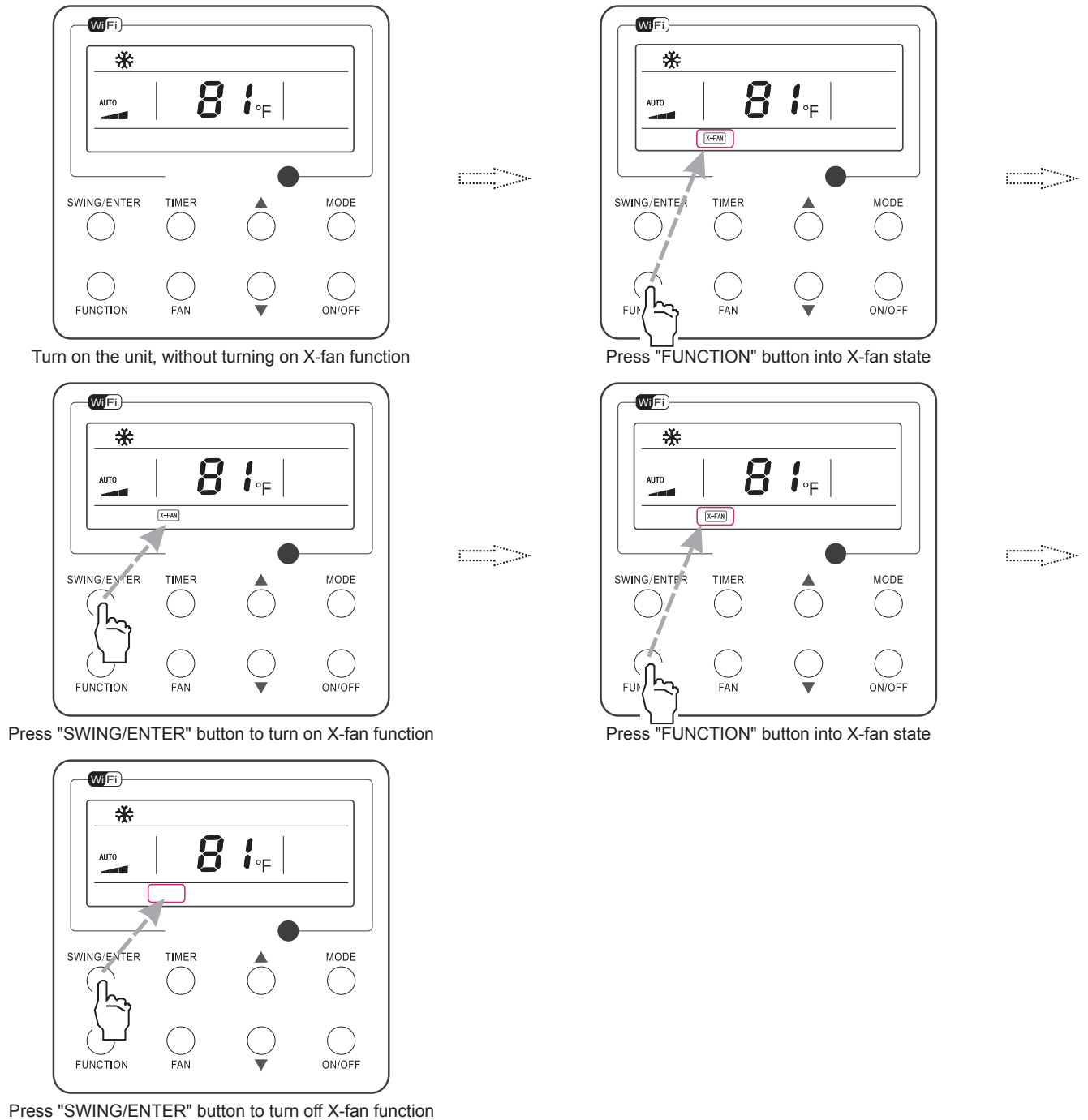

Fig. 15 X-fan Setting

- NOTE:**
1. When the X-fan function is activated, if turning off the unit by pressing ON/OFF or by the remote controller, the indoor fan will run at the low fan speed for 2 minutes, with "X-FAN" displayed on the LCD. While, if the X-fan function is deactivated, the indoor fan will be turned off directly.
 2. X-fan function is unavailable in the Fan or Heating mode.

6. Function and Control

3.14 Quiet Function Setting

- Turn on quiet function:

Under unit on status, press FUNCTION button on the panel to select "Quiet" function option. When "Quiet" or "Auto quiet" flashes, it enters quiet function setting mode. Press ▲ or ▼ button to switch between "Quiet" and "Auto quiet" function. Then press SWING/ENTER button to activate this function.

- Cancel quiet function:

If quiet function has been set, press FUNCTION button on the panel to select "Quiet" function option. When "Quiet" or "Auto quiet" flashes, if you press SWING/ENTER button without pressing ▲ or ▼ button, quiet function will be canceled; if you press SWING/ENTER button after pressing ▲ or ▼ button, quiet function will be activated.

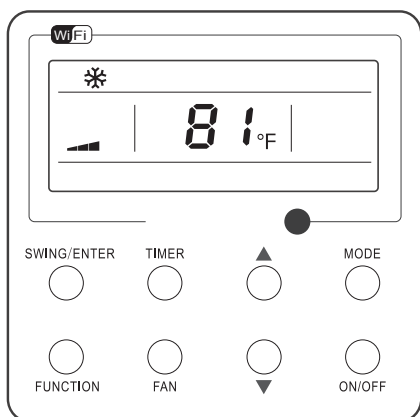

Turn on the unit with the "Quiet" function deactivated

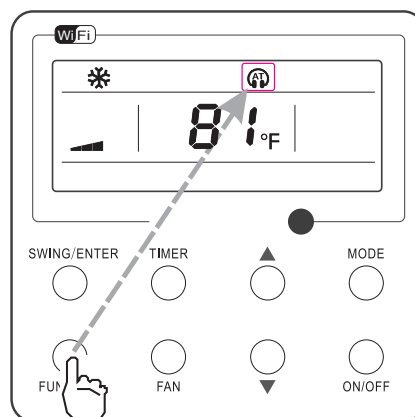

Press "FUNCTION" button to select the "Quiet" function option

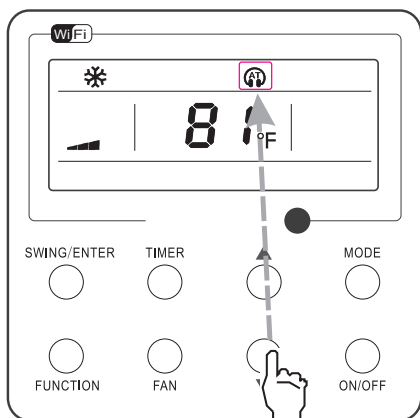

Press ▲ or ▼ to select the desired type, "QUIET" or "AUTO QUIET"

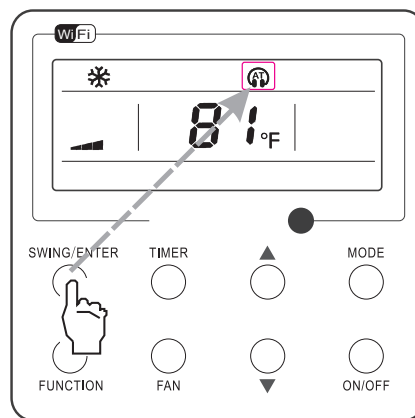

Press "SWING/ENTER" button to activate this function

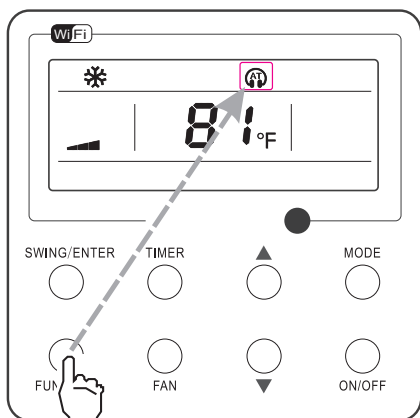

Press the Function button to select the "Quiet" function option

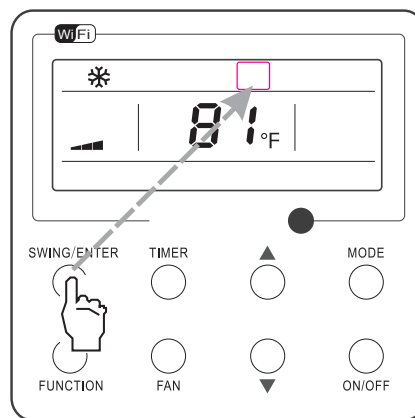

Press "SWING/ENTER" button to deactivate this function

Fig. 16 Setting of Quiet Function

6. Function and Control

3.15 Health Setting

- Health on: Press FUNCTION under on state of the unit till the unit enters the Health setting interface. Press SWING/ENTER to confirm the setting.
- Health off: When the Health function is activated, press FUNCTION to enter the Health setting interface. After that, press SWING/ENTER to cancel this function.

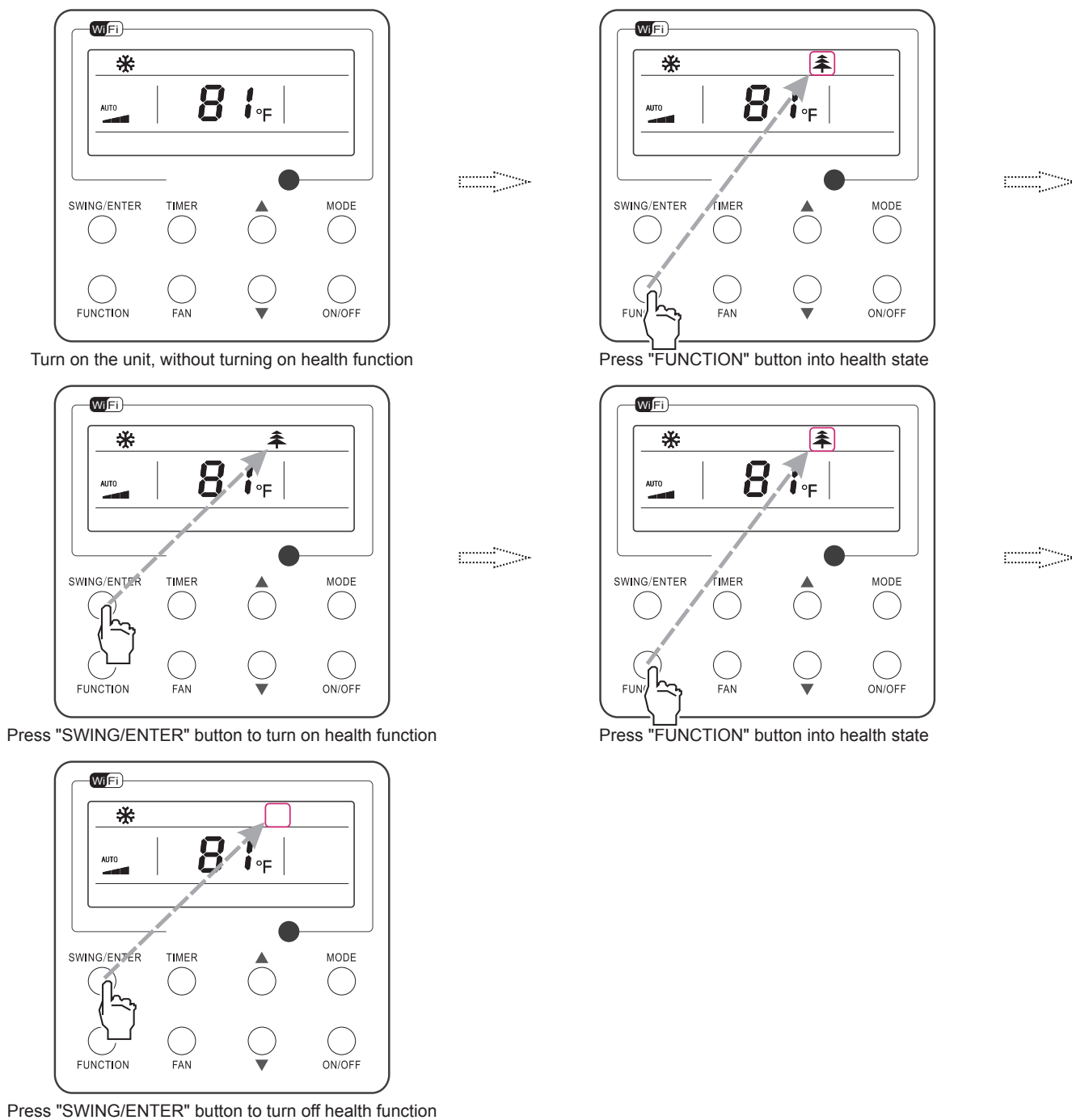

Fig. 17 Health Setting

6. Function and Control

3.16 Absent Setting

- Absent on: Press FUNCTION under on state of the unit till the unit enters the Absent setting interface. Press SWING/ENTER to confirm the setting.
- Absent off: When the Absent function is activated, press FUNCTION to enter the Absent setting interface. After that, press SWING/ENTER to cancel this function.

- NOTE:**
1. This function is only available in heating mode.
 2. When this function has been set, set temperature is displayed in 8°C(46°F). In this case, temperature setting and fan speed setting are shielded.
 3. This function will be cancelled when switching modes.
 4. This function and sleep function cannot be on simultaneously. If Absent function is set firstly and then sleep/quiet function is set, Absent function will be cancelled while sleep function will be valid, and vice versa.

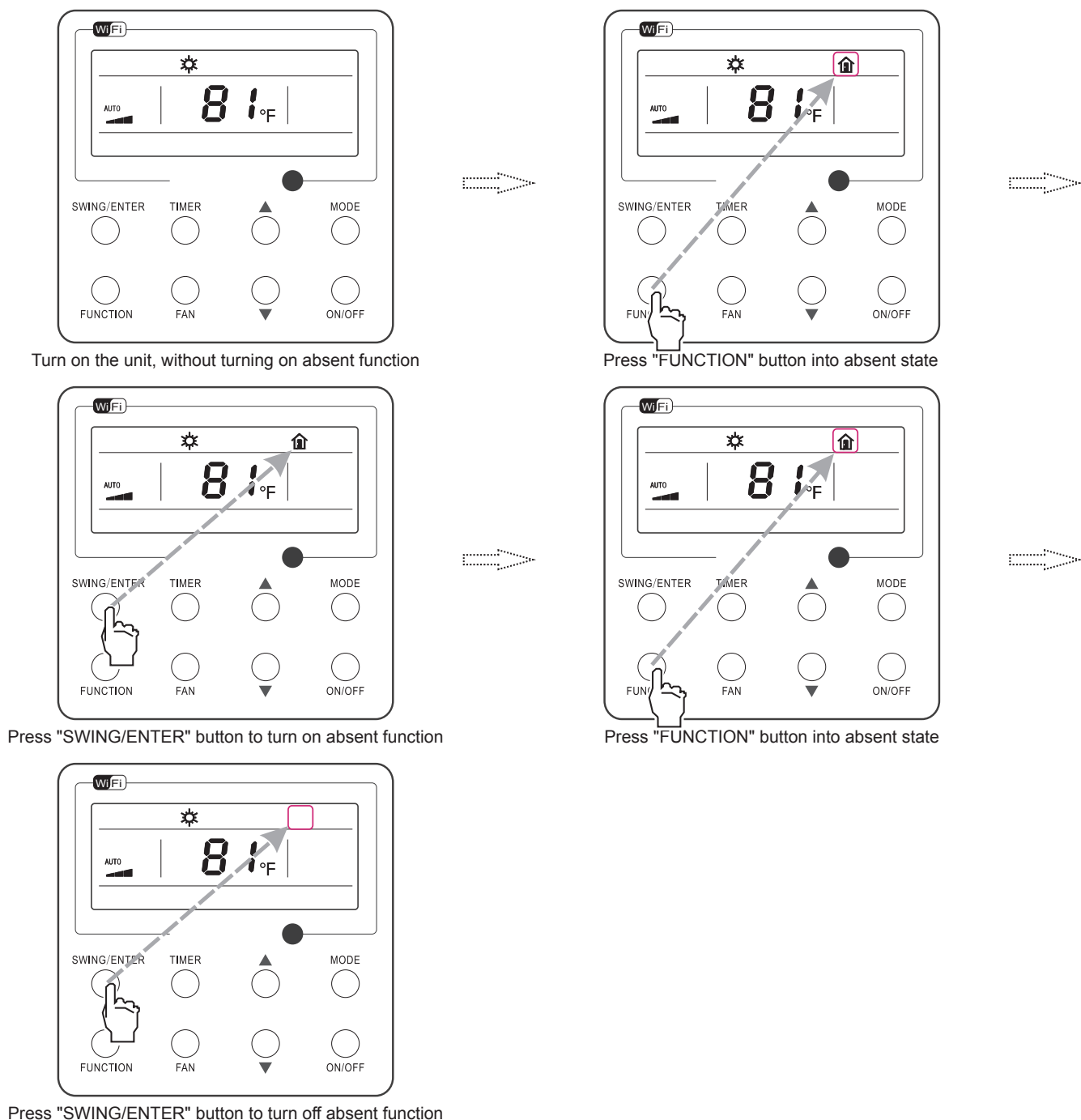

Fig. 18 Absent Setting

6. Function and Control

3.17 I-Demand Setting

- I-Demand on: Press FUNCTION under on state of the unit till the unit enters the I-Demand setting interface. Press SWING/ENTER to confirm the setting.
- I-Demand off: When the I-Demand function is activated, press FUNCTION to enter the I-Demand setting interface. After that, press SWING/ENTER to cancel this function.

- NOTE:**
1. This function is only available in cooling mode.
 2. When this function has been set, set temperature is displayed in SE. In this case, temperature setting and fan speed setting are shielded.
 3. This function will be cancelled when switching modes.
 4. This function and sleep function cannot be on simultaneously. If I-demand function is set firstly and then sleep/quiet function is set, I-demand function will be cancelled while sleep function will be valid, and vice versa.

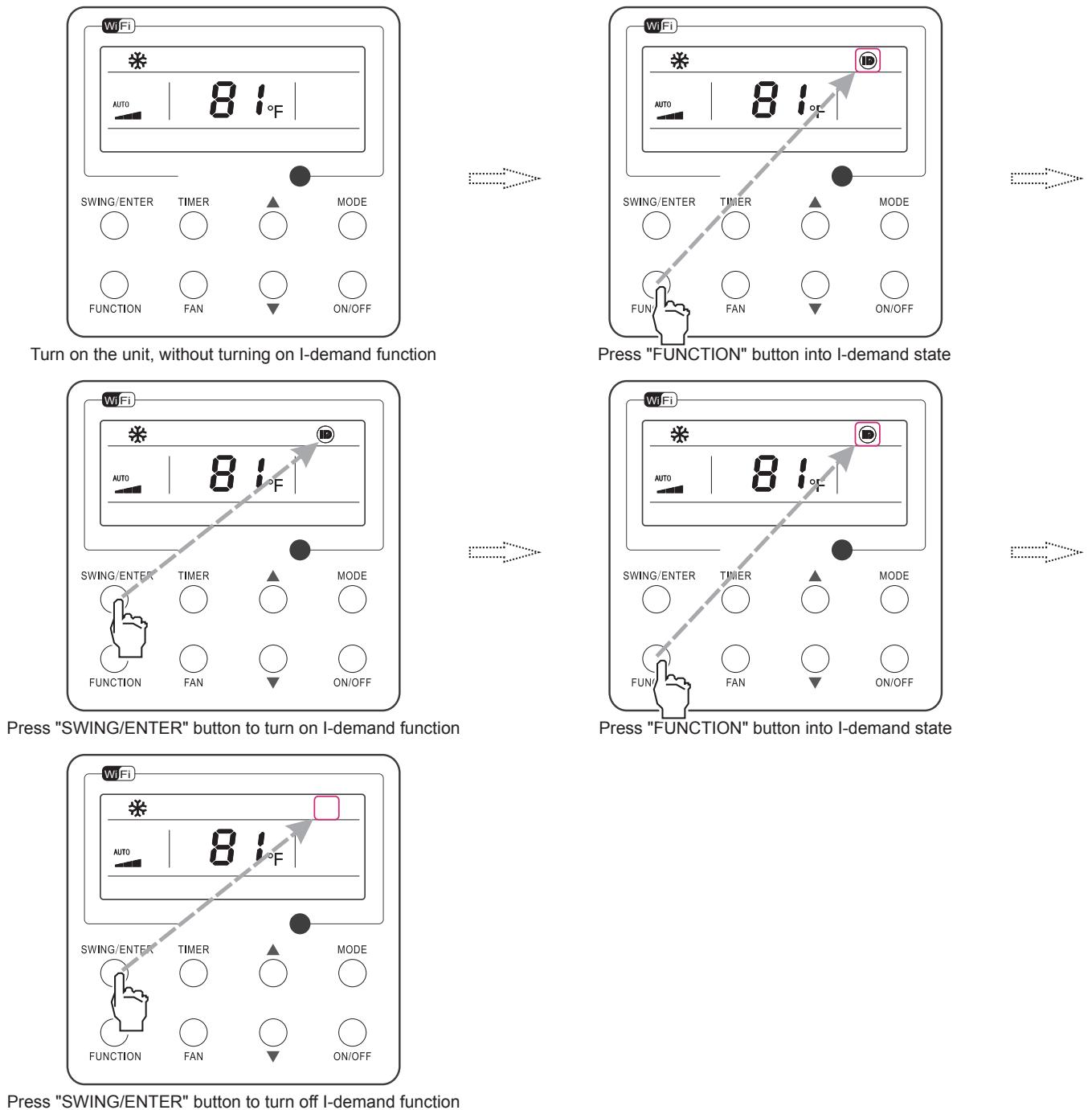

Fig. 19 I-Demand Setting

6. Function and Control

3.18 WiFi Function Setting

"Gree+" APP can be used to control it. Please scan the QR code to download it.

APP can only set some common functions of WiFi wired controller: ON/OFF, mode, set temperature, FAN speed, etc.

When using the APP for the first time, please reset the WiFi function of wired controller (reset WiFi to exfactory setting): Under off status, press "FUNCTION" + "FAN" combination buttons on its wired controller for 5 seconds. Once "°C" is displayed, this indicates that reset was successful.

If there is a communication failure for WiFi, after resetting WiFi, the temperature display area of wired controller displays "JF" for 5 seconds, which indicates that the current reset is invalid.

Press FUNCTION under on state of the unit till the unit enters the WiFi setting interface, the temperature area will display the WiFi status. Press "▲" or "▼" button to turn on WiFi ("ON" is displayed) or turn off WiFi ("OFF" is displayed), and then press "SWING/ENTER" button to confirm it.

3.19 Dred Function Setting

When outdoor unit enters DRED mode: when it detects DRED signal, the whole unit executes DRED mode. When it enters DRED mode, the outdoor unit does timekeeping and feeds back the signal to indoor unit. Under power-on state, the set temperature area displays corresponding code, DRED1, DRED2, DRED3 correspond to "d1", "d2", "d3". The panel cannot be used to set the DRED mode.

When indoor unit enters DRED mode: under power-on state, use "Function" button on the panel to switch to "DRED" function. The set temperature area will display DRED state and flicker. Through "▲" and "▼" buttons can select DRED2 (set temperature area displays d2), DRED3 (set temperature area displays d3), or turn off DRED (set temperature area displays "--"); press "SWING/ENTER" button to confirm the selection, it will display the set state for 3 seconds. After entering the setting, if there is no button operation for 5 seconds, it will quit the interface without saving the setting.

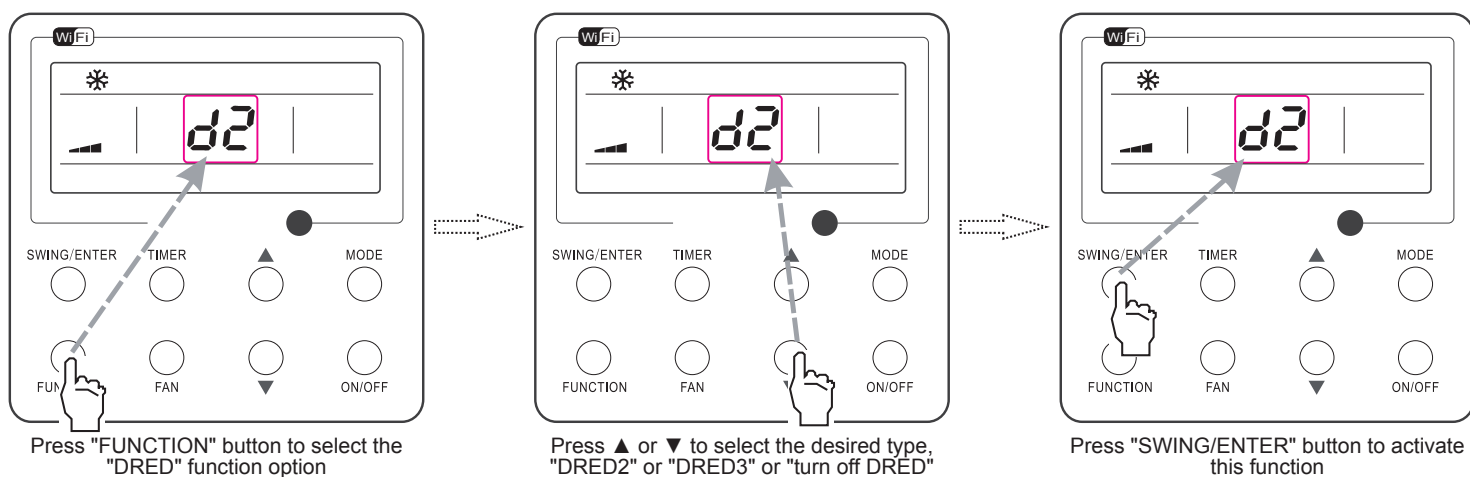

Dred Function Setting

NOTE:

- DRED mode startup method is set by indoor units.
- When outdoor unit enters DRED mode: it does not receive the DRED control of remote control, the whole unit will run the DRED mode, and the wired controller displays the state only.
- When indoor unit enters DRED mode:
 1. When the wired controller receives the DRED command sent from remote control, the set temperature area displays d2 or d3, and it will display for 3 seconds.
 2. Under power-off or air supply mode, the DRED mode is turned off.

6. Function and Control

3.20 Two-way Ventilation Function Setting

Under the "On/Off" state of the unit, press FUNCTION button on the panel to select "Two-way Ventilation" function option. Then press SWING/ENTER button to start up or turn off two-way ventilation function. When two-way ventilation function is started up,  will be shown on wired controller.

- NOTE:**
- Switch to power-off status, two-way ventilation function is turned off.
 - In power-off status, if the two-way ventilation function is activated, fan speed can be adjusted by fan speed button, and quiet or turbo function can be set.
 - This function is invalid when working with the model without two-way ventilation system.

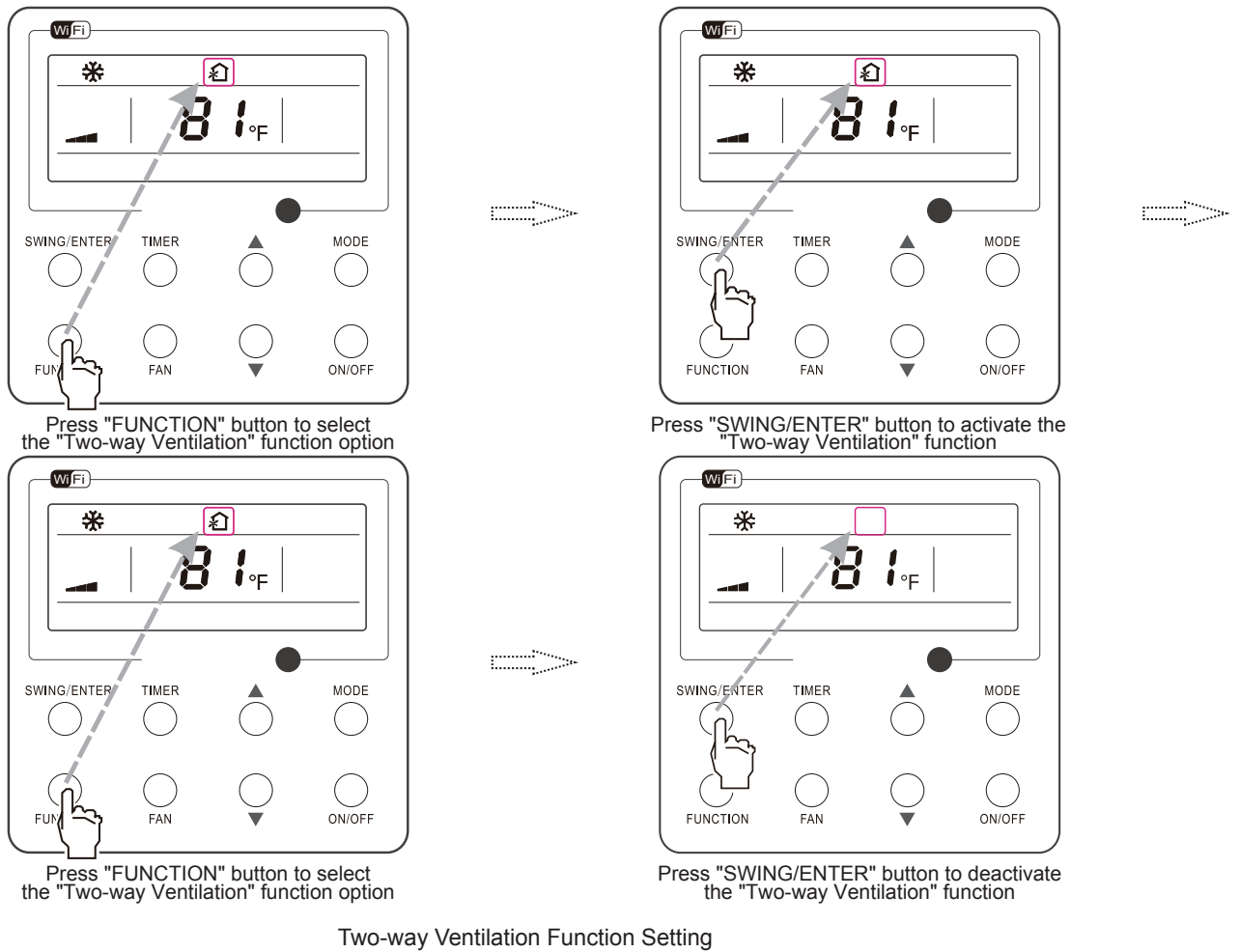

6. Function and Control

3.21 Other Functions

1. Lock

Upon startup of the unit without malfunction or under the "OFF" state of the unit, press and at the same time for 5 seconds till the wired controller enters the Lock function. In this case, LCD displays . After that, repress these two buttons at the same time for 5 seconds to quit this function.

Under the Lock state, any other button press won't get any response.

2. Memory

Memory switchover: Under the "OFF" state of the unit, press Mode and at the same time for 5 seconds to switch memory states between memory on and memory off. When this function is activated, Memory will be displayed. If this function is not set, the unit will be under the "OFF" state after power failure and then power recovery.

Memory recovery: If this function has been set for the wired controller, the wired controller after power failure will resume its original running state upon power recovery. Memory contents: ON/OFF, Mode, set temperature, set fan speed and Lock function.

3. Selection of the Temperature Sensor

Under OFF state of the unit, press both "FUNCTION" and "TIMER" for five seconds to go the commissioning status. Under this status, adjust the display in the temperature display area to "00" through the button "MODE", and then adjust the option of the temperature sensor in the timer display area through the button ▲ or ▼.

- (1) Indoor ambient temperature is sensed at the return air inlet (01 in the timer display area).
- (2) Indoor ambient temperature is the sensed at the wired controller (02 in the timer display area).
- (3) Select the temperature sensor at the return air inlet under the cooling, dry and fan modes, while select the temperature sensor at the wired controller under the heating and auto modes. (03 in the timer display area).
- (4) Select the temperature sensor at the wired controller under the cooling, dry and fan modes, and select the temperature sensor at the return air inlet under the heating mode and auto modes (04 displayed in the timer display area).

After the setting, press "SWING/ENTER" to make a confirmation and quit this setting status.

Pressing the button "ON/OFF" also can quit this commissioning status but the set data won't be memorized.

Under the commissioning status, if there is no any operation in 20 seconds after the last button press, it will back to the previous

state without memorizing the current data.

NOTE:

After connected with indoor unit, if the type of ambient temperature sensor has not been manually set, the wired controller will select the ambient temperature sensor according to the model of connected IDU; if it connects to cassette type IDU, duct type IDU, floor ceiling type IDU, ceiling type IDU, it will adopt (3), otherwise it will adopt (1). If the type of ambient temperature sensor is set manually, the wired controller will subject to the manual setting, and will not set according to automatic IDU model selection.

4. Selection of the Fan Speed

Under OFF state of the unit, press both the buttons "FUNCTION" and "TIMER" for five seconds to go to the commissioning status, and then adjust the display in the temperature display area to 01 through the button "MODE" and adjust the setting of the fan speed, which comes to two options.

01: Three low fan speeds; 02: Three high fan speeds

After the setting, press "SWING/ENTER" to make a confirmation and quit this setting status.

Pressing the button "ON/OFF" also can quit this commissioning status but the set data won't be memorized.

Under the commissioning status, if there is no any operation in 20 seconds after the last button press, it will back to the previous state without memorizing the current data.

5. Inquiry of Ambient Temperature

Under off or on status, press and hold "SWING/ENTER" button for 5 seconds to enter into ambient temperature inquiry interface, then timer area displays the ambient temperature type 01 or 02, and ambient temperature area displays the corresponding ambient temperature of corresponding type. In which, 01 refers to outdoor ambient temperature, 02 refers to indoor ambient temperature. Press "MODE" button can switch between type 01 and 02. Press buttons other than "MODE" or when the unit receives remote control signal, it will quit the inquiry status. If there is no any operation for 5 seconds, it will quit automatically.

6. Function and Control

6.3 Brief Description of Models and Functions

● Indoor Unit

1. Basic function of system

(1) Cooling mode

(1) Under this mode, fan and swing operates at setting status. Temperature setting range is 60.8~86°F.

(2) During malfunction of outdoor unit or the unit is stopped because of protection, indoor unit keeps original operation status.

(2)Drying mode

(1) Under this mode, fan operates at low speed and swing operates at setting status. Temperature setting range is 60.8~86°F.

(2) During malfunction of outdoor unit or the unit is stopped because of protection, indoor unit keeps original operation status.

(3) Protection status is same as that under cooling mode.

(4) Sleep function is not available for drying mode.

(3)Heating mode

(1) Under this mode, Temperature setting range is 60.8~86°F.

(2) Working condition and process for heating mode:

When turn on the unit under heating mode, indoor unit enters into cold air prevention status. When the unit is stopped or at OFF status, and indoor unit has been started up just now, the unit enters into residual heat-blowing status.

(4)Working method for AUTO mode:

1.Working condition and process for AUTO mode:

a.Under AUTO mode, standard heating Tpreset=86°F and standard cooling Tpreset=77°F. The unit will switch mode automatically according to ambient temperature.

2.Protection function

a. During cooling operation, protection function is same as that under cooling mode.

b. During heating operation, protection function is same as that under heating mode.

3. Display: Set temperature is the set value under each condition. Ambient temperature is (Tamb.-Tcompensation) for heat pump unit and Tamb. for cooling only unit.

4. If theres I feel function, Tcompensation is 0. Others are same as above.

(5)Fan mode

Under this mode, indoor fan operates at set fan speed. Compressor, outdoor fan, 4-way valve and electric heating tube stop operation. Indoor fan can select to operate at high, medium, low or auto fan speed. Temperature setting range is 60.8~86°F.

2. Other control

(1) Buzzer

Upon energization or availably operating the unit or remote controller, the buzzer will give out a beep.

(2) Auto button

If press this auto button when turning off the unit, the complete unit will operate at auto mode. Indoor fan operates at auto fan

speed and swing function is turned on. Press this auto button at ON status to turn off the unit.

(3) Auto fan

Heating mode: During auto heating mode or normal heating ode, auto fan speed will adjust the fan speed automatically according to ambient temperature and set temperature.

(4) Sleep

After setting sleep function for a period of time, system will adjust set temperature automatically.

(5) Timer function:

General timer and clock timer functions are compatible by equipping remote controller with different functions.

(6) Memory function

memorize compensation temperature, off-peak energization value.

Memory content: mode, up&down swing, light, set temperature, set fan speed, general timer (clock timer Can't be memorized).

After power recovery, the unit will be turned on automatically according to memory content.

(7) Health function

During operation of indoor fan, set health function by remote controller. Turn off the unit will also turn off health function.

Turn on the unit by pressing auto button, and the health is defaulted ON.(Health function is not available for this unit)

(8)I feel control mode

After controller received I feel control signal and ambient temperature sent by remote controller, controller will work according to the ambient temperature sent by remote controller.

(9)Compulsory defrosting function

(1) Start up compulsory defrosting function

Under ON status, set heating mode with remote controller and adjust the temperature to 60.8°F.Press “△, ▽, △, ▽, △, ▽” button successively within 5s and the complete unit will enter into compulsory defrosting status. Meanwhile, heating indicator on indoor unit will ON 10s and OFF 0.5s successively. (Note: If complete unit has malfunction or stops operation due to protection, compulsory defrosting function can be started up after malfunction or protection is resumed.

(2) Exit compulsory defrosting mode

After compulsory defrosting is started up, the complete unit will exit defrosting operation according to the actual defrosting result, and the complete unit will resume normal heating operation.

(10)Refrigerant recovery function:

(1) Enter refrigerant recycling function

Within 5min after energizing (unit ON or OFF status is ok), continuously press LIGHT button for 3 times within 3s to enter refrigerant recycling mode; Fo is displayed and refrigerant recycling function is started. At this moment, the maintenance people closes liquid valve.

After 5min, stick the thimble of maintenance valve with a tool. If there is no refrigerant spraying out, close the gas valve immediately and then turn off the unit to remove the connection

6. Function and Control

pipe.

(2) Exit refrigerant recycling function

After entering refrigerant recycling mode, when receive any remote control signal or enter refrigerant recycling mode for 25min, the unit will exit refrigerant recycling mode automatically. If the unit is in standby mode before refrigerant recycling, it will be still in standby mode after finishing refrigerant recycling; if the unit is in ON status before refrigerant recycling, it will still run in original operation mode.

(11) Ambient temperature display control mode

1. When user set the remote controller to display set temperature (corresponding remote control code: 01), current set temperature will be displayed.

2. Only when remote control signal is switched to indoor ambient temperature display status (corresponding remote control code: 10) from other display status (corresponding remote control code: 00, 01, 11), controller will display indoor ambient temperature for 3s and then turn back to display set temperature.

Under this mode, indoor fan operates at set fan speed. Compressor, outdoor fan, 4-way valve and electric heating tube stop operation. Indoor fan can select to operate at high, medium, low or auto fan speed. Temperature setting range is 60.8~86°F.

(12) Off-peak energization function:

Adjust compressors minimum stop time. The original minimum stop time is 180s and then we change to:

The time interval between two start-ups of compressor Can't be less than $180+T_s(0 \leq T \leq 15)$. T is the variable of controller. That's to say the minimum stop time of compressor is 180s~195s. Read-in T into memory chip when refurbish the memory chip each time. After power recovery, compressor can only be started up after $180+T$ s at least.

(13) SE control mode

The unit operates at SE status.

(14) X-fan mode

When X-fan function is turned on, after turn off the unit, indoor fan will still operate at low speed for 2min and then the complete unit will be turned off. When x-fan function is turned off, after turn off the unit, the complete unit will be turned off directly.

(15) 8°C heating function

Under heating mode, you can set 46.4°F heating function by remote controller. The system will operate at 46.4°F set temperature.

(16) Turbo function

Turbo function can be set under cooling and heating modes. Press Fan Speed button to cancel turbo setting. Turbo function is not available under auto, drying and fan modes.

(17) Instructions to the Error Indicating Lamps on the Panel of the Cassette Type Unit.

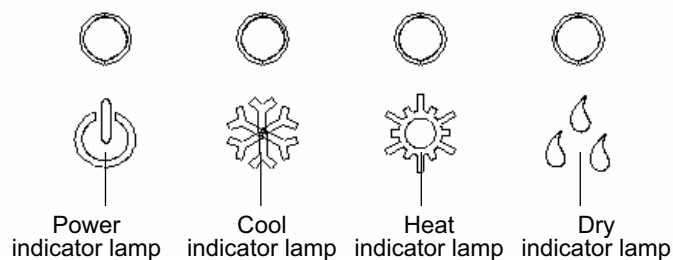

7. Notes for Installation and Maintenance

Safety Precautions: Important!

Please read the safety precautions carefully before installation and maintenance.

The following contents are very important for installation and maintenance.

Caution: Installation Must be Performed in Accordance with the NEC/CEC by Authorized Personnel Only.

Please follow the instructions below.

- The installation or maintenance must accord with the instructions.
- Comply with all national electrical codes and local electrical codes.
- Pay attention to the warnings and cautions in this manual.
- All installation and maintenance shall be performed by distributor or qualified person.
- All electric work must be performed by a licensed technician according to local regulations and the instructions given in this manual.
- Be caution during installation and maintenance. Prohibit incorrect operation to prevent electric shock, casualty and other accidents.



WARNINGS

Electrical Safety Precautions:

1. Cut off the power supply of air conditioner before checking and maintenance.
2. The air condition must apply specialized circuit and prohibit share the same circuit with other appliances.
3. The air conditioner should be installed in suitable location and ensure the power plug is touchable.
4. Make sure each wiring terminal is connected firmly during installation and maintenance.
5. Have the unit adequately grounded. The grounding wire can't be used for other purposes.
6. Must apply protective accessories such as protective boards, cable-cross loop and wire clip.
7. The live wire, neutral wire and grounding wire of power supply must be corresponding to the live wire, neutral wire and grounding wire of the air conditioner.
8. The power cord and power connection wires can't be pressed by hard objects.
9. If power cord or connection wire is broken, it must be replaced by a qualified person.
10. If the power cord or connection wire is not long enough, please get the specialized power cord or connection wire

from the manufacture or distributor. Prohibit prolong the wire by yourself.

11. For the air conditioner without plug, an air switch must be installed in the circuit. The air switch should be all-pole parting and the contact parting distance should be more than 3mm.
12. Make sure all wires and pipes are connected properly and the valves are opened before energizing.
13. Check if there is electric leakage on the unit body. If yes, please eliminate the electric leakage.
14. Replace the fuse with a new one of the same specification if it is burnt down; Don't replace it with a cooper wire or conducting wire.
15. If the unit is to be installed in a humid place, the circuit breaker must be installed.

Installation Safety Precautions:

1. Select the installation location according to the requirement of this manual. (See the requirements in installation part)
2. Handle unit transportation with care; the unit should not be carried by only one person if it is more than 20kg.
3. When installing the indoor unit and outdoor unit, a sufficient fixing bolt must be installed; make sure the installation support is firm.
4. Ware safety belt if the height of working is above 2m.
5. Use equipped components or appointed components during installation.
6. Make sure no foreign objects are left in the unit after finishing installation.

Refrigerant Safety Precautions:

1. When refrigerant leaks or requires discharge during installation, maintenance, or disassembly, it should be handled by certified professionals or otherwise in compliance with local laws and regulations.
2. Avoid contact between refrigerant and fire as it generates poisonous gas; Prohibit prolong the connection pipe by welding.
3. Apply specified refrigerant only. Never have it mixed with any other refrigerant. Never have air remain in the refrigerant line as it may lead to rupture or other hazards.
4. Make sure no refrigerant gas is leaking out when installation is completed.
5. If there is refrigerant leakage, please take sufficient measure to minimize the density of refrigerant.
6. Never touch the refrigerant piping or compressor without wearing glove to avoid scald or frostbite.

Improper installation may lead to fire hazard, explosion, electric shock or injury.

7. Notes for Installation and Maintenance

Safety Precautions for Installing and Relocating the Unit:

To ensure safety, please be mindful of the following precautions.

WARNINGS

1. When installing or relocating the unit, be sure to keep the refrigerant circuit free from air or substances other than the specified refrigerant.

Any presence of air or other foreign substance in the refrigerant circuit will cause system pressure rise or compressor rupture, resulting in injury.

2. When installing or moving this unit, do not charge the refrigerant which is not comply with that on the nameplate or unqualified refrigerant.

Otherwise, it may cause abnormal operation, wrong action, mechanical malfunction or even series safety accident.

3. When refrigerant needs to be recovered during relocating or repairing the unit, be sure that the unit is running in cooling mode. Then, fully close the valve at high pressure side (liquid valve). About 30~40 seconds later, fully close the valve at low pressure side (gas valve), immediately stop the unit and disconnect power. Please note that the time for refrigerant recovery should not exceed 1 minute.

If refrigerant recovery takes too much time, air may be sucked in and cause pressure rise or compressor rupture, resulting in injury.

4. During refrigerant recovery, make sure that liquid valve and gas valve are fully closed and power is disconnected before detaching the connection pipe.

If compressor starts running when stop valve is open and connection pipe is not yet connected, air will be sucked in and cause pressure rise or compressor rupture, resulting in injury.

5. When installing the unit, make sure that connection pipe is securely connected before the compressor starts running.

If compressor starts running when stop valve is open and connection pipe is not yet connected, air will be sucked in and cause pressure rise or compressor rupture, resulting in injury.

6. Prohibit installing the unit at the place where there may be leaked corrosive gas or flammable gas.

If there leaked gas around the unit, it may cause explosion and other accidents.

7. Do not use extension cords for electrical connections. If the electric wire is not long enough, please contact a local service center authorized and ask for a proper electric wire.

Poor connections may lead to electric shock or fire.

8. Use the specified types of wires for electrical connections between the indoor and outdoor units. Firmly clamp the wires so that their terminals receive no external stresses.

Electric wires with insufficient capacity, wrong wire connections and insecure wire terminals may cause electric shock or fire.

7. Notes for Installation and Maintenance



R32 refrigerant warning

- To realize the function of the air conditioner unit, a special refrigerant circulates in the system. The used refrigerant is the fluoride R32, which is specially cleaned. The refrigerant is flammable and inodorous. Furthermore, it can lead to explosion under certain conditions. But the flammability of the refrigerant is very low. It can be ignited only by fire.
- Compared to common refrigerants, R32 is a nonpolluting refrigerant with no harm to the ozoneosphere. The influence upon the greenhouse effect is also lower. R32 has got very good thermodynamic features which lead to a really high energy efficiency. The units there fore need a less filling.
- This product uses R32 difluoromethane refrigerant, which is a mildly flammable gas class A2L according to ISO 817 or ANSI/ASHRAE 34.
- "ANSI/ASHRAE 15 (USA) and CSA 852 (Canada)" stipulate that it must be handled by a refrigeration mechanic with an appropriate refrigerant handling licence.
- The appliance shall be stored in a room without continuously operating ignition sources. (for example: open flames, an operating gas appliance or an operating electric heater.)
- The appliance shall be stored in a well-ventilated area where the room size corresponds to the room area as specified for operation.
- The appliance shall be stored so as to prevent mechanical damage from occurring.
- Ducts connected to an appliance shall not contain an ignition source.
- Keep any required ventilation openings clear of obstruction.
- Do not pierce or burn.
- Be aware that refrigerants may not contain an odour.
- Do not use means to accelerate the defrosting process or to clean, other than those recommended by the manufacturer.
- Servicing shall be performed only as recommended by the manufacturer.
- Should repair be necessary, contact your nearest authorized Service Centre. Any repairs carried out by unqualified personnel may be dangerous.

- Compliance with national gas regulations shall be observed. Read specialist's manual.



- That pipe-work including piping material, pipe routing, and installation shall include protection from physical damage in operation and service, and be in compliance with national and local codes and standards, such as ASHRAE 15, ASHRAE15.2, IAPMO Uniform Mechanical Code, ICC International Mechanical Code, or CSA B52. All field joints shall be accessible for inspection prior to being covered or enclosed.

Notices for using refrigerant sensor

- Only applicable to refrigerant sensor models.
- The refrigerant sensor can monitor whether R32 refrigerant leaks in real time. When the leakage of R32 refrigerant is detected, the sensor will trigger the alarm and emit a buzzer, and the indoor unit will display "EA" code. Meanwhile, the outdoor unit will stop running.
- In case of refrigerant leakage, please open the window immediately for ventilation to reduce the concentration of refrigerant in the room. Meanwhile, check the room to ensure that there is no fire source. After completing the above operations, please leave the room and go to the safe place, and then contact the after-sales service team for maintenance.
- When the refrigerant sensor reaches its service life or is damaged, the indoor unit will display "FE" code. Please contact the after-sales service team to replace the refrigerant sensor.
- Avoid oil and water splashing into the refrigerant sensor, otherwise it may cause damage to the refrigerant sensor. Avoid using it in the environment with electromagnetic interference, chemical substances (such as chemical plants, etc.), flammable gas, combustible and explosive gas and smog, etc.
- Avoid using items containing ethanol (such as perfume, etc.) and smogproducing items (such as cigarettes, etc.) near the refrigerant sensor, otherwise it will lead

7. Notes for Installation and Maintenance

to abnormal conditions such as false alarms of the refrigerant sensor. If such phenomenon occurs, please contact the after-sales service team for maintenance.

Safety Operation of Flammable Refrigerant

Aptitude requirement for maintenance man (repairs should be done only by specialists).

- Any person who is involved with working on or breaking into a refrigerant circuit should hold a current valid certificate from an industry-accredited assessment authority, which authorizes their competence to handle refrigerants safely in accordance with an industry recognized assessment specification.
- Servicing shall only be performed as recommended by the equipment manufacturer. Maintenance and repair requiring the assistance of other skilled personnel shall be carried out under the supervision of the person competent in the use of flammable refrigerants.

Safety preparation work

This product uses mildly flammable R32 refrigerant. Certain levels of refrigerant require minimum room sizes. Please ensure that these minimum room sizes are adhered to for standard installations. (Note: Please refer to the nameplate for the charging quantity of R32).

Appliance shall be installed, operated and stored in a room with a floor area larger than Xm^2 . (Please refer to table "a")

table a - Minimum room area (m^2)

Charge amount (kg)	Height of ventilation opening (m)				
	0.6	1.8	2.2	2.5	3
	Minimum room area (m^2)				
≤1.836	/	/	/	/	/
1.85	29.39	6.72	5.50	4.84	4.04
1.9	31.01	6.90	5.65	4.97	4.14
1.95	32.66	7.09	5.80	5.10	4.25
2	34.35	7.27	5.95	5.23	4.36
2.05	36.09	7.45	6.10	5.36	4.47
2.1	37.87	7.63	6.24	5.50	4.58
2.15	39.70	7.81	6.39	5.63	4.69
2.2	41.57	7.99	6.54	5.76	4.80
2.3	45.43	8.36	6.84	6.02	5.02
2.4	49.47	8.72	7.14	6.28	5.23
2.5	53.68	9.08	7.43	6.54	5.45
2.6	58.05	9.45	7.73	6.80	5.67

Charge amount (kg)	Height of ventilation opening (m)				
	0.6	1.8	2.2	2.5	3
	Minimum room area (m^2)				
2.7	62.61	9.81	8.03	7.06	5.89
2.8	67.33	10.17	8.32	7.33	6.11
2.9	72.22	10.54	8.62	7.59	6.32
3	77.29	10.90	8.92	7.85	6.54
3.1	82.53	11.26	9.21	8.11	6.76
3.2	87.94	11.62	9.51	8.37	6.98
3.3	93.52	11.99	9.81	8.63	7.19
3.4	99.27	12.35	10.11	8.89	7.41
3.5	105.20	12.71	10.40	9.16	7.63

Information on servicing

• Checks to the area

Prior to beginning work on systems containing FLAMMABLE REFRIGERANTS, Safety checks are necessary to ensure that the risk of ignition is minimised. For repair to the REFRIGERATING SYSTEM, the following precautions shall be completed prior to conducting work on the system.

• Work procedure

Work shall be undertaken under a controlled procedure so as to minimise the risk of a flammable gas or vapour being present while the work is being performed.

• General work area

All maintenance staff and others working in the local area shall be instructed on the nature of work being carried out. Work in confined spaces shall be avoided.

• Checking for presence of refrigerant

The area shall be checked with an appropriate refrigerant detector prior to and during work, to ensure the technician is aware of potentially toxic or flammable atmospheres. Ensure that the leak detection equipment being used is suitable for use with all applicable refrigerants, i.e. non-sparking, adequately sealed or intrinsically safe.

• Presence of fire extinguisher

If any hot work is to be conducted on the refrigerating equipment or any associated parts, appropriate fire extinguishing equipment shall be available to hand. Have a dry powder or CO₂ fire extinguisher adjacent to the charging area.

• No ignition sources

7. Notes for Installation and Maintenance

No person carrying out work in relation to a REFRIGERATING SYSTEM which involves exposing any pipe work shall use any sources of ignition in such a manner that it may lead to the risk of fire or explosion. All possible ignition sources, including cigarette smoking, should be kept sufficiently far away from the site of installation, repairing, removing and disposal, during which refrigerant can possibly be released to the surrounding space. Prior to work taking place, the area around the equipment is to be surveyed to make sure that there are no flammable hazards or ignition risks. "No Smoking" signs shall be displayed.

• Ventilated area

Ensure that the area is in the open or that it is adequately ventilated before breaking into the system or conducting any hot work. A degree of ventilation shall continue during the period that the work is carried out. The ventilation should safely disperse any released refrigerant and preferably expel it externally into the atmosphere.

• Checks to the refrigerating equipment

Where electrical components are being changed, they shall be fit for the purpose and to the correct specification. At all times the manufacturer's maintenance and service guidelines shall be followed. If in doubt, consult the manufacturer's technical department for assistance.

The following checks shall be applied to installations using FLAMMABLE REFRIGERANTS:

- *the actual REFRIGERANT CHARGE is in accordance with the room size within which the refrigerant containing parts are installed.*
- *the ventilation machinery and outlets are operating adequately and are not obstructed;*
- *if an indirect refrigerating circuit is being used, the secondary circuit shall be checked for the presence of refrigerant;*
- *marking to the equipment continues to be visible and legible. Markings and signs that are illegible shall be corrected.*
- *refrigerating pipe or components are installed in a position where they are unlikely to be exposed to any substance which may corrode refrigerant containing components, unless the components are constructed of materials which are inherently resistant to being corroded or are suitably protected against being so corroded.*

• Checks to electrical devices

Repair and maintenance to electrical components shall include initial safety checks and component inspection procedures. If a fault exists that could compromise safety, then no electrical supply shall be connected to the circuit until it is satisfactorily

dealt with. If the fault cannot be corrected immediately but it is necessary to continue operation, an adequate temporary solution shall be used. This shall be reported to the owner of the equipment so all parties are advised.

Initial safety checks shall include:

- that capacitors are discharged: this shall be done in a safe manner to avoid possibility of sparking;
- that no live electrical components and wiring are exposed while charging, recovering or purging the system;
- that there is continuity of earth bonding.

• Repairs to sealed components

Sealed electrical components shall be replaced.

• Repair to intrinsically safe components

Intrinsically safe components must be replaced.

• Cabling

Check that cabling will not be subject to wear, corrosion, excessive pressure, vibration, sharp edges or any other adverse environmental effects. The check shall also take into account the effects of aging or continual vibration from sources such as compressors or fans.

• Detection of flammable refrigerants

Under no circumstances shall potential sources of ignition be used in the searching for or detection of refrigerant leaks. A halide torch (or any other detector using a naked flame) shall not be used.

The following leak detection methods are deemed acceptable for all refrigerant systems.

Electronic leak detectors may be used to detect refrigerant leaks but, in the case of FLAMMABLE REFRIGERANTS, the sensitivity may not be adequate, or may need re-calibration. (Detection equipment shall be calibrated in a refrigerant-free area.) Ensure that the detector is not a potential source of ignition and is suitable for the refrigerant used. Leak detection equipment shall be set at a percentage of the LFL of the refrigerant and shall be calibrated to the refrigerant employed, and the appropriate percentage of gas (25% maximum) is confirmed.

Leak detection fluids are also suitable for use with most refrigerants but the use of detergents containing chlorine shall be avoided as the chlorine may react with the refrigerant and corrode the copper pipe-work.

NOTE Examples of leak detection fluids are

- bubble method,

7. Notes for Installation and Maintenance

- fluorescent method agents.

If a leak is suspected, all naked flames shall be removed/ extinguished.

If a leakage of refrigerant is found which requires brazing, all of the refrigerant shall be recovered from the system, or isolated (by means of shut off valves) in a part of the system remote from the leak. Removal of refrigerant shall be according to Clause "Removal and evacuation".

● Removal and evacuation

When breaking into the refrigerant circuit to make repairs - or for any other purpose - conventional procedures shall be used. However, for FLAMMABLE REFRIGERANTS it is important that best practice be followed, since flammability is a consideration. The following procedure shall be adhered to:

- Safely remove refrigerant following local and national regulations;
- evacuate;
- purge the circuit with inert gas (optional for A2L);
- evacuate (optional for A2L);
- continuously flush or purge with inert gas when using flame to open circuit; and
- open the circuit.

The REFRIGERANT CHARGE shall be recovered into the correct recovery cylinders if venting is not allowed by local and national codes. For appliances containing FLAMMABLE REFRIGERANTS, the system shall be purged with oxygen-free nitrogen to render the appliance safe for FLAMMABLE REFRIGERANTS. This process might need to be repeated several times. Compressed air or oxygen shall not be used for purging refrigerant systems.

For appliances containing FLAMMABLE REFRIGERANTS, REFRIGERANTS purging shall be achieved by breaking the vacuum in the system with oxygen-free nitrogen and continuing to fill until the working pressure is achieved, then venting to atmosphere, and finally pulling down to a vacuum (optional for A2L). This process shall be repeated until no refrigerant is within the system (optional for A2L). When the final oxygen-free nitrogen charge is used, the system shall be vented down to atmospheric pressure to enable work to take place.

The outlet for the vacuum pump shall not be close to any POTENTIAL IGNITION SOURCES, and ventilation shall be available.

● Charging procedures

In addition to conventional charging procedures, the following requirements shall be followed.

- Ensure that contamination of different refrigerants does not occur when using charging equipment. Hoses or lines shall be as short as possible to minimise the amount of refrigerant contained in them.
- Cylinders shall be kept in an appropriate position according to the instructions.
- Ensure that the REFRIGERATING SYSTEM is earthed prior to charging the system with refrigerant.
- Label the system when charging is complete (if not already).
- Extreme care shall be taken not to overfill the REFRIGERATING SYSTEM.

Prior to recharging the system, it shall be pressure-tested with the appropriate purging gas. The system shall be leak-tested on completion of charging but prior to commissioning. A follow up leak test shall be carried out prior to leaving the site.

● Decommissioning

Before carrying out this procedure, it is essential that the technician is completely familiar with the equipment and all its detail. It is recommended good practice that all refrigerants are recovered safely. Prior to the task being carried out, an oil and refrigerant sample shall be taken in case analysis is required prior to re-use of recovered refrigerant. It is essential that electrical power is available before the task is commenced.

- a) Become familiar with the equipment and its operation.
- b) Isolate system electrically
- c) Before attempting the procedure, ensure that:
 - mechanical handling equipment is available, if required, for handling refrigerant cylinders;
 - all personal protective equipment is available and being used correctly;
 - the recovery process is supervised at all times by a competent person;
 - recovery equipment and cylinders conform to the appropriate standards.
- d) Pump down refrigerant system, if possible.
- e) If a vacuum is not possible, make a manifold so that refrigerant can be removed from various parts of the system.
- f) Make sure that cylinder is situated on the scales before recovery takes place.
- g) Start the recovery machine and operate in accordance with instructions
- h) Do not overfill cylinders (no more than 80% volume liquid charge).

7. Notes for Installation and Maintenance

- i) Do not exceed the maximum working pressure of the cylinder even temporarily.
- j) When the cylinders have been filled correctly and the process completed, make sure that the cylinders and the equipment are removed from site promptly and all isolation valves on the equipment are closed off.
- k) Recovered refrigerant shall not be charged into another REFRIGERATING SYSTEM unless it has been cleaned and checked.

• Labelling

Equipment shall be labelled stating that it has been decommissioned and emptied of refrigerant. The label shall be dated and signed. For appliances containing FLAMMABLE REFRIGERANTS, ensure that there are labels on the equipment stating the equipment contains FLAMMABLE REFRIGERANT.

• Recovery

When removing refrigerant from a system, either for servicing or decommissioning, it is recommended good practice that all refrigerants are removed safely.

When transferring refrigerant into cylinders, ensure that only appropriate refrigerant recovery cylinders are employed. Ensure

that the correct number of cylinders for holding the total system charge is available. All cylinders to be used are designated for the recovered refrigerant and labelled for that refrigerant (i.e. special cylinders for the recovery of refrigerant). Cylinders shall be complete with pressure-relief valve and associated shut-off valves in good working order. Empty recovery cylinders are evacuated and, if possible cooled before recovery occurs.

The recovery equipment shall be in good working order with a set of instructions concerning the equipment that is at hand and shall be suitable for the recovery of the flammable refrigerant. If in doubt, the manufacturer should be consulted. In addition, a set of calibrated weighing scales shall be available and in good working order. Hoses shall be complete with leak-free disconnect couplings and in good condition.

The recovered refrigerant shall be processed according to local legislation in the correct recovery cylinder, and the relevant waste transfer note arranged. Do not mix refrigerants in recovery units and especially not in cylinders.

If compressors or compressor oils are to be removed, ensure that they have been evacuated to an acceptable level to make certain that flammable refrigerant does not remain within the lubricant. The compressor body shall not be heated by an open flame or other ignition sources to accelerate this process. When oil is drained from a system, it shall be carried out safely.

7. Notes for Installation and Maintenance

Main Tools for Installation and Maintenance



Level meter



Measuring tape



Screw driver



Impact drill



Drill head



Electric drill



Electroprobe



Universal meter



Torque wrench



Open-end wrench



Inner hexagon spanner



Electronic leakage detector



Vacuum pump



Pressure meter



Pipe pliers



Pipe pliers



Pipe cutter



Pipe expander



Pipe bender



Soldering appliance



Refrigerant container



Electronic scale

8. Installation

8.1 Names of Key Components

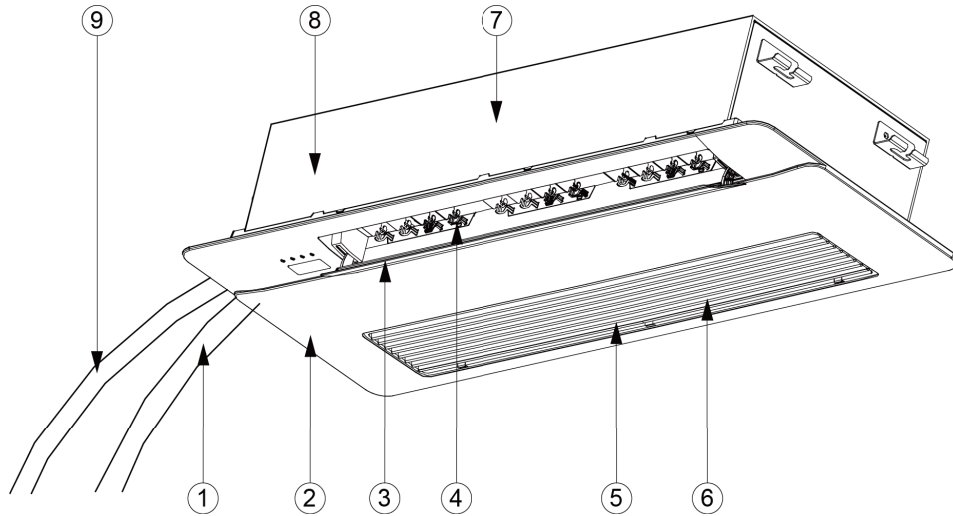

No.	1	2	3	4	5
Name	Connection pipe	Panel	Air louver	Swing blade	Air-in grille
No.	6	7	8	9	-
Name	Built-in filter	Main body	Drainage device (built-in)	Drainage Pipe	-

8.2 Rated Working Condition

Test condition	Indoor Side Condition		Outdoor Side Condition	
	Dry Bulb Temp °C(°F)	Wet Bulb Temp °C(°F)	Dry Bulb Temp °C(°F)	Wet Bulb Temp °C(°F)
Rated Cooling	27(81)	19(66)	35(95)	24(75)
Rated Heating	20(68)	15(59)	7(45)	6(43)

8. Installation

8.3 Preparative for Installation

NOTE!

This picture is for reference only, please refer to the actual product, the unit of dimension is mm.

8.3.1 Installation Position Selection

1. The appliance shall not be installed in the laundry.
2. The location should be able to withstand the weight of unit.
3. The water can be drained conveniently from drainage pipe.
4. There should be no obstruction near air inlet and air outlet.
5. Follow the installation distance required in the fig below to ensure sufficient space for maintenance.
6. The installation location should be far from heat sources, flammable or explosive gas, or smog spread in the air.
7. The indoor unit, outdoor unit, power cord and connection electricity wire should be at least 1m from television and radio in order to prevent interference and noise. (Even though 1m distance is ensure, there may be noise if the electric wave is too strong.)

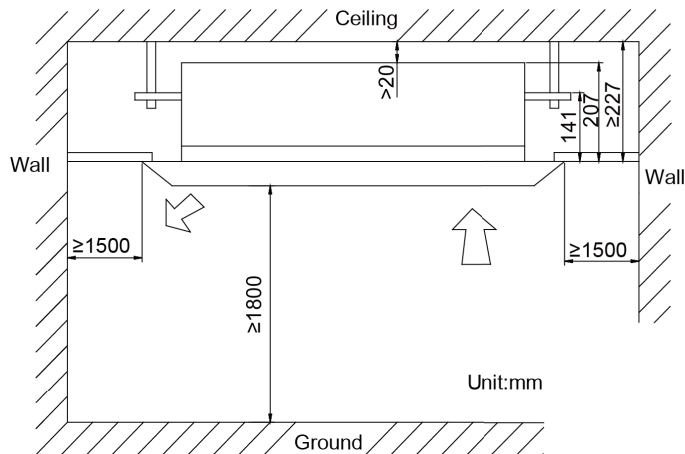

Fig 3.1

NOTE!

1. The unit shall be installed in accordance with national standards or local regulations.
2. Only qualified personnel can carry out installation work, please contact with local dealer before installation.
3. Make sure all the installation work completed before energizing.

8.2.2 Wiring Requirement

Dimension of power cord.

Model	Minimum Sectional Area of Power Cord (mm ²)
09K, 12K, 18K, 20K	4 × AWG14

NOTE!

1. An all-pole disconnection switch having a contact separation of at least 3mm in all poles should be connected in fixed wiring.
2. The power cord specification in above sheet is based on ambient temperature of 40°C.

8.4 Installation Instructions

8.4.1 Indoor Unit Installation

Ceiling Opening Dimension and Suspension Bolt Position

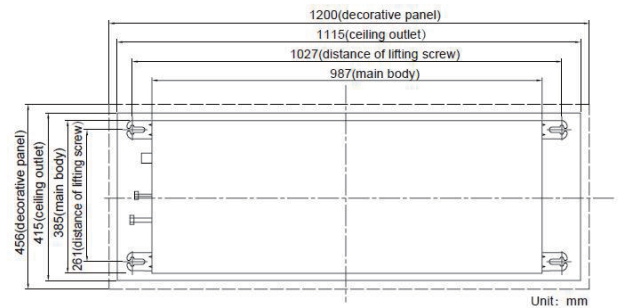

Fig 4.1.1

Suspend the Indoor Unit

1. Drill bolt holes and install bolts
 - (1) Stick the reference cardboard on the installation position; drill 4 holes according to the hole site on the cardboard as shown in fig 4.1.2; diameter of drilling hole is according to the diameter of expansion bolt and the depth is 60-70mm, as shown in fig 4.1.3.

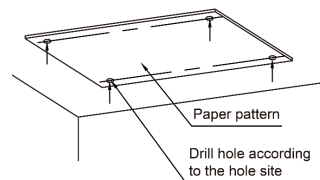

Fig 4.1.2

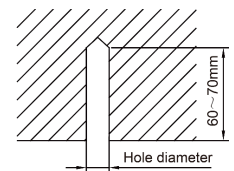

Fig 4.1.3

- (2) Insert the M10 expansion bolt into the hole and then knock the nail into the bolt, as shown in fig 4.1.4.

NOTE!

The length of bolt depends on the installation height of the unit, bolts are field supplied.

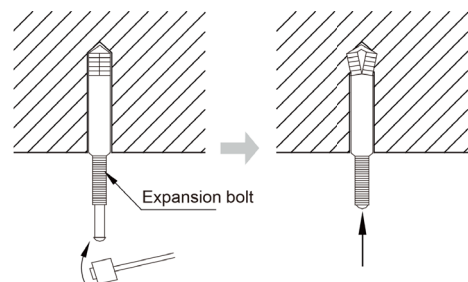

Fig 4.1.4

8. Installation

2. Install the indoor unit temporarily.

Assemble suspension bolt on the expansion bolt, attach the hanger bracket to the suspension bolt. Be sure to fix it securely by using a nut and washer from upper and lower sides of the hanger bracket. The washer fixing plate will prevent the washer from falling.

3. The usage of paper pattern.

Refer to paper pattern of installation for ceiling opening dimension. The center of ceiling opening is indicated on the paper pattern. Fix the paper pattern to the unit with 4 screws and fix the corners of the waterspout at the drainage pipe by screws.

4. Adjust the unit to the right position.

5. Check the level of the unit

The indoor unit is equipped with build-in water pump and float switch, verify the levelness of 4 directions by level gauge or vinyl tube (filled with water) respectively.

6. Remove the washer locating plate and then tighten the nut on it.

7. Remove the paper pattern.

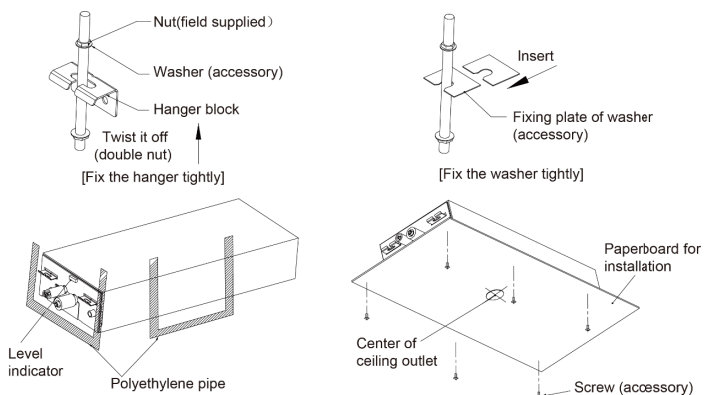

Fig 4.1.5

NOTE!

1. Drilling of ceiling opening and installation of air conditioner must be performed by professionals!
2. Please refer to the installation cardboard for the dimension of drilling hole of lifting screw of cassette unit.

8.4.2 Refrigerant Pipe Connection

1. Aim the flaring port of copper pipe at the center of screwed joint and then tighten the flaring nut with hand as shown in fig 4.2.
2. Tighten the flaring nut with torque wrench.

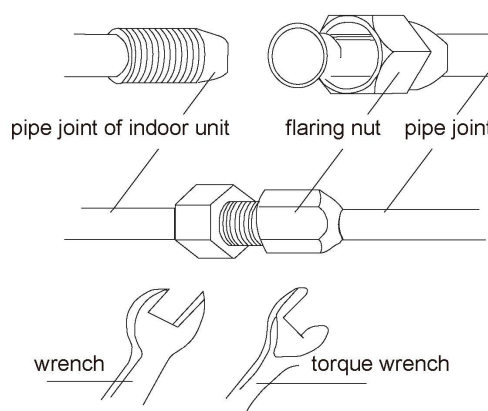

Fig 4.2

Pipe Diameter (inch)	Tightening torque (N·m)
1/4	15~20
3/8	30~40
1/2	45~55
5/8	60~65

3. Use pipe bend when bending the pipe and the bending angle should not be too small.
4. Wrap the connection pipe and joint with sponge and then tie them firmly with tape.

8.4.3 Drainage Pipe Installation and Drainage System Testing

Notice for Installation of Drain Pipe

1. It is not allowed to connect the condensate drain pipe into waste pipe or other pipelines which are likely to produce corrosive or peculiar smell to prevent the smell from entering indoors or corrupt the unit.
2. It is not allowed to connect the condensate drain pipe into rain pipe to prevent rain water from pouring in and cause property loss or personal injury.
3. Condensate drain pipe should be connected into special drain system for air conditioner.
4. The drainage pipe should be short and the gradient downwards should be at least 1%~2% in order to drain condensation water smoothly.
5. The diameter of drainage hose should be bigger or equal to the diameter of drainage pipe joint.
6. Install drainage pipe according to the following fig and arrange insulation to the drainage pipe. Improper installation may lead to water leakage and damp the furniture and other things in the room.
7. You can buy normal hard PVC pipe used as the drainage pipe. During connection, insert the end of PVC pipe into the drainage hole and then tighten it with drainage hole and wire

8. Installation

binder. Can't connect the drainage hole and drainage hole with glue.

- When the drainage pipelines are used for several units, the position of pipeline should be about 100mm lower than the drainage port of each unit. In this case, thicker pipes should be applied.

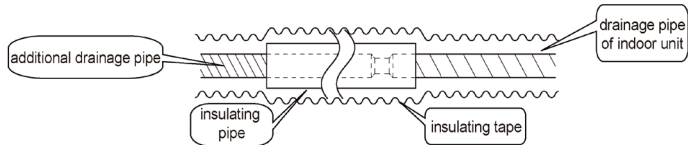

Fig 4.3.1

Drainage Pipe Installation

- Drainage pipe should have the same diameter or larger diameter than the connecting pipes (PVC pipe, outside diameter 25mm, thickness \geq 1.5mm).
- Keep drainage pipe short and sloping downwards at a gradient of at least 1% for preventing forming air bubbles.
- If the gradient of drainage pipe could not meet the installation requirements, raising pipe should be applied.
- Insert the drainage hose into drain socket, tighten the metal clamp securely.
- Warp the sealing pad over drain hose and metal clamp for heat insulation.
- Make sure to perform insulation work for all drainage piping in order to prevent any possible water drop due to dew condensation.
- Apply the suitable diameter for converging drainage pipe according to the operating capacity of the unit.

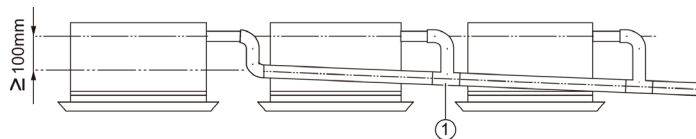

Fig 4.3.2

① drainage pipes assembled by T-shaped joints

- The installation height of raising pipe for drainage should be lower than B. The gradient from raising pipe towards drainage direction should be at least 1%~2%. If the raising pipe is vertical with the unit, the raising height should be less than C.

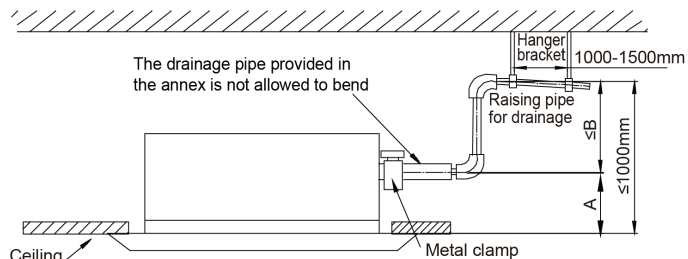

Fig 4.3.3

Model	A(mm)	B(mm)	C(mm)
09K, 12K, 18K, 20K	100	900	850

- Drain pipes should have a downward slope of at least 1%~2%, in order to prevent pipes from sagging, install hanger bracket at intervals of 1000~1500mm.

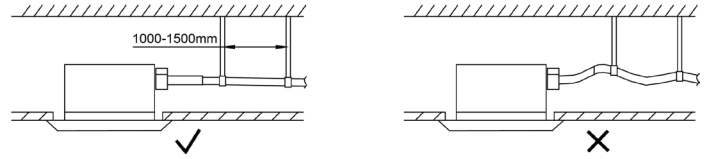

Fig 4.3.4

8.4.4 Wiring Precautions

⚠ WARNING!

- Before obtaining access to terminals, all supply circuits must be disconnected.
- The rated voltage of the unit is as shown as Table 1. wiring could cause malfunction or even damage the unit.
- Before turning on, verify that the voltage is within the 198~264V range(for single phase unit) or 342~457V range (for three-phase unit).
- Always use a special branch circuit and install a special receptacle to supply power to the air conditioner.
- The special branch circuit breaker is installed in the permanent wiring. Always use a circuit that can trip all the poles of the wiring and has an isolation distance of at least 3mm between the contacts of each pole.
- Perform wiring work in accordance with standards so that the air conditioner can be operated safely and positively.
- Install a leakage special branch circuit breaker in accordance with the related laws and regulations and electric company standards.

⚠ CAUTION!

- The power source capacity must be the sum of the air conditioner current and the current of other electrical appliances. When the current contracted capacity is insufficient, change the contracted capacity.
- When the voltage is low and the air conditioner is difficult to start, contact the power company to raise the voltage.

Connection of Wire and Patch Board Terminal

- The connection of wire (as shown in fig 4.4.1)
 - Strip about 25mm insulation of the wire end by stripping and cutting tool.
 - Remove the wiring screws on the terminal board.
 - Shape the tail of wire into ring by needle nose plier, and keep the gauge of ring in accordance with screw.

8. Installation

- (4) Use the screwdriver for tightening the terminal.
2. The connection of stranded wire (as shown in fig 4.4.2)
 - (1) Strip about 10mm insulation of the end of stranded wire by stripping and cutting tool.
 - (2) Loosen the wiring screws on terminal board.
 - (3) Insert the wire into the ring tongue terminal and tighten by crimping tool.
 - (4) Use the screwdriver for tightening the terminal.

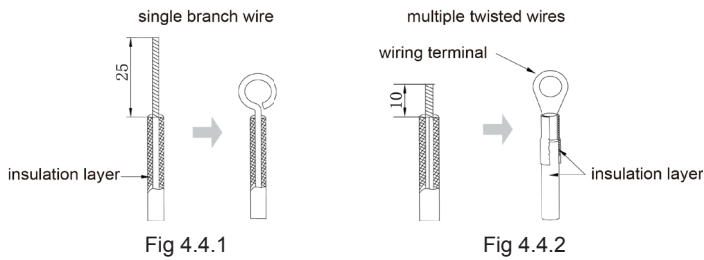

4. Ground both the indoor and outdoor units by attaching a ground wire.
5. Unit shall be grounded in compliance with the applicable local and national codes.

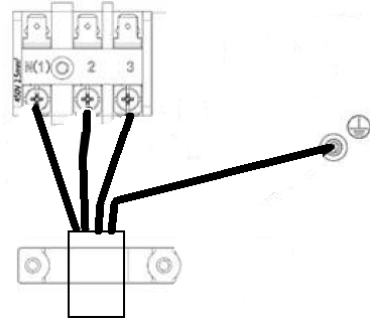

8.4.5 Panel Installation

Notices for Installation

1. Improper decorative panel installation could cause the following problems.

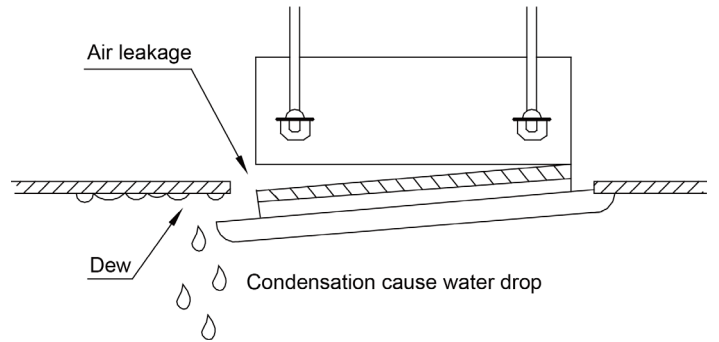

Fig 4.5.1

2. Ensure that it's clearance-free between decoration panels and ceiling board after installation, if not, please adjust the body position.

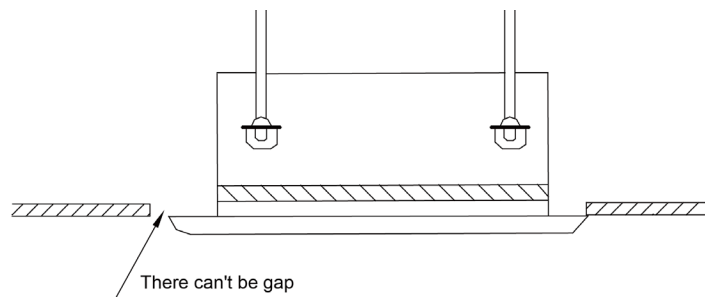

Fig 4.5.2

3. Connect the decoration panel terminals (Female) to body terminals (male) as shown in figure 4.5.3.

⚠ WARNING!

1. Before starting work, check that power is not being supplied to the indoor unit and outdoor unit.
2. Match the terminal block numbers and connection cord colors with those of the indoor unit side.
3. Erroneous wiring may cause burning of the electric parts.
4. Connect the connection cords firmly to the terminal block. Imperfect installation may cause a fire.
5. Always fasten the outside covering of the connection cord with cord clamps. (If the insulator is not clamped, electric leakage may occur.)
6. Always connect the ground wire.

3. Electric wiring between the indoor and outdoor units

Single-phase units(09K~20K)

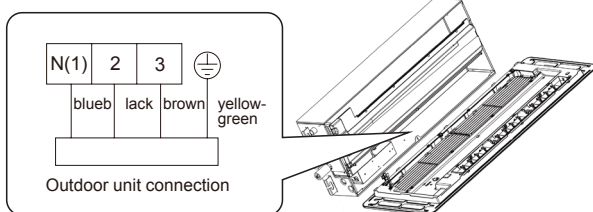

4. Electric wiring of indoor unit side

Remove the electric box cover from the electric box sub-assy and then connect the wire.

⚠ CAUTION!

1. Tighten the power cord respectively on the terminal boards with screws. Faulty connection may cause a fire.
2. If the power supply are wired incorrectly, the air conditioner may be damaged.
3. Connect the indoor unit connection cord properly based on the corresponding marks as shown in fig 5.1.5.

8. Installation

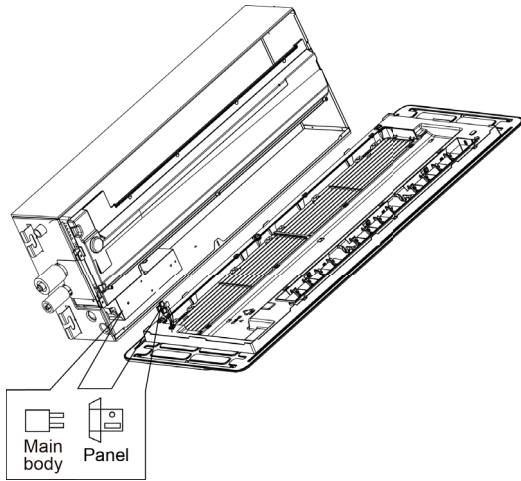

Fig 4.5.3

Panel Installation

1. Remove the grille from the panel, and then open the horizontal louver.
2. Aim the screw hole on panel at the corresponding screw hole on main unit.
3. Screw up the screws on corresponding holes and then install the corresponding screw cover.
4. Close the horizon louver, connect the butt terminal and arrange the wires.
5. Install the grille.

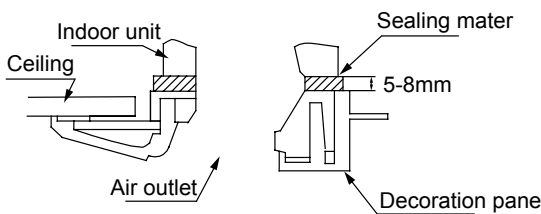
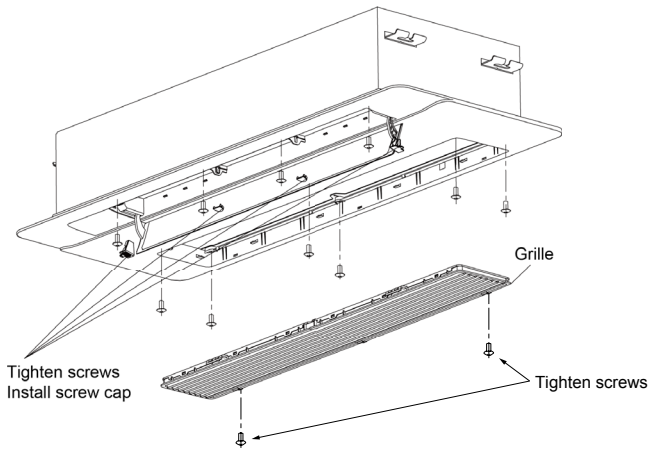

Fig 4.5.4

Test of Drainage System

1. Please test drainage system after electric work is finished.
Inject approximately 1L purified water to drain pan from air

vent, ensure that not to splash the water over the electrical components (e.g. water pump. etc.).

- (1) In case of commissioning finished, please energize the IDUs and switch to cooling or dry mode, meanwhile, the water pump operates, you can check the draining through the transparent part of drain socket.
 - (2) If communication wire is not connected, communication malfunction "E6" will occur after 180s of energizing. In this case, the water pump operates automatically. Check if the water pump drains normally through drainage port. The water pump will stop automatically after running for 1min.
2. During the test, please carefully check the drainage joint; make sure no any leakage occur.
 3. It's strongly recommend to do the drain test before ceiling decoration.

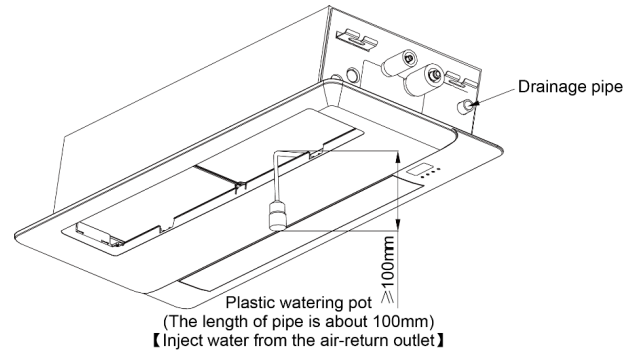

Fig 4.5.5

8.4.6 Installation of Wired Controller

Connection of the Signal Line of the Wired Controller

- Open the cover of the electric control box of the indoor unit.
- Let the single line of the wired controller through the soleplate of wired controller.
- Connect the signal line of the wired controller to the 4-pin socket of the indoor unit.
- The communication distance between the main board and the wired controller can be up to 20 meters (the standard distance is 8 meters)

Installation of the Wired Controller

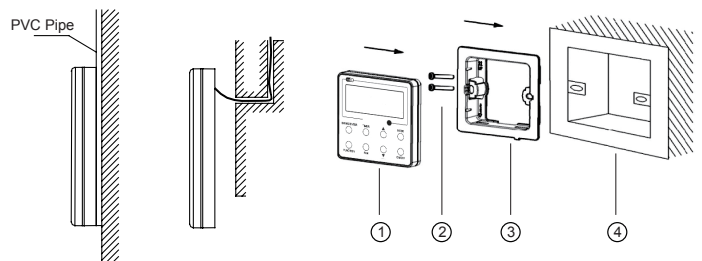

Fig. 4.6.1 Accessories for the Installation of the Wired Controller

8. Installation

Table 3

No.	1	2	3	4
Name	Front Panel of the Wired Controller	Screw M4X25	Soleplate of the Wired Controller	Controller embedded in the wall

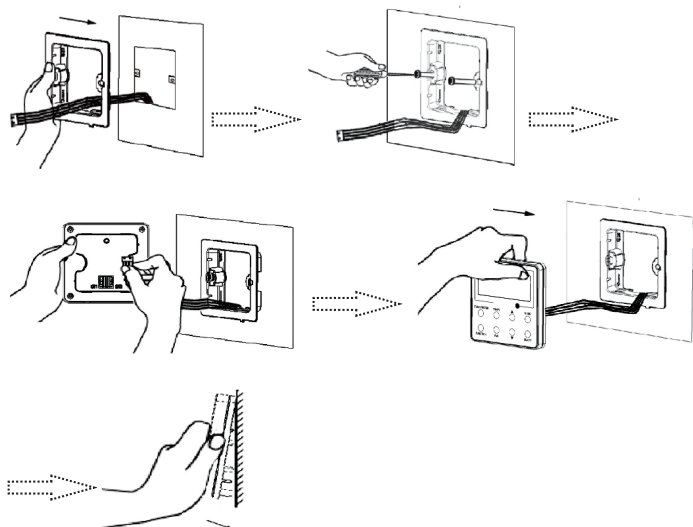

Fig. 4.6.2

NOTE:

CN1 is 485 communication interface and it used Wired Controller XE72-44/E for connecting the 4-core communication wire. These two needle stands (CN2, CN3) are used for connecting the smart zone controller. There is no sequence for these two needle stands. You can connect one or two needle stand(s) basing on the requirement.

Fig. 4.6.2 shows the installation steps of the wired controller, but there are some issues that need your attention.

- (1) Prior to the installation, please firstly cut off the power supply of the wire buried in the installation hole, that is, no operation is allowed with electricity during the whole installation.
- (2) Pull out the four-core twisted pair line from the installation holes and then let it go through the rectangular hole behind the soleplate of the wired controller.
- (3) Stick the soleplate of wired controller on the wall and then use screw M4x25 to fix soleplate and installation hole on wall together.
- (4) Insert the four-core twisted pair line into the slot of the wired controller and then buckle the front panel and the soleplate of the wired controller together.

For matching with different models, the patch cord and the connection wire are provided in the packaging box of wired controller. As shown in Fig. 4.6.3.

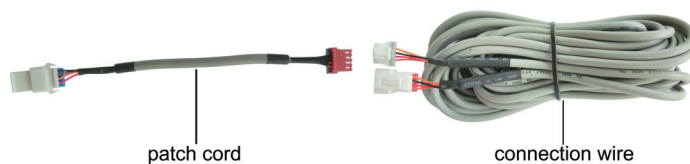

Fig. 4.6.3: Schematic diagram of patch cord and connection wire

- If the air conditioner has been installed with the patch cord (Fig. 4.6.3) used for connecting the wired controller.

Only use the connection wire (Fig. 4.6.4) in the packing box of wired controller. Connect the terminal ② to the terminal ④ of patch cord which has been installed on the air conditioner; insert terminal ① to needle stand CN1 of wired controller. If there's protection terminal ③, pull out the protection terminal at first and then install it.

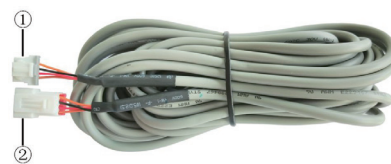

Fig. 4.6.4: Schematic diagram of connection wire: Connect terminal ① with wired controller CN1; connect terminal ② with the terminal ④ of patch cord

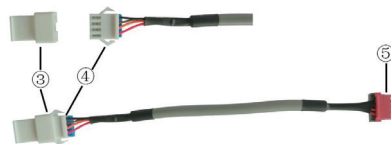

Fig. 4.6.5: Schematic diagram of patch cord: Terminal ③ is the protection terminal; connect terminal ④ to the terminal ② of connection wire; connect terminal ⑤ to the terminal of wired controller of air conditioner

- If the air conditioner hasn't been installed with the patch cord used for connecting the wired controller.

Use the connection wire and patch cord in the packing box of wired controller. Pull out the protection terminal of patch cord at first, connect the connection wire with the patch cord according to Fig. 4.6.6, and then insert the terminal ① of connection wire into the needle stand CN1 of wired controller and insert the terminal ⑤ of patch cord into the terminal of wired controller of air conditioner as well.

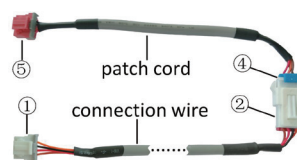

Fig. 4.6.6: Schematic diagram after the connection wire and the patch cord have been connected: connect the terminal ② of connection wire and the terminal ④ of patch cord

8. Installation

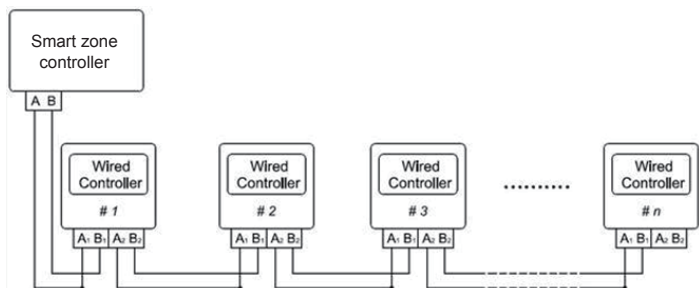

Fig. 4.6.7

Fig. 4.6.7 shows the schematic diagram of control system connection. XE72-44/E can connect the smart zone controller (integrated control system). “n” indicates the number of communication node address (programmable wired controller XE72-44/E). The complete system is composed of the smart zone controller, wired controller XE72-44/E and communication cable. The wired controller XE72-44/E can support 16 communication node addresses at the most ($n \leq 16$).

Terminal A and terminal B of the smart zone controller are respectively connected to the corresponding communication needle stand terminal of the #1 wired controller by the communication cable; the other needle stand of #1 wired controller is connected to the #2 wired controller through the telecommunication cable and so forth until connect to the #n wired controller. Except the last wired controller in the control system (only use CN2 or CN3, and the other one will not be connected), there's no the sequence and the importance for the wired controller. The series number in the figure is only for the sake of clarity.

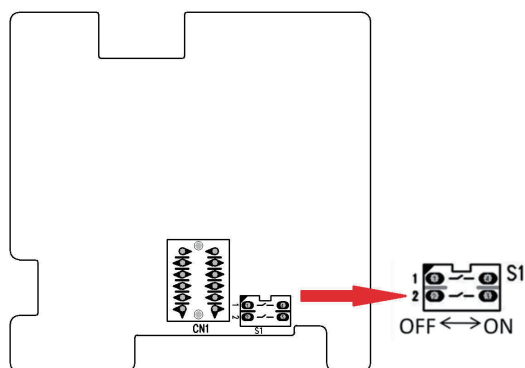

Fig. 4.6.8

Fig. 4.6.8 shows schematic diagram of DIP switch. There is a 2-bit DIP switch on the main board of wired controller XE72-44/E. As for the last #n wired controller in the control system, the 1-bit and the 2-bit of the DIP switch should be manually pulled to position “on” and position “off” respectively. The DIP switches of other wired controllers should be kept at the initial ex-factory status (1-bit and 2-bit are set at position “off”).

⚠ CAUTION!

Please pay special attention to the followings during the connection to avoid the malfunction of the air conditioning unit due to electromagnetic interference.

(1) Separate the signal and communication lines of the wired controller from the power cord and connection lines between the indoor and outdoor unit, with a minimum interval of 20cm, otherwise the communication of the unit will probably work abnormally.

(2) If the air conditioning unit is installed where is vulnerable to electromagnetic interference, then the signal and communication lines of the wired controller must be the shielding twisted pair lines.

Dismantlement of the Wired Controller

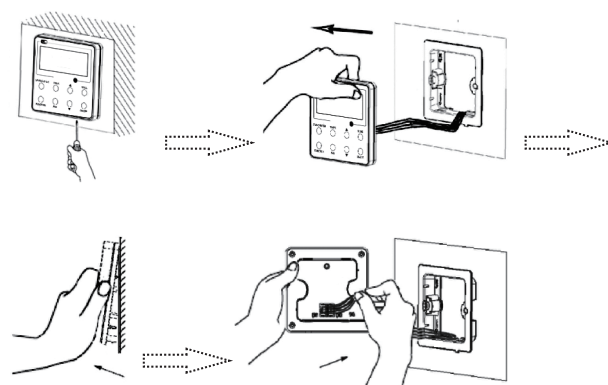

9. Maintenance

9.1 Error Code List

NO.	Name of malfunction	Indoor unit displaying method				AC status	Malfunctions
		Double 8 code display	Indicator display(LED blinks 0.5s-ON/0.5s-OFF)				
			Running LED	Cooling LED	Heating LED		
1	Indoor and outdoor units communication malfunction	E6	Off 3s blink 6 times			Cooling,compressor will stop,indoor fan motor works,Heating:all will stop	Please refer to troubleshooting
2	Indoor unit motor no feedback	H6	Off 3s blink 11 times			Whole unit will stop to run	1.Poor insert for GPF 2.Indoor control board AP1 malfunction 3.Indoor motor M1 malfunction
3	Jump wire cap malfunction protection	C5	Off 3s blink 15 times			Whole unit will stop to run	Indoor control board AP1 jump cap poor connected,please reinsert or replace the jump cap.
4	Indoor ambient sensor open circuit,short circuit	F1		Off 3s blink once		Cooling,dehumidifying:indoor fan motor is runing,other overloads will stop;Heating,whole unit will stop to run.	1.Room temp.sensor is not connected with the control panel AP1 2.Room temp.sensor is damaged
5	Indoor evaporator sensor circuit open,short circuit	F2		Off 3s blink twice		Cooling,dehumidifying;indoor fan motor runing,other overload will stop;Heating,whole unit will stop.	1,Tube temp.sensor is not connected with the control panel AP1 2.Tube temp.sensor is damaged
6	In defect of refrigerant	F0				The Dual-8 Code Display will show F0 and the complete unit stops.	1. In defect of refrigerant; 2. Indoor evaporator temperature sensor works abnormally; 3. The unit has been plugged up somewhere.
7	Full water protection	E9				Water level switch	If cut-off of water level switch is detected for 8s successively once energized, the system will enter full water protection. In this case, switch off the unit and then switch it on to eliminate this malfunction.

9. Maintenance

9.2 Procedure of Troubleshooting

1. Malfunction of Temperature Sensor F1, F2

Main detection points:

- Is the wiring terminal between the temperature sensor and the controller loosened or poorly contacted?
- Is there short circuit due to trip-over of the parts?
- Is the temperature sensor broken?
- Is mainboard broken?

Malfunction diagnosis process:

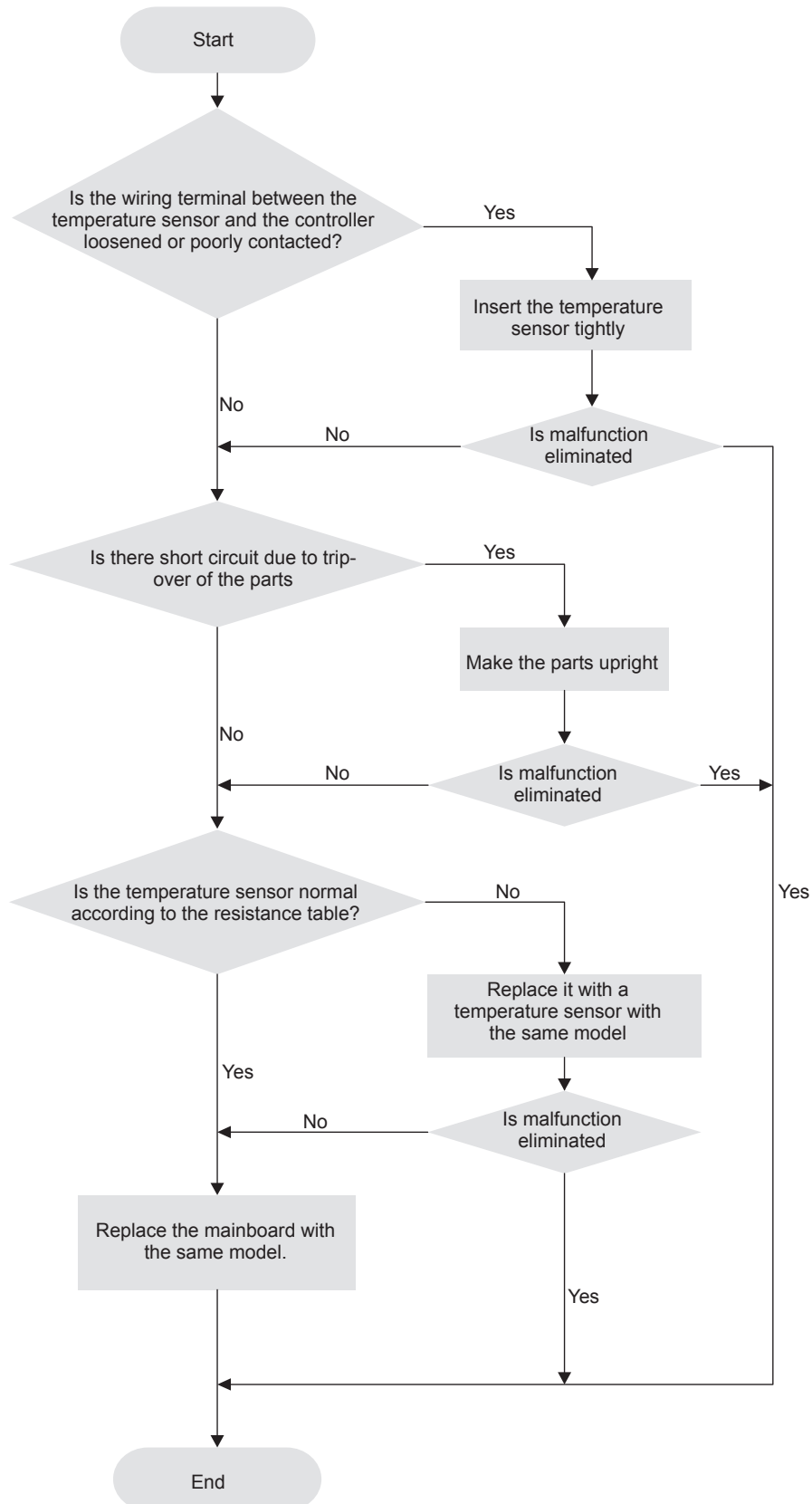

9. Maintenance

2. Malfunction of Blocked Protection of IDU Fan Motor H6

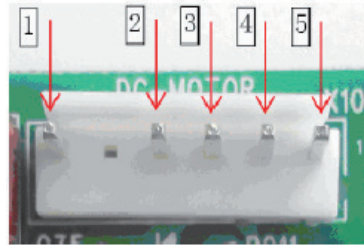
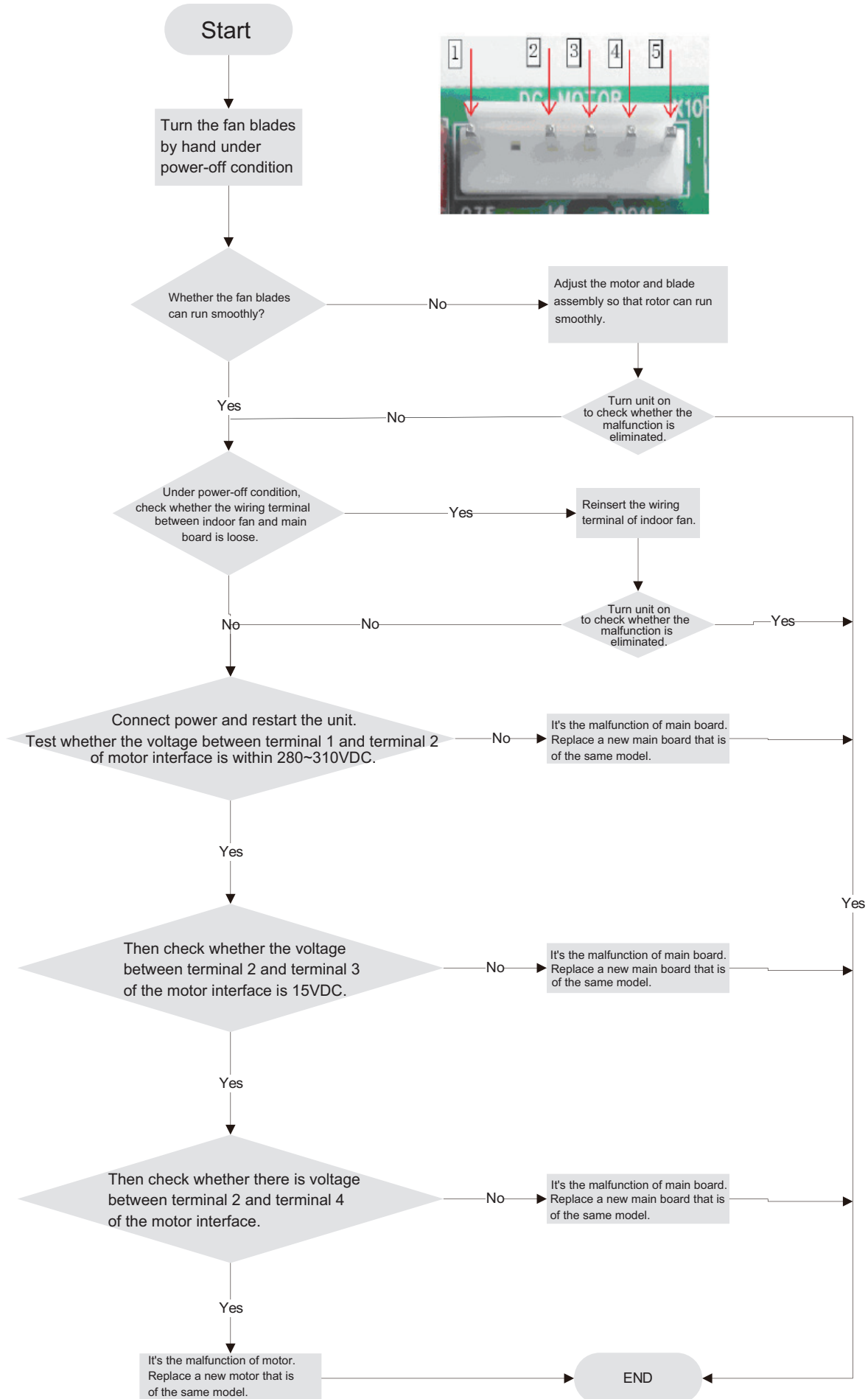

9. Maintenance

3. Malfunction of Protection of Jumper Cap C5

Main detection points:

- Is there jumper cap on the mainboard?
- Is the jumper cap inserted correctly and tightly?
- The jumper is broken?
- The motor is broken?
- Detection circuit of the mainboard is defined abnormal?

Malfunction diagnosis process:

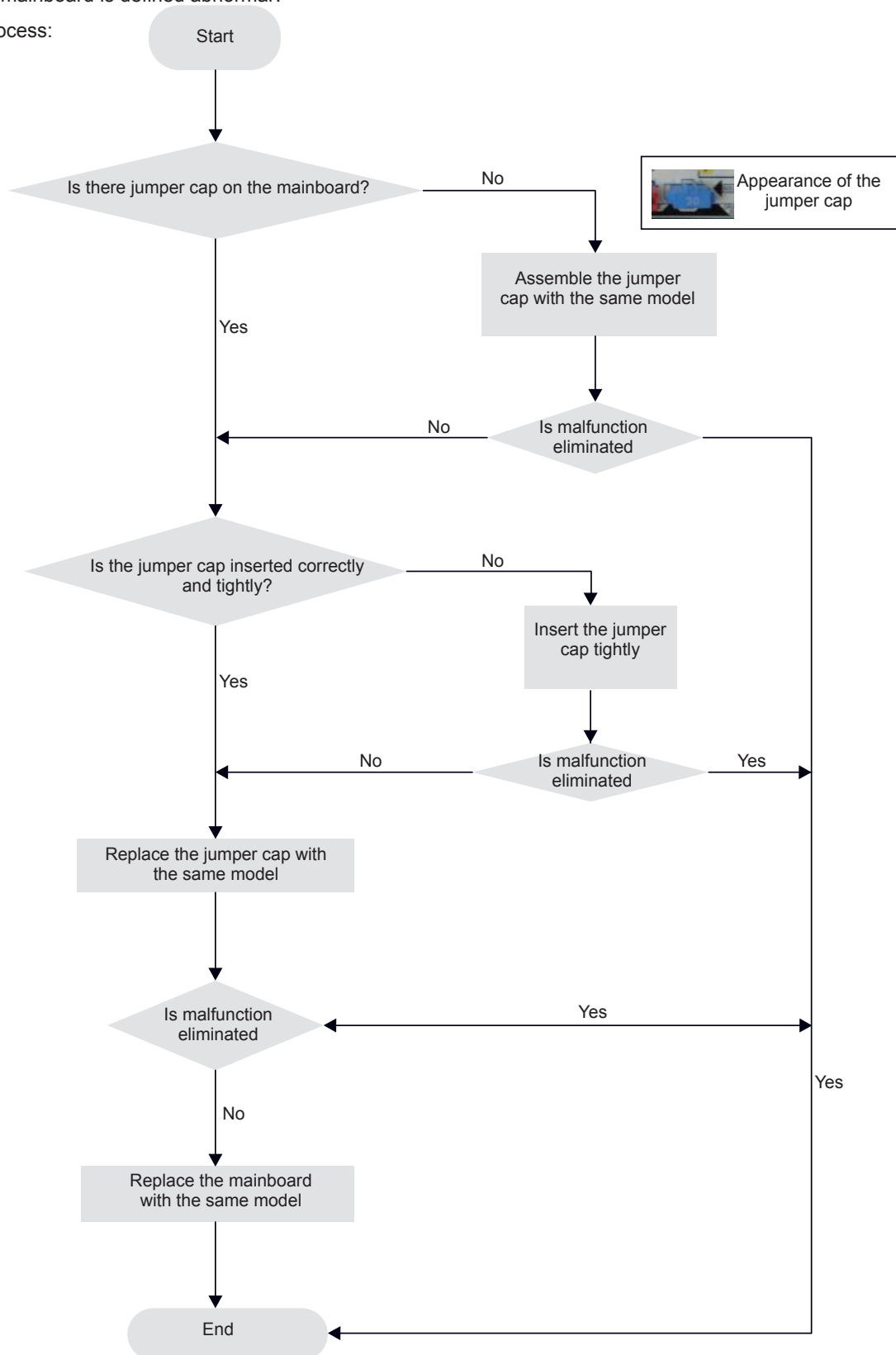

9. Maintenance

4. Communication malfunction E6

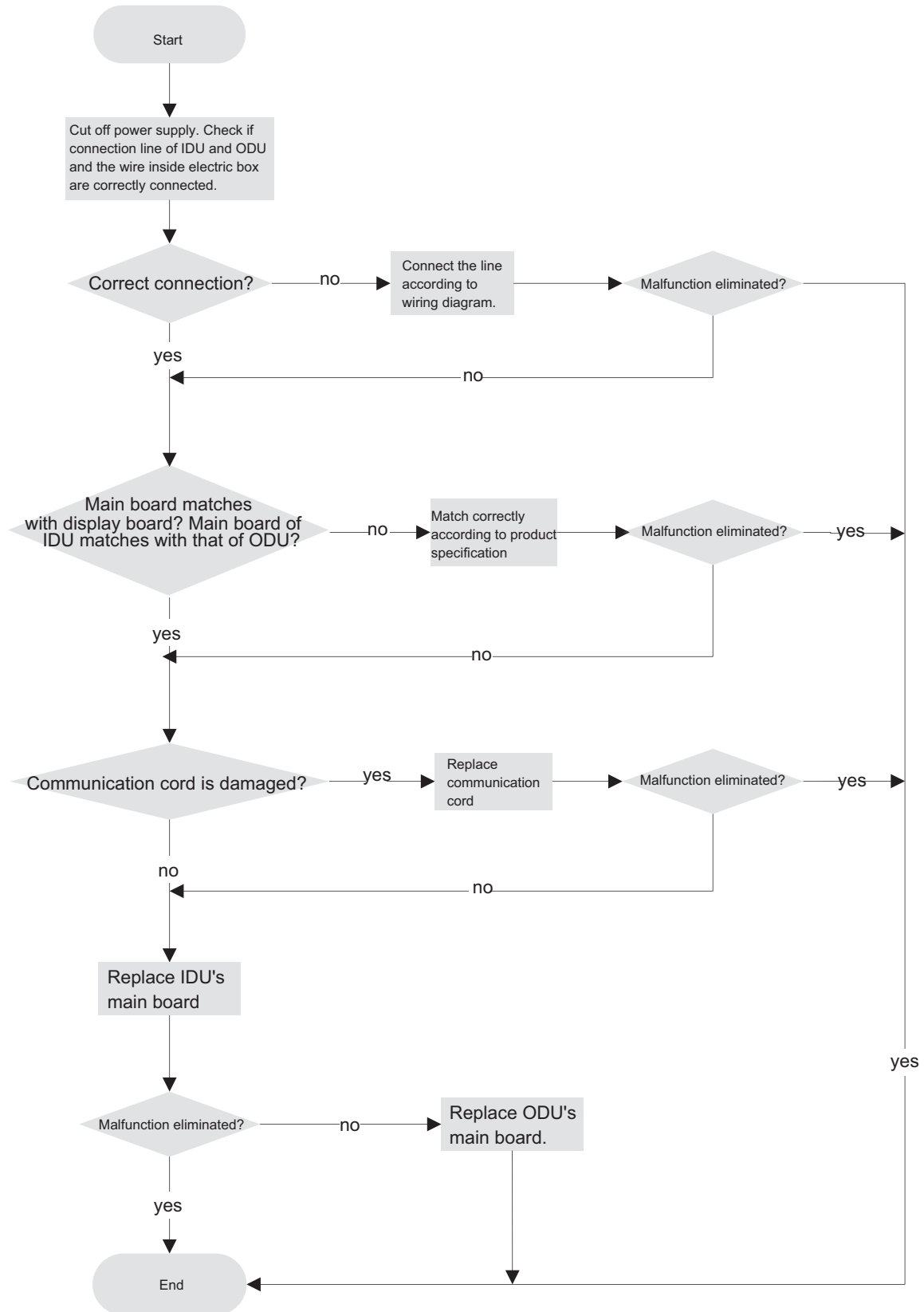

9. Maintenance

5. Malfunction of Insufficient fluorine protection F0

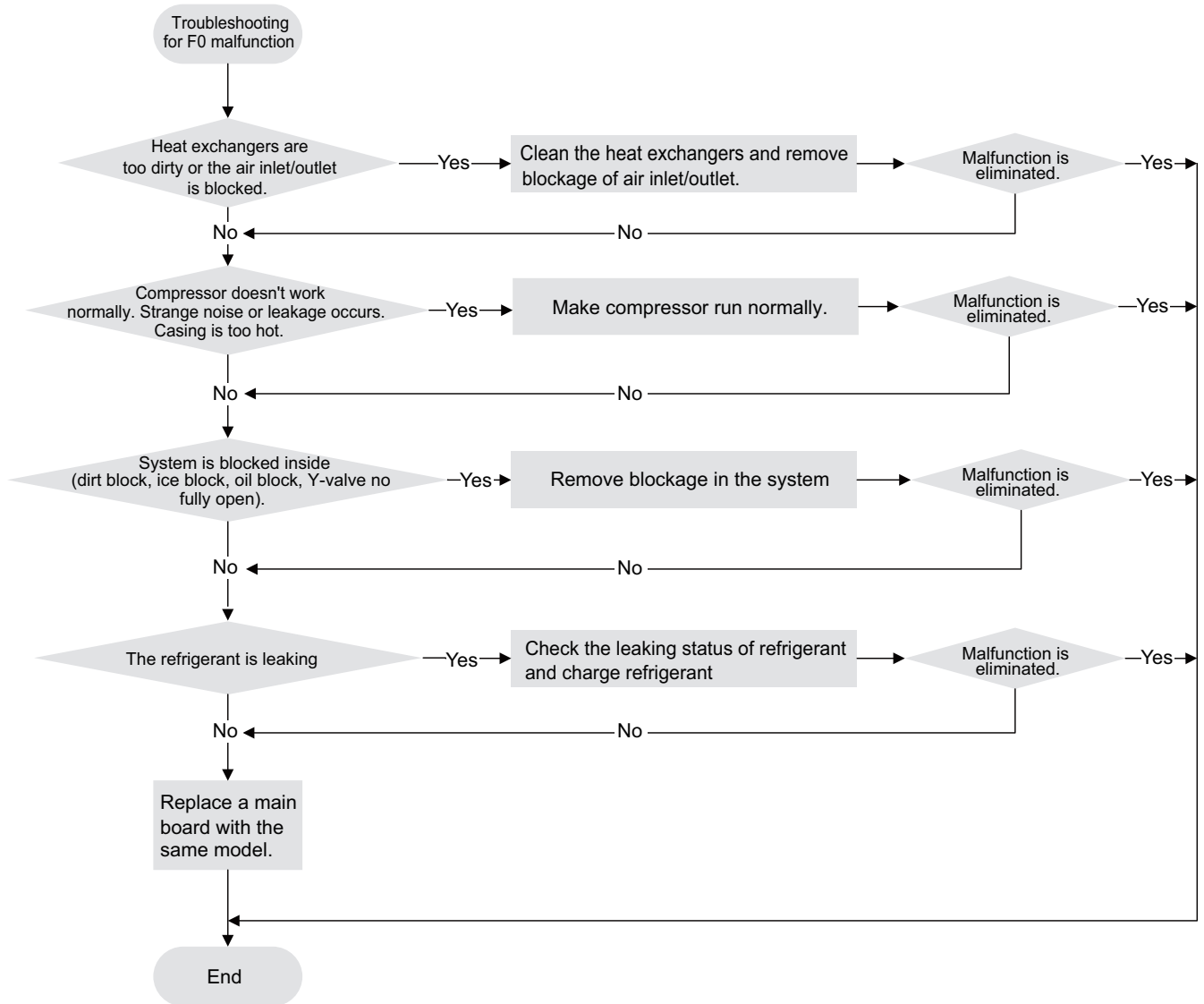

9. Maintenance

6. Full Water Protection E9

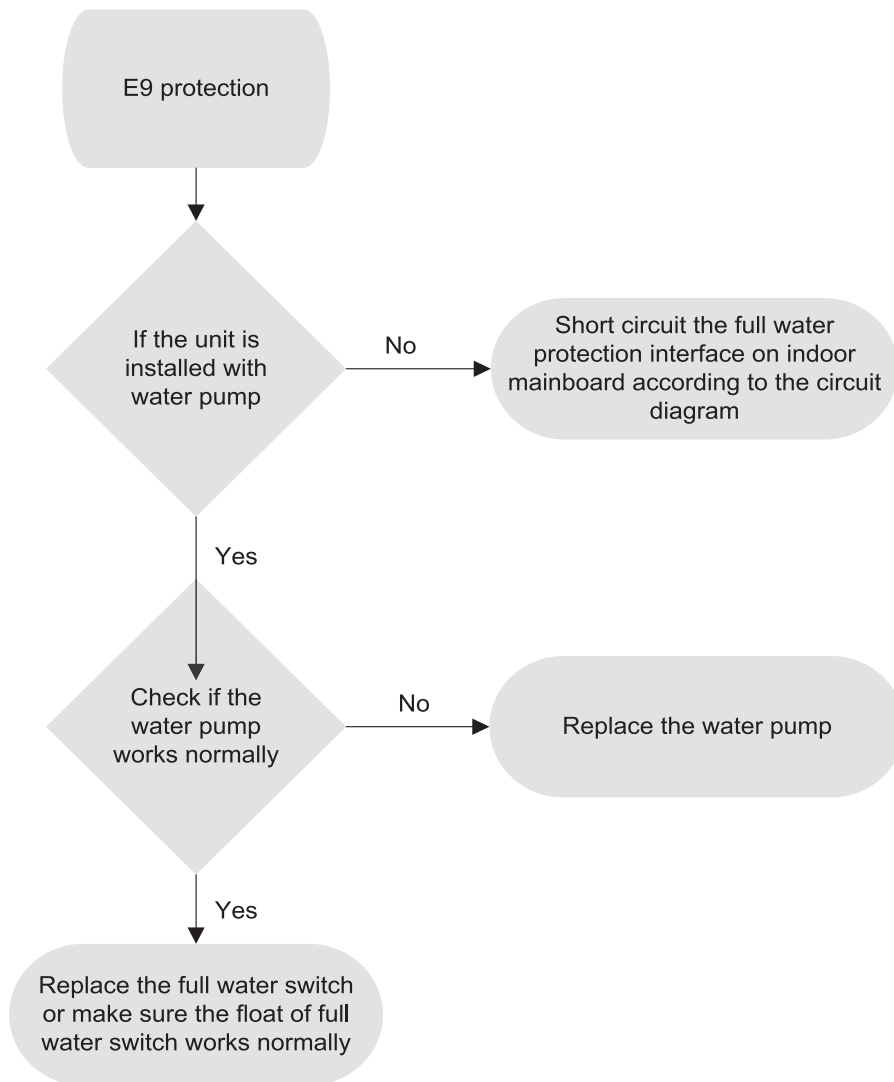

9. Maintenance

9.3 Troubleshooting for Normal Malfunction

1. Air Conditioner Can't be Started Up

Possible Causes	Discriminating Method (Air conditioner Status)	Troubleshooting
No power supply, or poor connection for power plug	After energization, operation indicator isn't bright and the buzzer can't give out sound	Confirm whether it's due to power failure. If yes, wait for power recovery. If not, check power supply circuit and make sure the power plug is connected well.
Wrong wire connection between indoor unit and outdoor unit, or poor connection for wiring terminals	Under normal power supply circumstances, operation indicator isn't bright after energization	Check the circuit according to circuit diagram and connect wires correctly. Make sure all wiring terminals are connected firmly
Electric leakage for air conditioner	After energization, room circuit breaker trips off at once	Make sure the air conditioner is grounded reliably Make sure wires of air conditioner are connected correctly Check the wiring inside air conditioner. Check whether the insulation layer of power cord is damaged; if yes, place the power cord.
Model selection for air switch is improper	After energization, air switch trips off	Select proper air switch
Malfunction of remote controller	After energization, operation indicator is bright, while no display on remote controller or buttons have no action.	Replace batteries for remote controller Repair or replace remote controller

2. Poor Cooling (Heating) for Air Conditioner

Possible Causes	Discriminating Method (Air conditioner Status)	Troubleshooting
Set temperature is improper	Observe the set temperature on remote controller	Adjust the set temperature
Rotation speed of the IDU fan motor is set too low	Small wind blow	Set the fan speed at high or medium
Filter of indoor unit is blocked	Check the filter to see if it's blocked	Clean the filter
Installation position for indoor unit and outdoor unit is improper	Check whether the installation position is proper according to installation requirement for air conditioner	Adjust the installation position, and install the rainproof and sunproof for outdoor unit
Refrigerant is leaking	Discharged air temperature during cooling is higher than normal discharged wind temperature; Discharged air temperature during heating is lower than normal discharged wind temperature; Units pressure is much lower than regulated range	Find out the leakage causes and deal with it. Add refrigerant.
Malfunction of 4-way valve	Blow cold wind during heating	Replace the 4-way valve
Malfunction of capillary	Discharged air temperature during cooling is higher than normal discharged wind temperature; Discharged air temperature during heating is lower than normal discharged wind temperature; Unit pressure is much lower than regulated range. If refrigerant isn't leaking, part of capillary is blocked	Replace the capillary
Flow volume of valve is insufficient	The pressure of valves is much lower than that stated in the specification	Open the valve completely
Malfunction of horizontal louver	Horizontal louver can't swing	Refer to point 3 of maintenance method for details
Malfunction of the IDU fan motor	The IDU fan motor can't operate	Refer to troubleshooting for H6 for maintenance method in details
Malfunction of the ODU fan motor	The ODU fan motor can't operate	Refer to point 4 of maintenance method for details
Malfunction of compressor	Compressor can't operate	Refer to point 5 of maintenance method for details

3. Horizontal Louver Can't Swing

Possible Causes	Discriminating Method (Air conditioner Status)	Troubleshooting
Wrong wire connection, or poor connection	Check the wiring status according to circuit diagram	Connect wires according to wiring diagram to make sure all wiring terminals are connected firmly
Stepping motor is damaged	Stepping motor can't operate	Repair or replace stepping motor
Main board is damaged	Others are all normal, while horizontal louver can't operate	Replace the main board with the same model

9. Maintenance

4. ODU Fan Motor Can't Operate

Possible causes	Discriminating method (air conditioner status)	Troubleshooting
Wrong wire connection, or poor connection	Check the wiring status according to circuit diagram	Connect wires according to wiring diagram to make sure all wiring terminals are connected firmly
Capacity of the ODU fan motor is damaged	Measure the capacity of fan capacitor with an universal meter and find that the capacity is out of the deviation range indicated on the nameplate of fan capacitor.	Replace the capacity of fan
Power voltage is a little low or high	Use universal meter to measure the power supply voltage. The voltage is a little high or low	Suggest to equip with voltage regulator
Motor of outdoor unit is damaged	When unit is on, cooling/heating performance is bad and ODU compressor generates a lot of noise and heat.	Change compressor oil and refrigerant. If no better, replace the compressor with a new one

5. Compressor Can't Operate

Possible causes	Discriminating method (air conditioner status)	Troubleshooting
Wrong wire connection, or poor connection	Check the wiring status according to circuit diagram	Connect wires according to wiring diagram to make sure all wiring terminals are connected firmly
Capacity of compressor is damaged	Measure the capacity of fan capacitor with an universal meter and find that the capacity is out of the deviation range indicated on the nameplate of fan capacitor.	Replace the compressor capacitor
Power voltage is a little low or high	Use universal meter to measure the power supply voltage. The voltage is a little high or low	Suggest to equip with voltage regulator
Coil of compressor is burnt out	Use universal meter to measure the resistance between compressor terminals and its 0	Repair or replace compressor
Cylinder of compressor is blocked	Compressor Can't operate	Repair or replace compressor

6. Air Conditioner is Leaking

Possible causes	Discriminating method (air conditioner status)	Troubleshooting
Drain pipe is blocked	Water leaking from indoor unit	Eliminate the foreign objects inside the drain pipe
Drain pipe is broken	Water leaking from drain pipe	Replace drain pipe
Wrapping is not tight	Water leaking from the pipe connection place of indoor unit	Wrap it again and bundle it tightly

7. Abnormal Sound and Vibration

Possible causes	Discriminating method (air conditioner status)	Troubleshooting
When turn on or turn off the unit, the panel and other parts will expand and theres abnormal sound	Theres the sound of "PAPA"	Normal phenomenon. Abnormal sound will disappear after a few minutes.
When turn on or turn off the unit, theres abnormal sound due to flow of refrigerant inside air conditioner	Water-running sound can be heard	Normal phenomenon. Abnormal sound will disappear after a few minutes.
Foreign objects inside the indoor unit or therere parts touching together inside the indoor unit	Theres abnormal sound fro indoor unit	Remove foreign objects. Adjust all parts position of indoor unit, tighten screws and stick damping plaster between connected parts
Foreign objects inside the outdoor unit or therere parts touching together inside the outdoor unit	Theres abnormal sound fro outdoor unit	Remove foreign objects. Adjust all parts position of outdoor unit, tighten screws and stick damping plaster between connected parts
Short circuit inside the magnetic coil	During heating, the way valve has abnormal electromagnetic sound	Replace magnetic coil
Abnormal shake of compressor	Outdoor unit gives out abnormal sound	Adjust the support foot mat of compressor, tighten the bolts
Abnormal sound inside the compressor	Abnormal sound inside the compressor	If add too much refrigerant during maintenance, please reduce refrigerant properly. Replace compressor for other circumstances.

10. Exploded View and Parts List

09K, 12K, 18K, 20K

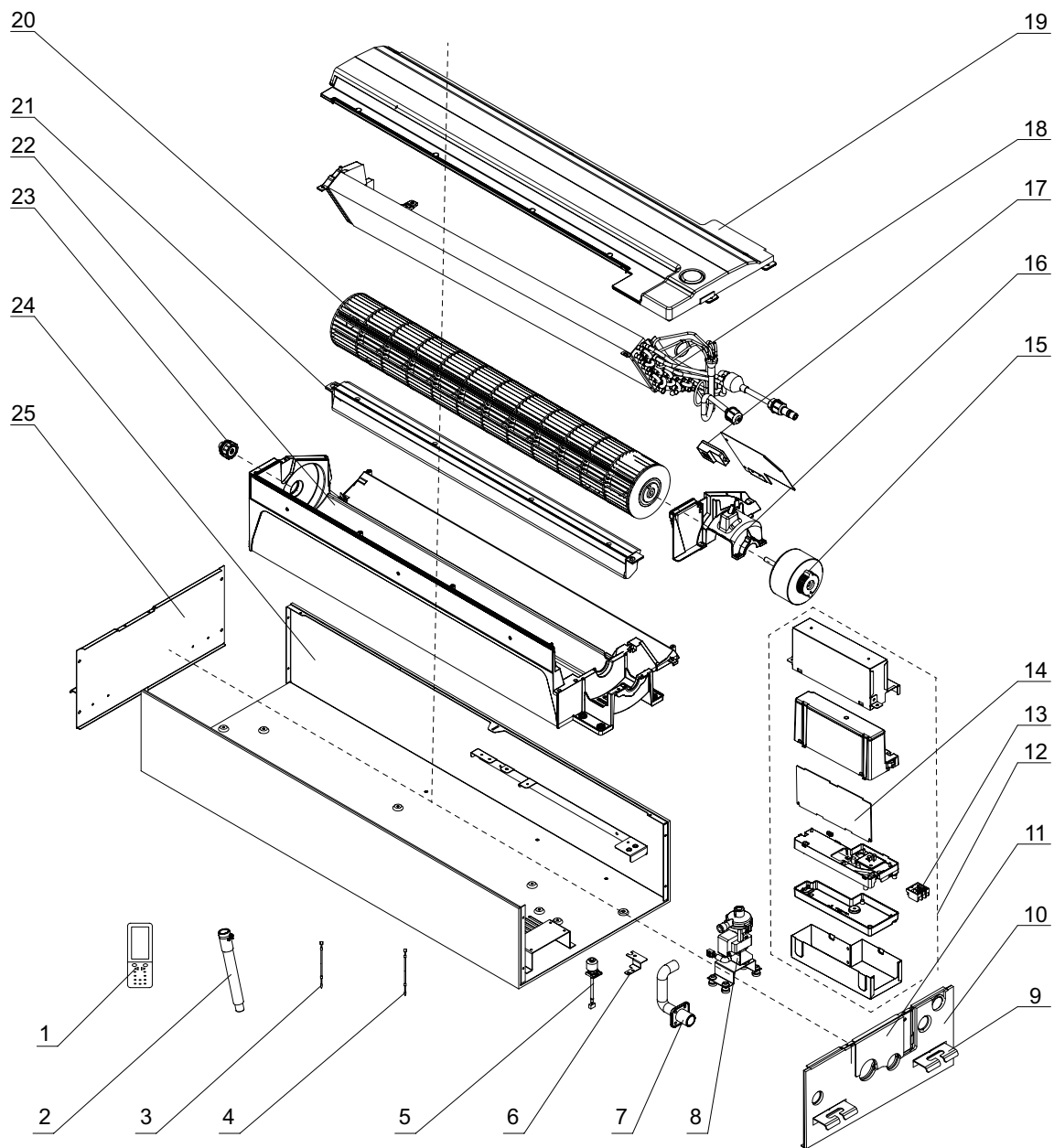

The component picture is only for reference; please refer to the actual product.

10. Exploded View and Parts List

NO.	Description	NO.	Description
1	Remote Controller	14	Main Board
2	Drain Hose Sub-assy	15	Brushless DC Motor
3	Temperature Sensor	16	Motor Press Plate
4	Temperature Sensor	17	Gas Sensor
5	Liquid Level Switch	18	Evaporator Assy
6	Support	19	Water Tray Sub-assy
7	Pump Drainpipe	20	Cross Flow Fan
8	Water Pump Assy	21	Helicoid Tongue Sub-assy
9	Hook	22	Base Frame Sub-assy
10	Right Side Plate Sub-assy	23	O-Gasket of Cross Fan Bearing
11	Tube Exit Plate Assy	24	Chassis Assy
12	Electric Box Assy	25	Left Side Plate Sub-assy
13	Terminal Board		

Some models may not contain some parts, please refer to the actual product.

11. Removal Procedure

! Caution: discharge the refrigerant completely before removal.

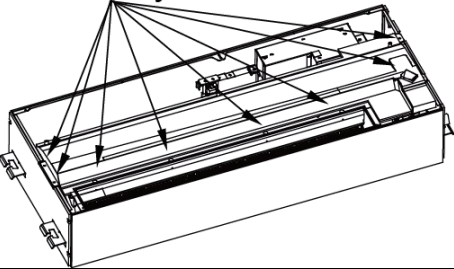
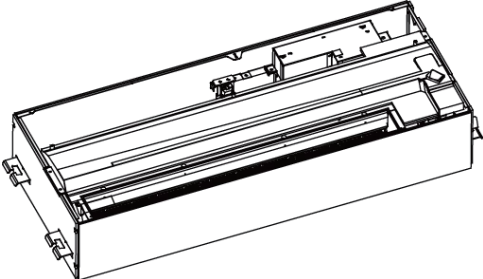
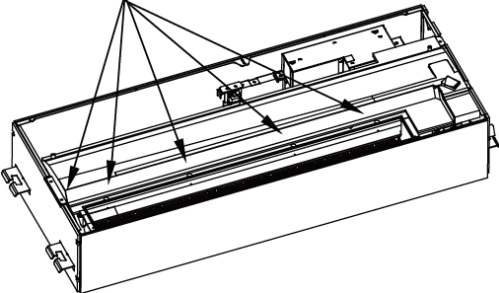
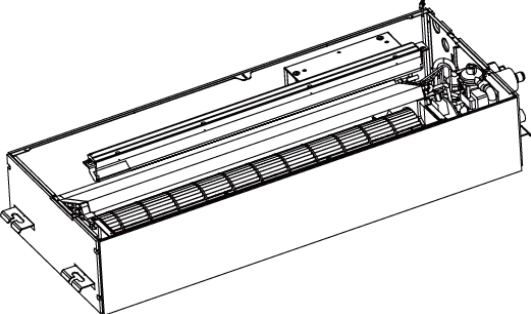
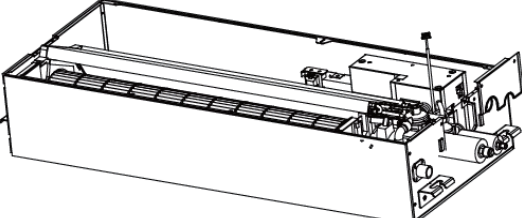
Motor and fan		
Step	Diagram	Operation Procedure
1. Unscrew the water tray.	<p>Unscrew the water tray</p> 	<ul style="list-style-type: none"> ● Use a screwdriver to unscrew the water tray.
2. Remove the water tray.		<ul style="list-style-type: none"> ● Remove the water tray.
3. Unscrew the volute tongue.	<p>Unscrew the volute</p> 	<ul style="list-style-type: none"> ● Use a screwdriver to unscrew the volute tongue.
4. Remove the volute tongue.		<ul style="list-style-type: none"> ● Remove the volute tongue.
5. Unscrew the outlet board.		<ul style="list-style-type: none"> ● Use a screwdriver to unscrew the outlet board and then remove the board.

11. Removal Procedure

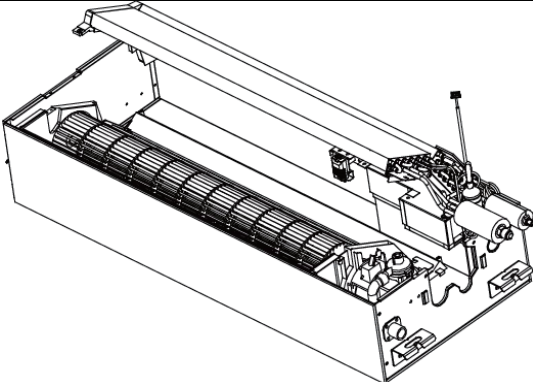
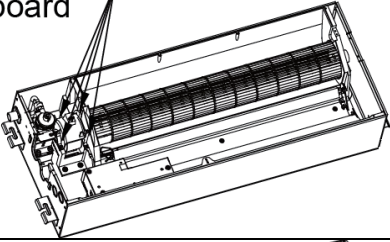
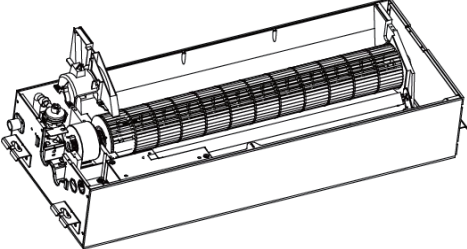
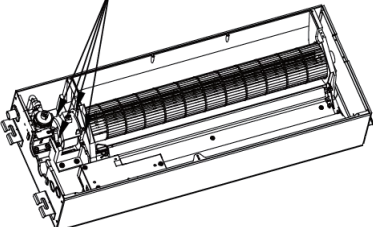
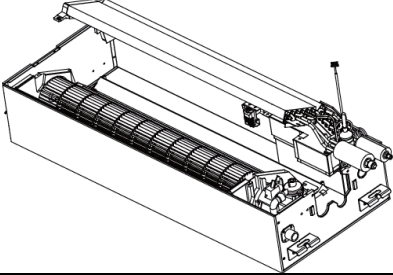
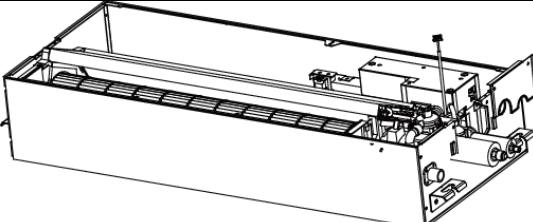
Motor and fan		
Step	Diagram	Operation Procedure
6. Remove the evaporator.		<ul style="list-style-type: none"> ● Remove the evaporator.
7. Unscrew the motor pressing board.	<p>Unscrew the motor pressing board</p> 	<ul style="list-style-type: none"> ● Use a screwdriver to unscrew the motor pressing board.
8. Remove the pressing board and replace the motor.		<ul style="list-style-type: none"> ● Remove the pressing board and replace the motor.
9. Screw the motor pressing board.	<p>Screw the motor pressing board</p> 	<ul style="list-style-type: none"> ● Use a screwdriver to screw the motor pressing board.
10. Install the evaporator.		<ul style="list-style-type: none"> ● Install the evaporator.
11. Screw the outlet board.		<ul style="list-style-type: none"> ● Use a screwdriver to screw the outlet board.

Appendix

Appendix 1: Reference Sheet of Celsius and Fahrenheit

Conversion formula for Fahrenheit degree and Celsius degree: $T_f = T_c \times 1.8 + 32$

Set temperature

Fahrenheit display temperature (°F)	Fahrenheit (°F)	Celsius (°C)	Fahrenheit display temperature (°F)	Fahrenheit (°F)	Celsius (°C)	Fahrenheit display temperature (°F)	Fahrenheit (°F)	Celsius (°C)
61	60.8	16	69/70	69.8	21	78/79	78.8	26
62/63	62.6	17	71/72	71.6	22	80/81	80.6	27
64/65	64.4	18	73/74	73.4	23	82/83	82.4	28
66/67	66.2	19	75/76	75.2	24	84/85	84.2	29
68	68	20	77	77	25	86	86	30

Ambient temperature

Fahrenheit display temperature (°F)	Fahrenheit (°F)	Celsius (°C)	Fahrenheit display temperature (°F)	Fahrenheit (°F)	Celsius (°C)	Fahrenheit display temperature (°F)	Fahrenheit (°F)	Celsius (°C)
32/33	32	0	55/56	55.4	13	79/80	78.8	26
34/35	33.8	1	57/58	57.2	14	81	80.6	27
36	35.6	2	59/60	59	15	82/83	82.4	28
37/38	37.4	3	61/62	60.8	16	84/85	84.2	29
39/40	39.2	4	63	62.6	17	86/87	86	30
41/42	41	5	64/65	64.4	18	88/89	87.8	31
43/44	42.8	6	66/67	66.2	19	90	89.6	32
45	44.6	7	68/69	68	20	91/92	91.4	33
46/47	46.4	8	70/71	69.8	21	93/94	93.2	34
48/49	48.2	9	72	71.6	22	95/96	95	35
50/51	50	10	73/74	73.4	23	97/98	96.8	36
52/53	51.8	11	75/76	75.2	24	99	98.6	37
54	53.6	12	77/78	77	25			

Appendix 2: Pipe Expanding Method

⚠ Note:

Improper pipe expanding is the main cause of refrigerant leakage. Please expand the pipe according to the following steps:

A: Cut the pipe

- Confirm the pipe length according to the distance of indoor unit and outdoor unit.
- Cut the required pipe with pipe cutter.

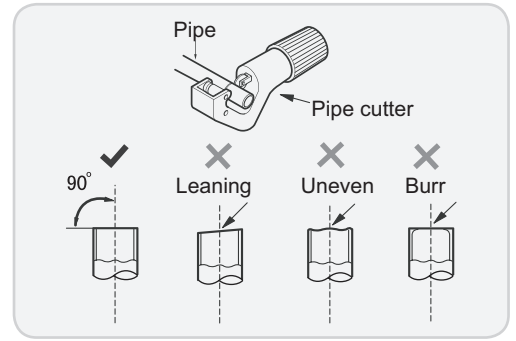

B: Remove the burrs

- Remove the burrs with shaper and prevent the burrs from getting into the pipe.

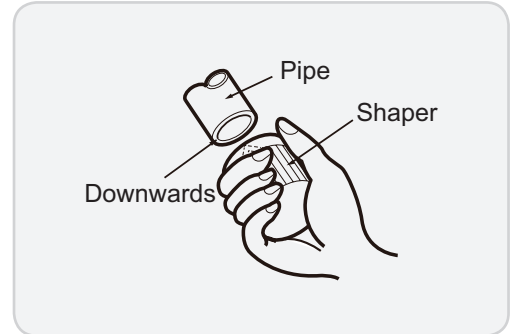

C: Put on suitable insulating pipe.

D: Put on the union nut

- Remove the union nut on the indoor connection pipe and outdoor valve; install the union nut on the pipe.

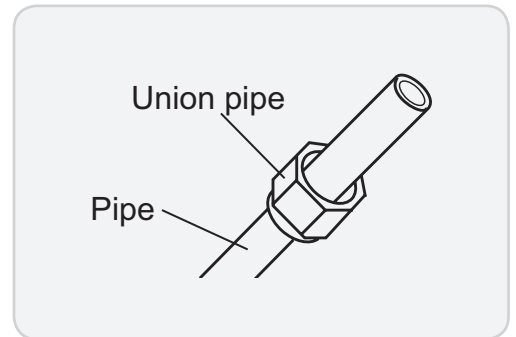

E: Expand the port

- Expand the port with expander.

⚠ Note:

- "A" is different according to the diameter, please refer to the sheet below:

Outer diameter(mm)	A(mm)	
	Max	Min
Φ6 - 6.35 (1/4")	1.3	0.7
Φ9.52 (3/8")	1.6	1.0
Φ12 - 12.70 (1/2")	1.8	1.0
Φ16 - 15.88 (5/8")	2.4	2.2

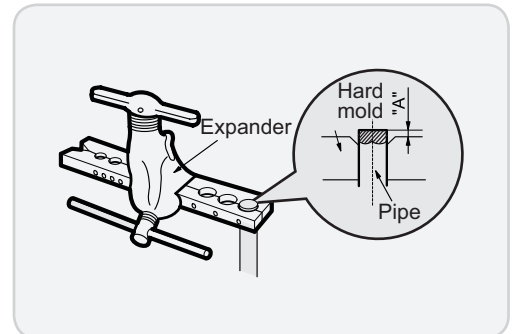

F: Inspection

- Check the quality of expanding port. If there is any blemish, expand the port again according to the steps above.

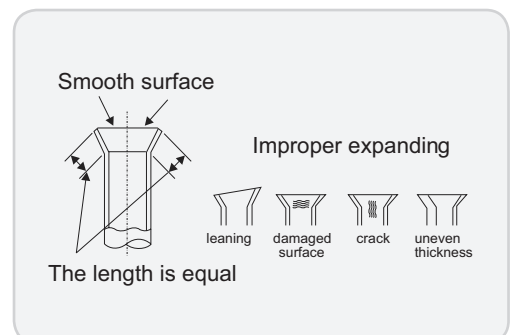

Appendix

Appendix 3: List of Resistance for Temperature Sensor

Resistance Table of Ambient Temperature Sensor for Indoor and Outdoor Units(15K)

Temp(°C)	Resistance(kΩ)
-19	138.10
-18	128.60
-16	115.00
-14	102.90
-12	92.22
-10	82.75
-8	74.35
-6	66.88
-4	60.23
-2	54.31

Temp(°C)	Resistance(kΩ)
0	49.02
2	44.31
4	40.09
6	36.32
8	32.94
10	29.90
12	27.18
14	24.73
16	22.53
18	20.54

Temp(°C)	Resistance(kΩ)
20	18.75
22	17.14
24	15.68
26	14.36
28	13.16
30	12.07
32	11.09
34	10.20
36	9.38
38	8.64

Temp(°C)	Resistance(kΩ)
40	7.97
42	7.35
44	6.79
46	6.28
48	5.81
50	5.38
52	4.99
54	4.63
56	4.29
58	3.99

Resistance Table of Tube Temperature Sensors for Indoor and Outdoor (20K)

Temp(°C)	Resistance(kΩ)
-19	181.40
-15	145.00
-10	110.30
-5	84.61
0	65.37
5	50.87
10	39.87
15	31.47

Temp(°C)	Resistance(kΩ)
20	25.01
25	20.00
30	16.10
35	13.04
40	10.62
45	8.71
50	7.17
55	5.94

Temp(°C)	Resistance(kΩ)
60	4.95
65	4.14
70	3.48
75	2.94
80	2.50
85	2.13
90	1.82
95	1.56

Temp(°C)	Resistance(kΩ)
100	1.35
105	1.16
110	1.01
115	0.88
120	0.77
125	0.67
130	0.59
135	0.52

Resistance Table of Discharge Temperature Sensor for Outdoor(50K)

Temp(°C)	Resistance(kΩ)
-30	911.400
-25	660.8
-20	486.5
-15	362.9
-10	274
-5	209
0	161
5	125.1

Temp(°C)	Resistance(kΩ)
10	98
15	77.35
20	61.48
25	49.19
30	39.61
35	32.09
40	26.15
45	21.43

Temp(°C)	Resistance(kΩ)
50	17.65
55	14.62
60	12.17
65	10.18
70	8.555
75	7.224
80	6.129
85	5.222

Temp(°C)	Resistance(kΩ)
90	4.469
95	3.841
100	3.315
105	2.872
110	2.498
115	2.182
120	1.912
125	1.682



JF00305641



GREE ELECTRIC APPLIANCES, INC. OF ZHUHAI

Add: West Jinji Rd, Qianshan, Zhuhai, Guangdong, China, 519070
Tel: (+86-756) 8522219
Fax: (+86-756) 8669426
E-mail: global@cn.gree.com

For product improvement, specifications and appearance in this manual are subject to change without prior notice.