



T-FRESH INVERTER SERIES_R32

Service Manual

FSU36HP230V1R32AH

GREE ELECTRIC APPLIANCES, INC. OF ZHUHAI

The background features a network of thin grey lines connecting circular nodes, creating a geometric pattern. At the bottom, there are overlapping teal and blue shapes, including a stylized circuit board pattern and a photograph of industrial machinery with pipes and metal structures.

Table of Contents

Part I : Technical Information	1
1. Summary	1
2. Specifications	2
2.1 Specification Sheet.....	2
2.2 Capacity Variation Ratio According to Temperature	4
2.3 Cooling and Heating Data Sheet in Rated Frequency.....	4
3. Outline Dimension Diagram	5
3.1 Indoor Unit.....	5
3.2 Outdoor Unit.....	6
4. Refrigerant System Diagram	7
5. Electrical Part	8
5.1 Wiring Diagram	8
5.2 PCB Printed Diagram	10
6. Function and Control	12
6.1 Function Buttons of Air Conditioner	12
6.2 Remote Controller Introduction of YBE1FB8F	14
6.3 GREE+ App Operation Manual	19
6.4 Ewpe Smart App Operation Manual.....	20
6.5 Description of Each Control Operation	21
Part II : Installation and Maintenance	24
7. Notes for Installation and Maintenance	24
8. Installation	31
8.1 Installation Dimension Diagram.....	31
8.2 Installation Parts-checking	33
8.3 Selection of Installation Location.....	33
8.4 Electric Connection Requirement	33

2. Specifications

2.1 Specification Sheet

Model			FSU36HP230V1R32AH LIV36HP230V1R32AO	
Product Code			/	
Power Supply	Rated Voltage	V~	208/230	
	Rated Frequency	Hz	60	
	Phases		1	
Power Supply Mode		--	Outdoor	
Cooling Capacity		Btu/h	33600	
Heating Capacity		Btu/h	34000	
Cooling Power Input		W	2810	
Heating Power Input		W	2670	
Cooling Current Input		A	13.5	
Heating Current Input		A	14.7	
Rated Input		W	4000	
Rated Cooling Current		A	20	
Rated Heating Current		A	20	
Air Flow Volume		CFM	1148/1059/971/883	
Dehumidifying Volume		Pint/h	7.40	
EER		(Btu/h)/W	12	
COP		(Btu/h)/W	12.7	
SEER		--	20	
HSPF			8.5	
Application Area		yd ²	46-70	
Indoor Unit	Model		FSU36HP230V1R32AH	
	Product Code		CH156N10300	
	Fan Type		Centrifugal	
	Fan Diameter Length(DXL)		mm	Φ379X180.5
	Cooling Speed		r/min	600/560/530/500
	Heating Speed		r/min	600/560/530/500
	Fan Motor Power Output		W	220
	Fan Motor RLA		A	/
	Fan Motor Capacitor		μF	/
	Evaporator Form		--	/
	Evaporator Pipe Diameter		mm	Φ7.94
	Evaporator Row-fin Gap		mm	3-1.5
	Evaporator Coil Length (LXDXW)		mm	/
	Swing Motor Model		--	MP24TA / MP35AB
	Swing Motor Power Output		W	1.5/2.5
	Fuse Current		A	30
	Sound Pressure Level		dB (A)	Cooling:54/52/50/48 Heating:54/52/50/48
	Sound Power Level		dB (A)	Cooling:64/62/60/58 Heating:64/62/60/58
	Dimension (WXHXD)		inch	23 7/64 X 74 3/32 X 15 33/64
	Dimension of Carton Box (LXWXH)		inch	83 21/32 X 28 5/32 X 18 1/2
	Dimension of Package (LXWXH)		inch	83 25/32 X 28 17/64 X 19 3/32
Net Weight		lb	125.7	
Gross Weight		lb	152.1	

Outdoor Unit	Outdoor Unit Model	--	LIV36HP230V1R32AO
	Outdoor Unit Product Code	--	CB574W18100
	Compressor Manufacturer	--	ZHUHAI LANDA COMPRESSOR CO., LTD.
	Compressor Model	--	QXFS-D280zX070
	Compressor Oil	--	FW68DA or equivalent
	Compressor Type	--	Rotary
	Compressor LRA.	A	40
	Compressor RLA	A	16
	Compressor Power Input	W	2294
	Compressor Overload Protector	--	/
	Throttling Method	--	Electron expansion valve
	Set Temperature Range	°F	61~86
	Cooling Operation Ambient Temperature Range	°F	-4~122
	Heating Operation Ambient Temperature Range	°F	-13~75
	Condenser Form	--	Aluminum Fin-copper Tube
	Condenser Pipe Diameter	mm	Φ7
	Condenser Rows-fin Gap	mm	2-1.4
	Condenser Coil Length (LXDXW)	mm	955X38.1X704
	Fan Motor Speed	rpm	850
	Fan Motor Power Output	W	90
	Fan Motor RLA	A	1.7
	Fan Motor Capacitor	μF	/
	Outdoor Unit Air Flow Volume	m ³ /h	4500
	Fan Type	--	Axial-flow
	Fan Diameter	mm	Φ570
	Defrosting Method	--	Automatic Defrosting
	Climate Type	--	T1
	Isolation	--	I
	Moisture Protection	--	IPX4
	Permissible Excessive Operating Pressure for the Discharge Side	MPa	4.3
	Permissible Excessive Operating Pressure for the Suction Side	MPa	2.5
	Sound Pressure Level	dB (A)	62
	Sound Power Level	dB (A)	72
Dimension(WXHXD)	inch	39 3/8 X 29 3/8 X 16 13/16	
Dimension of Carton Box (LXWXH)	inch	42 13/32 X 18 57/64 X 30 29/32	
Dimension of Package(LXWXH)	inch	42 33/64 X 19 1/64 X 31 57/64	
Net Weight	lb	122.4	
Gross Weight	lb	133.4	
Refrigerant	--	R32	
Refrigerant Charge	oz	56.4	
Connection Pipe	Connection Pipe Length	ft	24.6
	Connection Pipe Gas Additional Charge	oz/ft.	0.4
	Outer Diameter Liquid Pipe	inch	1/4
	Outer Diameter Gas Pipe	inch	5/8
	Max Distance Height	ft	82
	Max Distance Length	ft	131.2
	Note: The connection pipe applies metric diameter.		

The above data is subject to change without notice. Please refer to the nameplate of the unit.

2.2 Capacity Variation Ratio According to Temperature

Cooling:

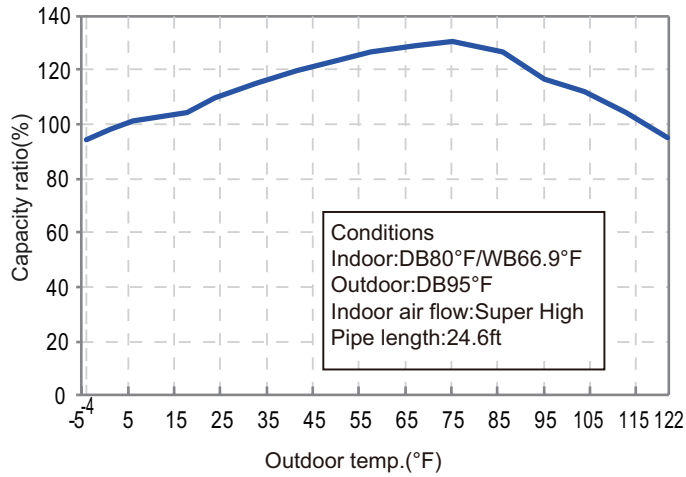

Heating:

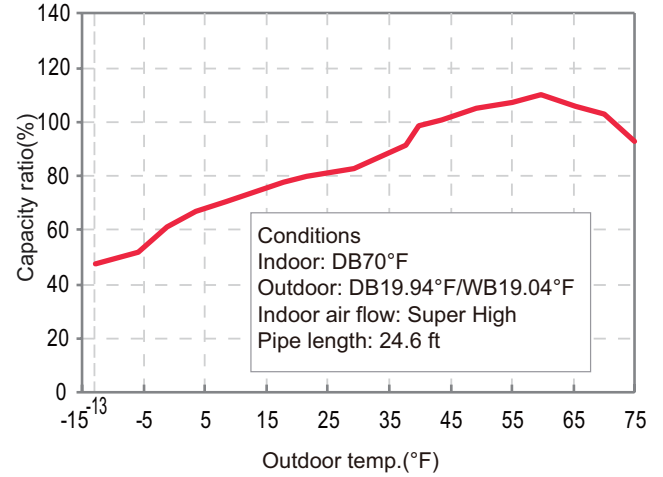

2.3 Cooling and Heating Data Sheet in Rated Frequency

Cooling:

Rated cooling condition(°F) (DB/WB)		Model	Pressure of gas pipe connecting indoor and outdoor unit P (MPa)	Inlet and outlet pipe temperature of heat exchanger		Fan speed of indoor unit	Fan speed of outdoor unit
Indoor	Outdoor			T1 (°F)	T2 (°F)		
80/66.9	95/-	36K	0.8~1.1	46.8 to 52.8	127 to 96.8	Super High	High

Heating:

Rated heating condition(°F) (DB/WB)		Model	Pressure of gas pipe connecting indoor and outdoor unit P (MPa)	Inlet and outlet pipe temperature of heat exchanger		Fan speed of indoor unit	Fan speed of outdoor unit
Indoor	Outdoor			T1 (°F)	T2 (°F)		
70/-	19.94/19.04	36K	2.5~2.7	134.4 to 102	36 to 39	Super High	High

Instruction:

T1: Inlet and outlet pipe temperature of evaporator

T2: Inlet and outlet pipe temperature of condenser

P: Pressure at the side of big valve

Connection pipe length: 24.6ft.

3.2 Outdoor Unit

36K

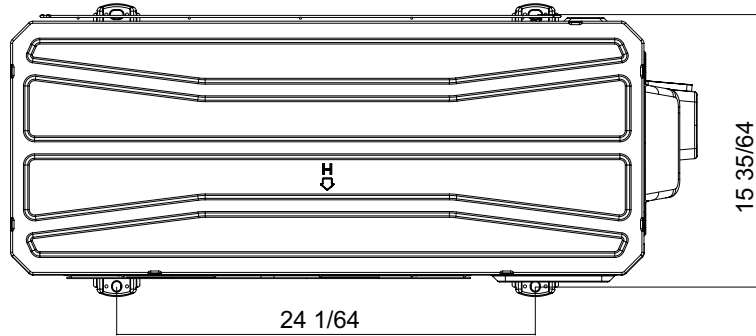
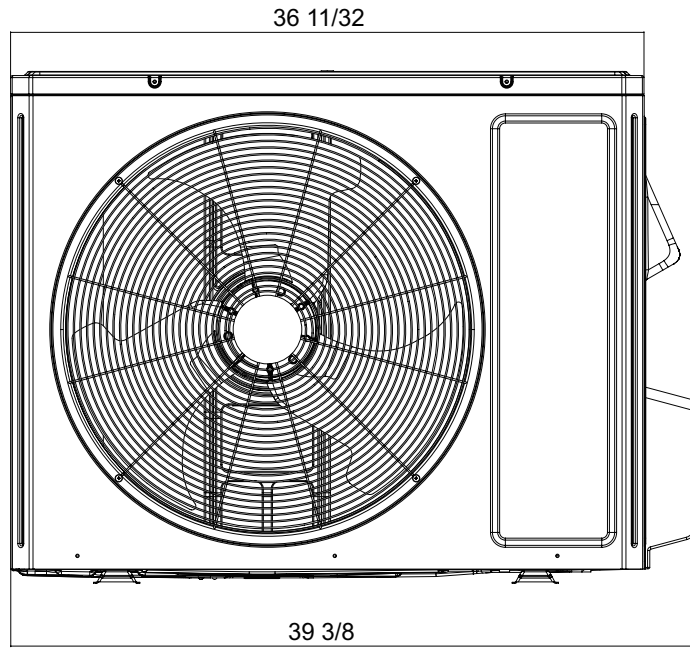
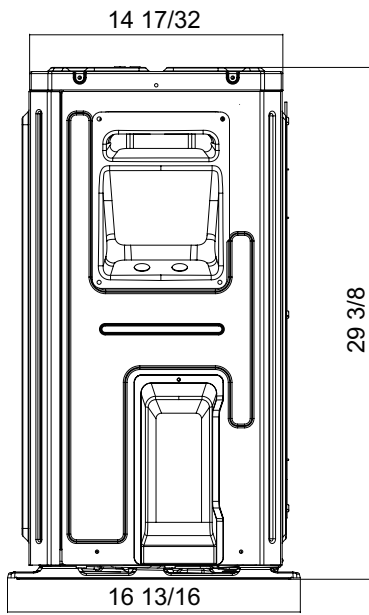

Unit:inch

4. Refrigerant System Diagram

Heat pump model:

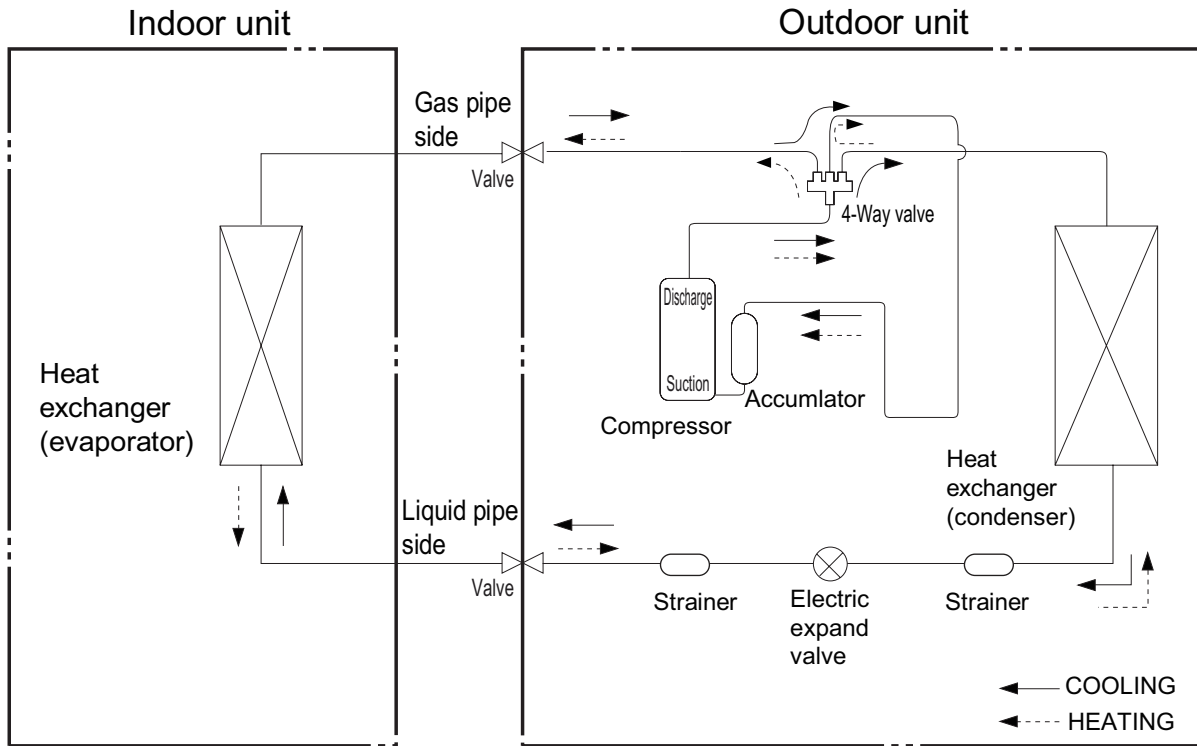

Connection pipe specification:

Liquid pipe: 1/4"

Gas pipe: 5/8"

5. Electrical Part

5.1 Wiring Diagram

• Instruction

Symbol	Symbol Color	Symbol	Symbol Color	Symbol	Name
YE	Yellow	BN	Brown	COMP	Compressor
RD	Red	BU	Blue		Grounding wire
YEGN	Yellow/Green	BK	Black	/	/

Note: Jumper cap is used to determine fan speed and the swing angle of horizontal louver for this model.

• Indoor Unit

36K

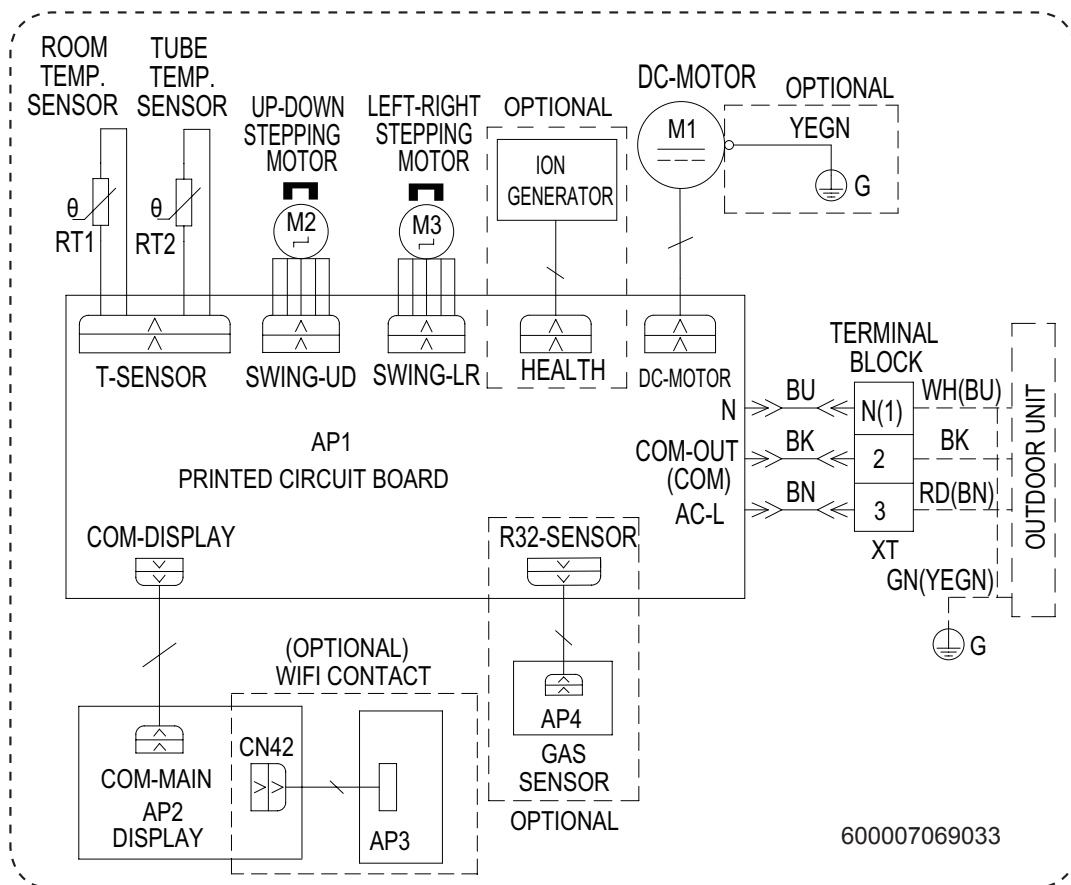

● Outdoor Unit

36K

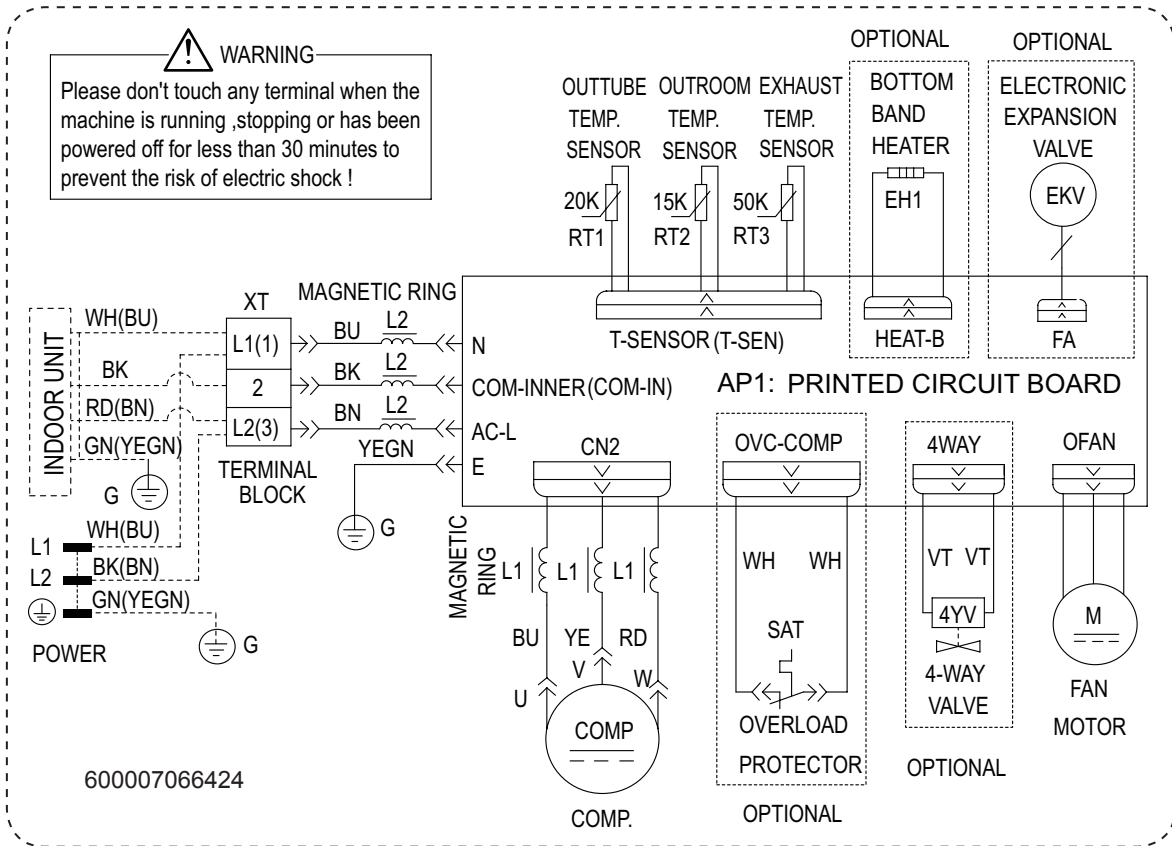

These wiring diagrams are subject to change without notice; please refer to the one supplied with the unit.

6. Function and Control

6.1 Function Buttons of Air Conditioner

Buttons Name and Function

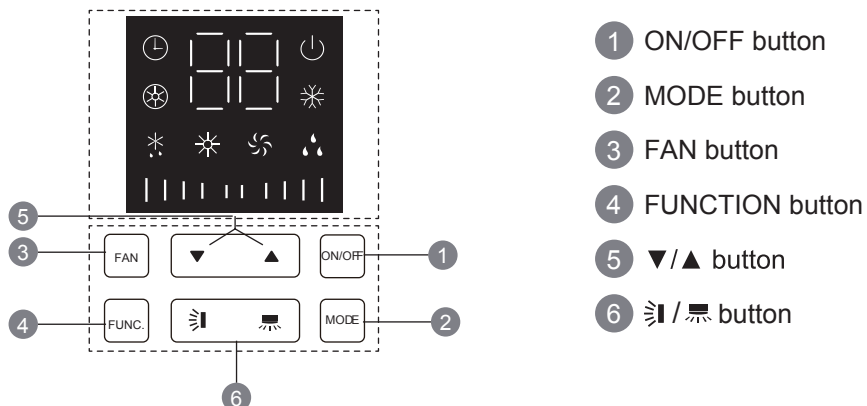

Introduction for icons on display screen of air conditioner

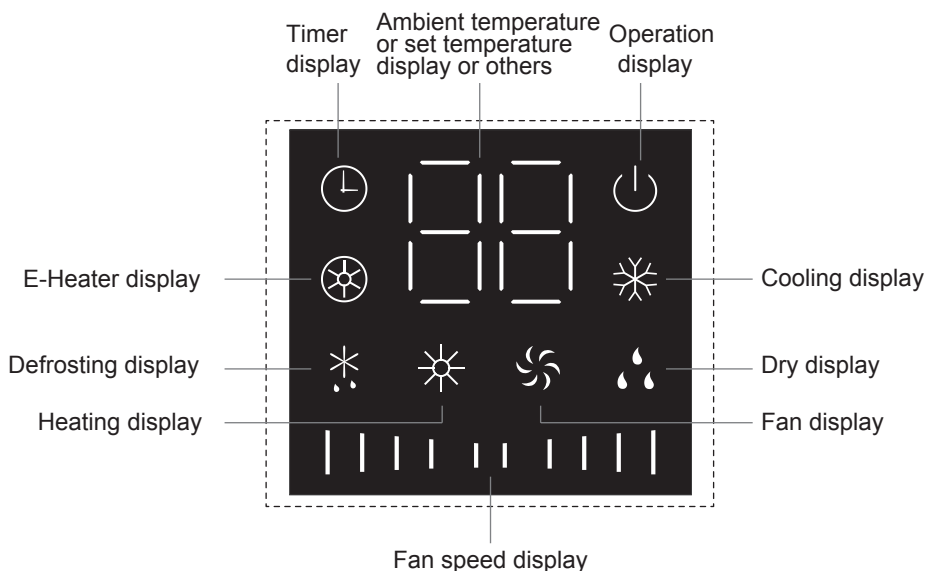

NOTE:

This series unit adopts touch buttons. You only need to touch the buttons slightly.

1. ON/OFF button

- Press this button to turn on or turn off the unit. (Note: Under X-FAN mode, press this button to turn on the unit directly.)

2. MODE button

- Every time press this button, the mode will switchover in cycle among.

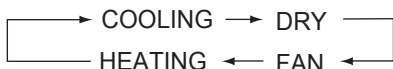

(Note: Cooling only unit won't accept heating operation signal.)

For cooling only unit, pressing MODE button under FAN mode will skip heating mode and enter cooling mode.)

3. FAN button

Press this button and then fan speed can be selected and displayed in the sequence as below:

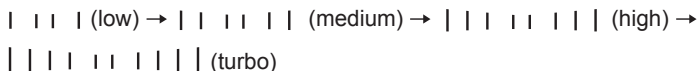

(Note: Only low fan speed is available for dry mode. Fan speed can't be adjusted under dry mode. Turbo cannot be set in FAN mode.)

4. FUNCTION button

Under on status, press Function button to switch between timer and auxiliary heating function setting (auxiliary heating can be

set only in heating mode). When timer or auxiliary heating icon is blinking, it means this function can be set. Press "▲" or "▼" button to set function. If there's no operation change within 5s after setting is finished, the function setting will be confirmed. Or press Function button again to exit or confirm the function. When the function is selected through Function button, if the unit is not turned off and no remote control signal is received within 2min, pressing FUNCTION button again to circulate from the previous set function. After 2min or the unit is turned off or remote control signal is received, pressing FUNCTION button again to circulate from timer icon. (Note: Only when the unit is under heating mode and with auxiliary heating function, auxiliary heating function can be turned on or off through FUNCTION button.)

- Under off status, if the unit is in X-FAN status, press Function button to turn off the unit directly; if the unit is not in X-FAN status, press FUNCTION button to set timer ON.

5. ▲ / ▼ button

- After each pressing of "▲" or "▼" button, set temperature will increase or decrease 1°C. Temperature adjustment range is 16°C~30°C. This button is invalid under auto mode. Timer setting can be set in 1h increment among 0~24h. When it is adjusted to auxiliary heating function setting through Function button, press this button to turn on or turn off auxiliary heating. (Note: auxiliary heating is valid only for the model with this function.)

- Hold "▲" and "▼" buttons for 3s and the air conditioner will display "LC", which indicates buttons are locked. Any button under on status or ON/OFF button and function buttons under off status are all invalid. Hold these two button for 3s again to release the lock.

6. ㉔ / ㉕ button

- Left and right swing: this button controls the left and right swing motor, single press it to switchover between ON and OFF.
- Up and down swing: this button controls the up and down swing motor, single press it to switchover between ON and OFF.

Set upper and lower limit of temperature

- Under off status, hold "▲" button for 5s to set the upper limit of temperature and then the set upper limit temperature will flash; hold "▲" or "▼" button to adjust the upper limit of temperature and then the set upper limit temperature will be displayed for 3s.
- Under off status, hold "▼" button for 5s to set the lower limit of temperature and the set lower limit temperature will flash; hold "▲" or "▼" button to adjust the lower limit of temperature, and then the set lower.

Note:

1. After setting upper/lower limit temperature, it's valid under cooling, heating, dry and fan modes.
2. The set lower limit temperature should be lower than the set

upper limit temperature.

3. Upper temperature limit can be set only after the lower temperature limit has been set; lower temperature limit can be set only after the upper temperature limit has been set.

4. Note: If it needs to enter compulsive defrosting, freon recovery or adjustable memory function, resume the set upper/lower limit temperature to 16°C-30°C manually.

This function is only available for some models.

Icon function introduction



Operation display

It indicates the air conditioner is put through the power. Under on status, this indicator is on; under off status, this indicator is off.



Timer display

When this indicator is on, it indicates the timer function is turned on.



Heating display

When this indicator is on, it indicates the heating mode is turned on.



Defrosting display

When this indicator is on, it indicates the defrosting function is turned on.



Dry display

When this indicator is on, it indicates the dry mode is turned on.



E-Heater display

When this indicator is on, it indicates the E-heater function is turned on. (Only available for some heat pump unit)



Cooling display

When this indicator is on, it indicates the cooling mode is turned on.



Fan display

When this indicator is on, it indicates the fan mode is turned on.



Fan speed display

Displays the fan speed. The fan speed is displayed as below:

| | | | (low) → | | | | | (medium) → | | | | | | (high) →
| | | | | | | | (turbo)

6.2 Remote Controller Introduction of YBE1FB8F

Buttons on remote controller



	Quiet	
	Set fan speed	
	Turbo mode	
	Send signal	
Operation mode		Auto mode
		Cool mode
		Dry mode
		Fan mode
		Heat mode
		Set temperature
	Indoor ambient temp.	
	Power limiting operation	
ON/OFF	TIMER ON / TIMER OFF	
	Set time	
	Left & right swing	
	Up & down swing	
	Child lock	
	Air function	
	X-FAN function	
	Health function	
WiFi	WiFi function	
	LED	
	I feel	
	Sleep mode	
	Fast cool	

Introduction for buttons on remote controller

NOTE:

- This is a general use remote controller. It could be used for the air conditioner with multifunction. For the functions which the model doesn't have, if press the corresponding button on the remote controller, the unit will keep the original running status.
- After putting through the power, the air conditioner will give out a sound. Operation indicator "⏻" is ON. After that, you can operate the air conditioner by using remote controller.
- Under on status, pressing the button on the remote controller, the signal icon "📶" on the display of remote controller will blink once and the air conditioner will give out a "di" sound, which means the signal has been sent to the air conditioner.

ON/OFF button

Press this button to turn on the unit. Press this button again to turn off the unit.

MODE button

Press this button to select your required operation mode.



- When selecting auto mode, air conditioner will operate

automatically according to the sensed temperature. Set temperature can't be adjusted and will not be displayed as well. Press "Fan" button can adjust fan speed. Press "🌀" / "🌀" button can adjust fan blowing angle.

- After selecting cool mode, air conditioner will operate under cool mode. Press " + " or " - " button to adjust set temperature. Press "Fan" button to adjust fan speed. Press "🌀" / "🌀" button to adjust fan blowing angle.

- When selecting dry mode, the air conditioner operates at low speed under dry mode. Under dry mode, fan speed can't be adjusted. Press "🌀" / "🌀" button to adjust fan blowing angle.

When selecting fan mode, the air conditioner will only blow fan, no cooling and no heating. Press "Fan" button to adjust fan speed. Press "🌀" / "🌀" button to adjust fan blowing angle.

NOTE:

- For preventing cold air, after starting up heat mode, indoor unit will delay 1~5 minutes to blow air (Actual delay time depends on indoor ambient temperature).
- Set temperature range from remote controller: 16~30°C (61~86°F).

- This mode indicator is not available for some models.
- Cooling only unit won't receive heat mode signal. If setting heat mode with remote controller, press " On/Off " button can't start up the unit.

Fan button

This button is used for setting Fan Speed in the sequence that goes from AUTO, , , , to , then back to Auto.



NOTE:

- It's low fan speed under dry mode.
- X-FAN function Hold fan speed button for 2s in cool or dry mode, the icon " " is displayed and the indoor fan will continue operation for a few minutes in order to dry the indoor unit even though you have turned off the unit. After energization, X-FAN OFF is defaulted. X-FAN is not available in auto, fan or heat mode.

This function indicates that moisture on evaporator of indoor unit will be blown after the unit is stopped to avoid mould.

- Having set X-FAN function on: After turning off the unit by pressing " On/Off " button indoor fan will continue running for a few minutes. at low speed. In this period, Hold fan speed button for 2s to stop indoor fan directly.
- Having set X-FAN function off: After turning off the unit by pressing " On/Off " button, the complete unit will be off directly.

+ / - button

Press " + " or " - " button once increase or decrease set temperature 1°C(°F). Holding " + " or " - " button, 2s later, set temperature on remote controller will change quickly. On releasing button after setting is finished, temperature indicator on indoor unit will change accordingly.

Wifi button

Press "Wifi" button to turn on WiFi function, "Wifi" icon will be displayed on the remote controller; Hold "Wifi" button for 5s to turn off WiFi function and "Wifi" icon will disappear.

Under off status, press "Mode" and "Wifi" buttons simultaneously for 1s, WiFi module will restore factory settings.

NOTE

- This function is only available for some models.

Health button

Press this button to turn on or turn off the health and air functions in operation status. Press this button for the first time to start air

function; LCD displays . Press the button for the second time to start health and air functions simultaneously; LCD displays and . Press this button for the third time to quit health and air functions simultaneously. Press the button for the fourth time to start health function; LCD display . Press this button again to repeat the operation above.

NOTE

- This function is only available for some models.

UD-swing button

Press this button can select up & down swing angle.

Fan blow angle can be selected circularly as below:

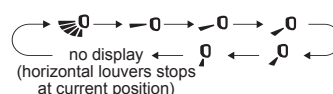

- When selecting " ", air conditioner is blowing fan automatically. Horizontal louver will automatically swing up & down at maximum angle.
- When selecting " ", a ir conditioner is blowing fan at fixed position. Horizontal louver will stop at the fixed position.
- Hold " " button above 2s to set your required swing angle. When reaching your required angle, release the button.

NOTE

Press this button continuously more than 2s, the main unit will swing back and forth from up to down, and then loosen the button, the unit will stop swinging and present position of guide louver will be kept immediately.

Under swing up and down mode, when the status is switched from off to , if press this button again 2s later, status will switch to off status directly; if press this button again within 2s, the change of swing status will also depend on the circulation sequence stated above.

Button

function is for limiting power of the whole unit.

Press this button, the remote controller will circularlym display as the following:

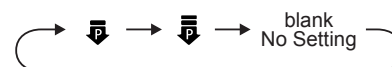

- Maximum power limited under the mode is lower than that of mode.
- If you want to cancel the power limiting function, press "Mode" and "Sleep" buttons simultaneously till the icon in remote controller is not displayed.
- When the remote controller is turned off, power limiting function is cancelled. If you want to activate the function, please repress "Mode" and "Sleep" buttons simultaneously.

- If the current power is lower than the maximum power of  mode, then the power will not be limited after entering into such mode.
- For the model with one outdoor unit and two indoor units, if any one of indoor units enters into power limiting function, the outdoor unit will enter into the set limiting power mode of indoor unit; when two indoor units enter into power limiting mode, then the power of outdoor unit will be limited according to the lower power of the two indoor units.

NOTE

- This button is only available for the model with such function.



LR-swing button:

Press this button can select left & right swing angle.

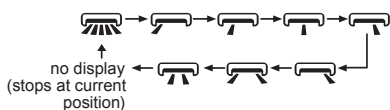
Fan blow angle can be selected circularly as below:



NOTE

- Press this button continuously more than 2s, the main unit will swing back and forth from left to right, and then loosen the button, the unit will stop swinging and present position of guide louver will be kept immediately.
- Under swing left and right mode, when the status is switched from off to , if press this button again 2s later,  status will switch to off status directly; if press this button again within 2s, the change of swing status will also depend on the circulation sequence stated above.
- This function only applicable for some models.

Timer button

- At ON status, press this button once can set TIMER OFF. The character of HOUR and OFF will flash. Press "+" or "-" button within 5s can adjust the time of TIMER OFF. After each pressing of "+" or "-" button, time will increase or decrease half an hour. When holding "+" or "-" button, 2s later, the time will change quickly until to reach to your required time. After that, press "Timer" button to confirm it. The character of HOUR and OFF won't flash again.

Cancel TIMER OFF: Press "Timer" button again under TIMER OFF status.

- At OFF status, press this button once can set TIMER ON. Please refer to TIMER off for detailed operation.

Cancel TIMER ON: Press "Timer" button again under TIMER ON status.

NOTE

- Time setting range: 0.5-24 hours.
- Time interval between two operations can't exceed 5s. Otherwise, remote controller will exit the setting status automatically.

Sleep button

Under Cool or Heat mode, press this button to turn on Sleep function. Press this button again to cancel Sleep function. Under Fan, Auto and Dry modes, this function is unavailable.

Light button

Press this button to control the LED status on the display, the circulation change is as follow:

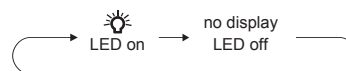

Function introduction for combination buttons

Energy-saving function

Under cooling mode, press "Mode" and "Timer" buttons simultaneously to start up or turn off energy-saving function. When energy-saving function is started up, "SE" will be shown on remote controller, and air conditioner will adjust the set temperature automatically according to ex-factory setting to reach to the best energy-saving effect.

Press "Mode" and "Timer" buttons simultaneously again to exit energy-saving function.

NOTE

Under energy-saving function, fan speed is defaulted at auto speed and it can't be adjusted.

Under energy-saving function, set temperature can't be adjusted.

Sleep function and energy-saving function can't operate at the same time. If energy-saving function has been set under cool mode, press "Sleep" button will cancel energy-saving function. If sleep function has been set under cool mode, start up the energy-saving function will cancel sleep function.

8°C heating function

Under heat mode, press "Mode" and "Timer" buttons simultaneously to start up or turn off 8°C heating function. When this function is started up, " " and "8°C" will be shown on remote controller, and the air conditioner keep the heating status at 8°C.

Press "Mode" and "Timer" buttons simultaneously again to exit 8°C heating function.



NOTE

- Under 8°C heating function, fan speed is defaulted at auto speed and it can't be adjusted.
- Under 8°C heating function, set temperature can't be adjusted.
- Sleep function and 8°C heating function can't operate at the same time. If 8°C heating function has been set under heat mode, press " " button will cancel 8°C heating function. If sleep function

has been set under heat mode, start up the 8°C heating function will cancel sleep function.

- Under °F temperature display, the remote controller will display 46°F heating.

Child lock function

Hold " On/Off " and " - " buttons simultaneously for 3s to turn on or turn off child lock function. When child lock function is on, "  " icon is displayed on remote controller. If you operate the remote controller, the "  " icon will blink three times without sending signal to the unit.

Temperature display switchover function

Under OFF status, hold "Mode" and " - " buttons simultaneously for 3s to switch temperature display between °C and °F.

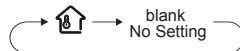

Indoor ambient temperature

By holding " On/Off " and "  " buttons simultaneously, you can see indoor ambient temperature on indoor unit's display. The setting on remote controller is selected circularly as below:



- When selecting "  " with remote controller, temperature indicator on indoor unit displays indoor ambient temperature.

Clean reminder function of filter

The reminder function is defaulted to be OFF. Hold " On/Off " and "  " buttons simultaneously for 5s to turn it on. The buzzer will give out sound for 0.5s and the dual-8 nixie tube on the display will be on for 3s; Once the reminder function is turned on, when the air conditioner has reached to the set time, the dual-8 nixie tube will flash about 30s when the unit is turned on each time to remind the user to clean the filter; you can turn off this cycle reminder by holding " On/Off " and "  " buttons simultaneously for 5s and then the air conditioner will count time again.

NOTE

- Once the reminder function is turned on, only this cycle reminder can be cleared.
- This function is only available for some models.

Auto clean function

Under unit off status, hold "Mode" and "  " buttons simultaneously for 5s to turn on or turn off the auto clean function. When the auto clean function is turned on, indoor unit displays "CL". During the auto clean process of evaporator, the unit will perform fast cooling or fast heating. There may be some noise, which is the sound of flowing liquid or thermal expansion or cold shrinkage. The air conditioner may blow cool or warm air, which is a normal phenomenon. During cleaning process, please make sure the room is well ventilated to avoid affecting the comfort.

NOTE

- The auto clean function can only work under normal ambient temperature. If the room is dusty, clean it once a month; if not, clean it once every three months. After the auto clean function is turned on, you can leave the room. When auto clean is finished, the air conditioner will enter standby status.

- This function is only available for some models.

Night mode

Under cooling or heating mode, when turning on sleep mode and turn to low speed or quiet notch, the outdoor unit would enter into night mode.

NOTE

- When you feel that the cooling and heating effect is poor, please press "Fan" button to other fan speed or press "Sleep" button to exit the night mode.

- The night mode can only work under normal ambient temperature.

- This function is only available for some models.

I FEEL function

Press "Health" and " + " buttons simultaneously to start I FEEL function and "  " will be displayed on the remote controller. After this function is set, the remote controller will send the detected ambient

temperature to the controller and the unit will automatically adjust the indoor temperature according to the detected temperature. Press "Health" and " + " buttons simultaneously again to turn off I FEEL function and "  " will disappear.

- Please put the remote controller near user when this function is set. Do not put the remote controller near the object of high temperature or low temperature in order to avoid detecting inaccurate ambient temperature. When I FEEL function is turned on, the remote controller should be put within the area where indoor unit can receive the signal sent by the remote controller.

Replacement of batteries in remote controller

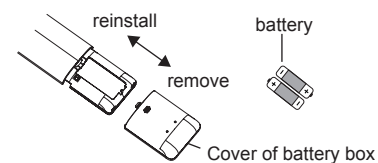

1. Press the back side of remote controller marked with "  ", as shown in the fig, and then push out the cover of battery box along the arrow direction.
2. Replace two 7# (AAA 1.5V) dry batteries, and make sure the position of "+" polar and "-" polar are correct.
3. Reinstall the cover of battery box.

NOTICE

- During operation, point the remote control signal sender at the

receiving window on indoor unit.

- The distance between signal sender and receiving window should be no more than 8m, and there should be no obstacles between them.
- Signal may be interfered easily in the room where there is fluorescent lamp or wireless telephone; remote controller should be close to indoor unit during operation.
- Replace new batteries of the same model when replacement is required.
- When you don't use remote controller for a long time, please take out the batteries.
- If the display on remote controller is fuzzy or there's no display, please replace batteries.

6.3 GREE+ App Operation Manual

Control Flow Chart

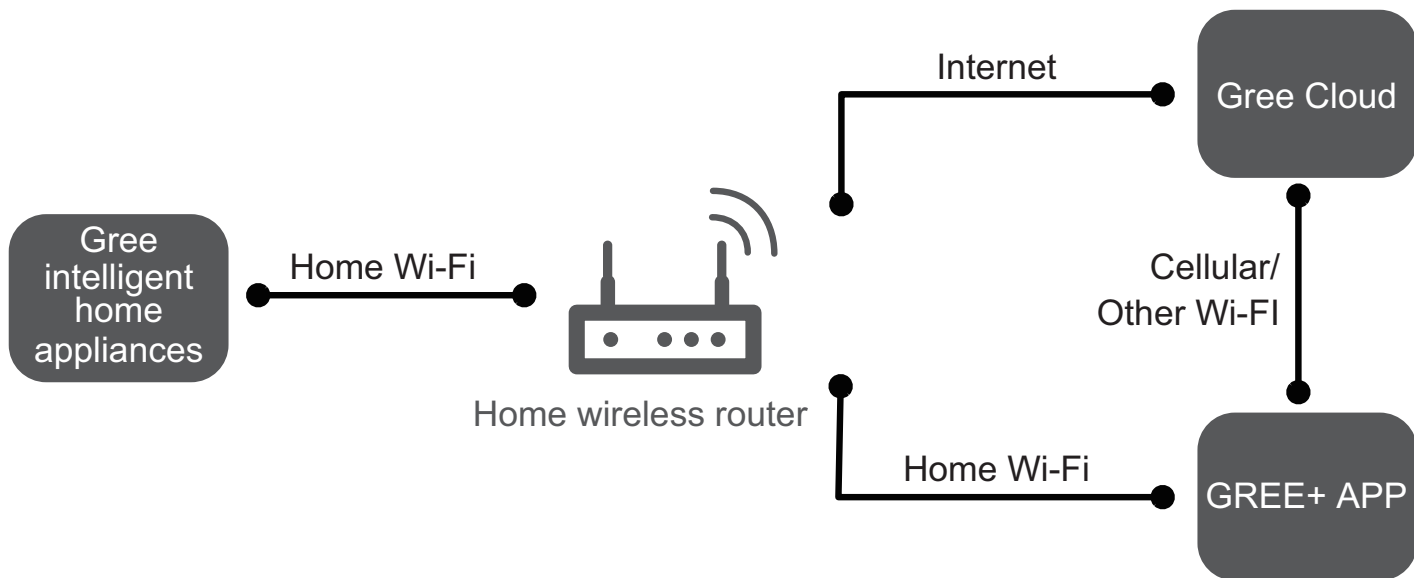

Operating Systems

Requirement for User's smart phone:



iOS system
Support iOS7.0 and
above version



Android system
Support Android 4.4 and
above version

Download and installation



GREE+ App Download Linkage

Scan the QR code or search "GREE+" in the application market to download and install it. When "GREE+" App is installed, register the account and add the device to achieve long-distance control and LAN control of Gree smart home appliances. For more information, please refer to "Help" in App.

6.4 Ewpe Smart App Operation Manual

Control Flow Chart

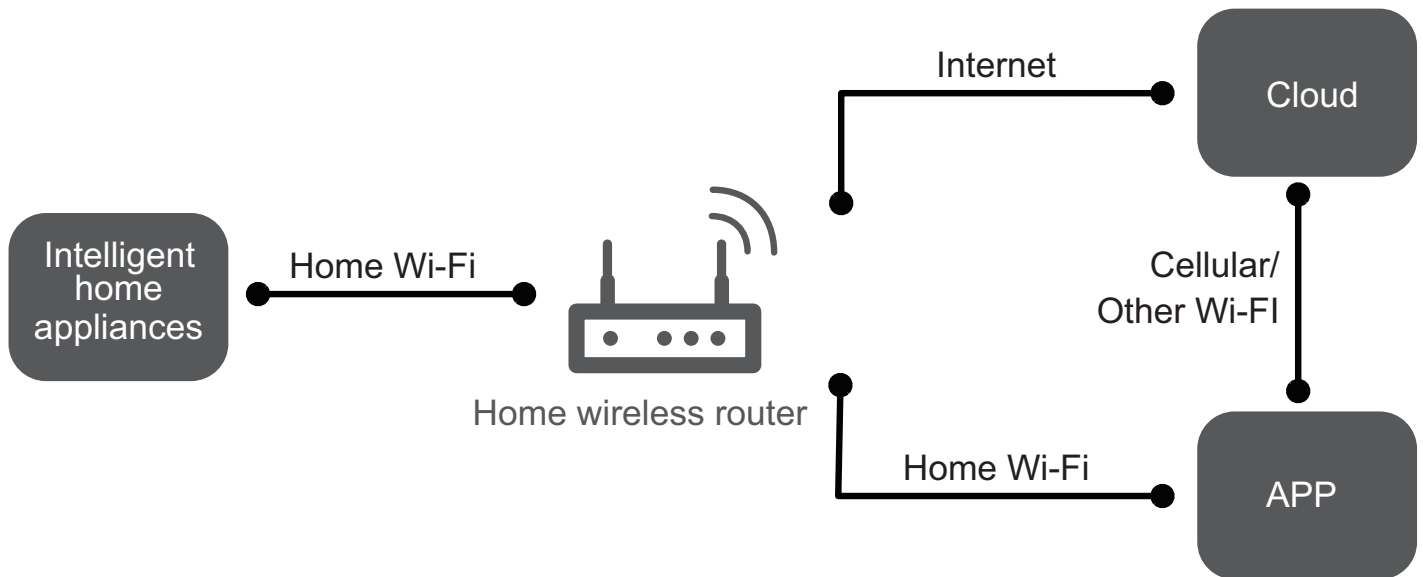

Operating Systems

Requirement for User's smart phone:



iOS system
Support iOS7.0 and
above version



Android system
Support Android 4.4 and
above version

Download and installation



App Download Linkage

Scan the QR code or search "Ewpe Smart" in the application market to download and install it. When "Ewpe Smart" App is installed, register the account and add the device to achieve long-distance control and LAN control of smart home appliances.

For more information, please refer to "Help" in App.

6.5 Description of Each Control Operation

● Indoor Unit

1. Basic function of system

(1) Cooling mode

(1) Under this mode, fan and swing operates at setting status. Temperature setting range is 16~30°C.

(2) During malfunction of outdoor unit or the unit is stopped because of protection, indoor unit keeps original operation status.

(2) Drying mode

(1) Under this mode, fan operates at low speed and swing operates at setting status. Temperature setting range is 16~30°C.

(2) During malfunction of outdoor unit or the unit is stopped because of protection, indoor unit keeps original operation status.

(3) Protection status is same as that under cooling mode.

(4) Sleep function is not available for drying mode.

(3) Heating mode

(1) Under this mode, Temperature setting range is 16~30°C.

(2) Working condition and process for heating mode:

When turn on the unit under heating mode, indoor unit enters into cold air prevention status. When the unit is stopped or at OFF status, and indoor unit has been started up just now, the unit enters into residual heat-blowing status.

(4) Working method for AUTO mode:

1. Working condition and process for AUTO mode:

a. Under AUTO mode, standard heating $T_{\text{preset}}=20^{\circ}\text{C}$ and standard cooling $T_{\text{preset}}=25^{\circ}\text{C}$. The unit will switch mode automatically according to ambient temperature.

2. Protection function

a. During cooling operation, protection function is same as that under cooling mode.

b. During heating operation, protection function is same as that under heating mode.

3. Display: Set temperature is the set value under each condition. Ambient temperature is ($T_{\text{amb.}}-T_{\text{compensation}}$) for heat pump unit and $T_{\text{amb.}}$ for cooling only unit.

4. If there's I feel function, $T_{\text{compensation}}$ is 0. Others are same as above.

(5) Fan mode

Under this mode, indoor fan operates at set fan speed. Compressor, outdoor fan, 4-way valve and electric heating tube stop operation. Indoor fan can select to operate at high, medium, low or auto fan speed. Temperature setting range is 16~30°C.

2. Other control

(1) Buzzer

Upon energization or availablely operating the unit or remote controller, the buzzer will give out a beep.

(2) Auto button

If press this auto button when turning off the unit, the complete unit will operate at auto mode. Indoor fan operates at auto fan speed and swing function is turned on. Press this auto button at ON status to turn off the unit.

(3) Auto fan

Heating mode: During auto heating mode or normal heating mode, auto fan speed will adjust the fan speed automatically according to ambient temperature and set temperature.

(4) Sleep

After setting sleep function for a period of time, system will adjust set temperature automatically.

(5) Timer function:

General timer and clock timer functions are compatible by equipping remote controller with different functions.

(6) Memory function

memorize compensation temperature, off-peak energization value.

Memory content: mode, up&down swing, light, set temperature, set fan speed, general timer (clock timer can't be memorized).

After power recovery, the unit will be turned on automatically according to memory content.

(7) Health function

During operation of indoor fan, set health function by remote controller. Turn off the unit will also turn off health function.

Turn on the unit by pressing auto button, and the health is defaulted ON.

Once compressor is started, it won't stop within 6 mins according to the change of room temp.

(1) Auto mode

① Operation condition and process for auto mode

Under auto mode, the system will automatically select operation mode (cooling, heating, and fan) according to indoor ambient temperature. There will be 30s delayed for protection between mode switchover.

◆ When $T_{\text{amb.}} \geq 26^{\circ}\text{C}$, unit will be in cooling mode. Ex-factory set temperature is 25°C

◆ Cooling and heating unit: When $T_{\text{amb.}} \leq (19^{\circ}\text{C} + T_{\text{compensation}})$, unit will be in heating mode $T_{\text{preset}}=20^{\circ}\text{C}$.

◆ Cooling only unit: When $T_{\text{amb.}} \leq 22^{\circ}\text{C}$ (or 72°F), unit will be in

fan mode $T_{\text{preset}}=25^{\circ}\text{C}$.

◆ For cooling and heating unit under condition that $(19^{\circ}\text{C} + T_{\text{compensation}}) < T_{\text{amb}} < 26^{\circ}\text{C}$ (For cooling only unit under condition that $22^{\circ}\text{C} < T_{\text{amb}} < 26^{\circ}\text{C}$), when unit is initially turned on in auto mode, it will operate according to auto fan mode. When unit is changed to auto mode from other modes, it will maintain its previous working status (If auto mode is turned on from drying mode, unit will operate according to auto fan mode).

② Protection function is same as that under each mode.

(2) Cooling mode

① Operation condition and process for cooling mode

◆ When $T_{\text{amb}} \geq T_{\text{set}} + 1^{\circ}\text{C}$, the system operates under cooling mode. In this case, the compressor, the ODU fan motor and the IDU fan motor operates at set speed.

◆ When $T_{\text{amb}} \leq T_{\text{set}} - 1^{\circ}\text{C}$, the compressor and the ODU fan motor stop, while the IDU fan motor operates at set speed.

◆ When $T_{\text{set}} - 1^{\circ}\text{C} < T_{\text{amb}} < T_{\text{set}} + 1^{\circ}\text{C}$, the system will maintain its previous operation status.

In cooling mode, the 4-way valve is de-energized (4-way valve is not available for cooling only unit). Temperature setting range is $16\sim 30^{\circ}\text{C}$.

(8) I feel control mode

After controller received I feel control signal and ambient temperature sent by remote controller, controller will work according to the ambient temperature sent by remote controller.

(9) Entry condition for compulsory defrosting function

When turn on the unit under heating mode and set temperature is 16°C (or 16.5°C by remote controller), press “ Δ , ∇ , Δ , ∇ , Δ , ∇ ” button successively within 5s and then indoor unit will enter into compulsory defrosting setting status:

(1) If there's only indoor units controller, it enters into indoor normal defrosting mode.

(2) If there's indoor units controller and outdoor units controller, indoor unit will send compulsory defrosting mode signal to outdoor unit and then outdoor unit will operate under normal defrosting mode. After indoor unit received the signal that outdoor unit has entered into defrosting status, indoor unit will cancel to send compulsory mode to outdoor unit. If outdoor unit hasn't received feedback signal from outdoor unit after 3min, indoor unit will also cancel to send compulsory defrosting signal.

(10) Refrigerant recovery function:

Enter into Freon recovery mode actively: Within 5min after energization, turn on the unit at 16°C under cooling mode, and press light button for 3 times within 3s to enter into Freon recovery mode. Fo is displayed and Freon recovery mode will be sent to outdoor unit.

(11) Ambient temperature display control mode

1. When user set the remote controller to display set temperature (corresponding remote control code: 01), current set temperature will be displayed.

2. Only when remote control signal is switched to indoor ambient temperature display status (corresponding remote control code: 10) from other display status (corresponding remote control code: 00, 01, 11), controller will display indoor ambient temperature for 3s and then turn back to display set temperature.

Under this mode, indoor fan operates at set fan speed. Compressor, outdoor fan, 4-way valve and electric heating tube stop operation. Indoor fan can select to operate at high, medium, low or auto fan speed. Temperature setting range is $16\sim 30^{\circ}\text{C}$.

(12) Off-peak energization function:

Adjust compressors minimum stop time. The original minimum stop time is 180s and then we change to:

The time interval between two start-ups of compressor can't be less than $180 + T_s (0 \leq T_s \leq 15)$. T is the variable of controller. That's to say the minimum stop time of compressor is 180s~195s. Read-in T into memory chip when refurbish the memory chip each time. After power recovery, compressor can only be started up after $180 + T$ s at least.

(13) SE control mode

The unit operates at SE status.

(14) X-fan mode

When X-fan function is turned on, after turn off the unit, indoor fan will still operate at low speed for 2min and then the complete unit will be turned off. When x-fan function is turned off, after turn off the unit, the complete unit will be turned off directly.

(15) 8°C heating function

Under heating mode, you can set 8°C heating function by remote controller. The system will operate at 8°C set temperature.

(16) Turbo function

Turbo function can be set under cooling and heating modes. Press Fan Speed button to cancel turbo setting. Turbo function is not available under auto, drying and fan modes.

● Outdoor Unit

1. Cooling mode:

Working condition and process of cooling mode:

① When $T_{\text{indoor ambient temperature}} \geq T_{\text{preset}}$, unit enters into cooling mode. Indoor fan, outdoor fan and compressor start operation. Indoor fan operates according to set fan speed.

② When $T_{\text{indoor ambient temperature}} \leq T_{\text{preset}} - 2^{\circ}\text{C}$, compressor stops operation and outdoor fan will stop 30s later. Indoor fan operates according to set fan speed.

③ When $T_{\text{preset}} - 2^{\circ}\text{C} < T_{\text{indoor ambient temperature}} < T_{\text{preset}}$, unit operates according to the previous status.

Under cooling mode, 4-way valve is not energized. Temperature setting range is $16 \sim 30^{\circ}\text{C}$. If compressor stops because of malfunction in cooling mode, indoor fan and swing motor will work according to the original status.

2. Drying mode

(1) Working condition and process of drying mode

① When $T_{\text{indoor ambient temperature}} > T_{\text{preset}}$, unit will be in drying mode. Outdoor fan and compressor start operation while indoor fan will operate at low fan speed.

② When $T_{\text{preset}} - 2^{\circ}\text{C} \leq T_{\text{indoor ambient temperature}} \leq T_{\text{preset}}$, unit operates according to the previous status.

③ When $T_{\text{indoor ambient temperature}} < T_{\text{preset}} - 2^{\circ}\text{C}$, compressor stops operation and outdoor fan will stop 30s later.

(2) Under drying mode, 4-way valve is not energized. Temperature setting range is $16 \sim 30^{\circ}\text{C}$.

(3) Protection function: same as in cooling mode.

3. Fan mode

(1) Under this mode, indoor fan can select different fan speed (except Turbo) or auto fan speed. Compressor, outdoor fan and 4-way valve all stop operation.

(2) In fan mode, temperature setting range is $16 \sim 30^{\circ}\text{C}$.

4. Heating mode

Working condition and process of heating mode:

① When $T_{\text{preset}} - (T_{\text{indoor ambient temperature}} - T_{\text{compensation}}) \geq 1^{\circ}\text{C}$, unit enters into heating mode. Compressor, outdoor fan and 4-way valve start operation.

② When $-2^{\circ}\text{C} < T_{\text{preset}} - (T_{\text{indoor ambient temperature}} - T_{\text{compensation}}) < 1^{\circ}\text{C}$, unit operates according to the previous status.

③ When $T_{\text{preset}} - (T_{\text{indoor ambient temperature}} - T_{\text{compensation}}) \leq -2^{\circ}\text{C}$, compressor stops operation and outdoor fan will stop 30s later. Indoor fan will be in residual-heat blowing status.

④ When unit is turned off under heating mode or changed to other modes from heating mode, 4-way valve will be power-off 2min after compressor stops working (compressor is in operation status under heating mode).

⑤ When $T_{\text{outdoor ambient temperature}} > 30^{\circ}\text{C}$, compressor stops operation immediately. Outdoor fan will stop 30s later.

⑥ Under the condition that compressor is turned on, when unit is changed to heating mode from cooling or drying mode, 4-way valve will be energized in 2~3mins delay.

Note: $T_{\text{compensation}}$ is determined by IDU and ODU. If IDU controls the compensation temperature, then $T_{\text{compensation}}$ is

determined according to the value sent by IDU to ODU; If IDU does not control the compensation temperature, then $T_{\text{compensation}}$ will default to 3°C by the ODU.

5. Freon recovery mode

After the Freon recovery signal from IDU is received, cooling at rated frequency will be forcibly turned on to recover Freon.

Indoor unit will display Fo. If any signal from remote controller is received, unit will exit from Freon recovery mode and indoor unit stops displaying Fo.

6. Compulsory defrosting

If unit is turned on under heating mode and set temperature is 16°C (by remote controller), press " $\Delta, \nabla, \Delta, \nabla, \Delta, \nabla$ " within 5s, unit will enter into compulsory defrosting mode and send the signal to ODU. When the compulsory defrosting signal from ODU is received, IDU will exit from the compulsory defrosting mode and stop sending the signal to ODU.

After ODU receives the compulsory defrosting code, it will start compulsory defrosting. Defrosting frequency and opening angle will be the same as in normal defrosting mode. When compulsory defrosting is finished, the complete unit resumes original status.

7. Auto mode

Auto mode is determined by controller of IDU. See IDU logic for details.

8. 8°C heating

Set temperature is 8°C . Display board of IDU displays 8°C . Under this mode, "Cold air prevention" function is shielded.

If compressor is operating under this mode, fan speed will adjust according to auto fan speed; if compressor stops operation under this mode, indoor fan will be in residual-heat blowing status.

When power on, communication light will be blinking in a normal way (after receiving a group of correct signals, blinking stops for 0.2s~0.3s). If there's no communication, communication light will be always on. If other ODU has malfunction, communication light will be on for 1s and off for 1s in a circular way.

7. Notes for Installation and Maintenance

Safety Precautions: Important!

Please read the safety precautions carefully before installation and maintenance.

The following contents are very important for installation and maintenance.

Please follow the instructions below.

- The installation or maintenance must accord with the instructions.
- Comply with all national electrical codes and local electrical codes.
- Pay attention to the warnings and cautions in this manual.
- All installation and maintenance shall be performed by distributor or qualified person.
- All electric work must be performed by a licensed technician according to local regulations and the instructions given in this manual.
- Be caution during installation and maintenance. Prohibit incorrect operation to prevent electric shock, casualty and other accidents.

WARNINGS

Electrical Safety Precautions:

1. Cut off the power supply of air conditioner before checking and maintenance.
2. The air condition must apply specialized circuit and prohibit share the same circuit with other appliances.
3. The air conditioner should be installed in suitable location and ensure the power plug is touchable.
4. Make sure each wiring terminal is connected firmly during installation and maintenance.
5. Have the unit adequately grounded. The grounding wire can't be used for other purposes.
6. Must apply protective accessories such as protective boards, cable-cross loop and wire clip.
7. The live wire, neutral wire and grounding wire of power supply must be corresponding to the live wire, neutral wire and grounding wire of the air conditioner.
8. The power cord and power connection wires can't be pressed by hard objects.
9. If power cord or connection wire is broken, it must be replaced by a qualified person.
10. If the power cord or connection wire is not long enough, please get the specialized power cord or connection wire from the manufacture or distributor. Prohibit prolong the wire by yourself.
11. For the air conditioner without plug, an air switch must

be installed in the circuit. The air switch should be all-pole parting and the contact parting distance should be more than 3mm.

12. Make sure all wires and pipes are connected properly and the valves are opened before energizing.
13. Check if there is electric leakage on the unit body. If yes, please eliminate the electric leakage.
14. Replace the fuse with a new one of the same specification if it is burnt down; Don't replace it with a cooper wire or conducting wire.
15. If the unit is to be installed in a humid place, the circuit breaker must be installed.

Installation Safety Precautions:

1. Select the installation location according to the requirement of this manual.(See the requirements in installation part)
2. Handle unit transportation with care; the unit should not be carried by only one person if it is more than 20kg.
3. When installing the indoor unit and outdoor unit, a sufficient fixing bolt must be installed; make sure the installation support is firm.
4. Ware safety belt if the height of working is above 2m.
5. Use equipped components or appointed components during installation.
6. Make sure no foreign objects are left in the unit after finishing installation.

Refrigerant Safety Precautions:

1. When refrigerant leaks or requires discharge during installation, maintenance, or disassembly, it should be handled by certified professionals or otherwise in compliance with local laws and regulations.
- 2.Avoid contact between refrigerant and fire as it generates poisonous gas; Prohibit prolong the connection pipe by welding.
3. Apply specified refrigerant only. Never have it mixed with any other refrigerant. Never have air remain in the refrigerant line as it may lead to rupture or other hazards.
4. Make sure no refrigerant gas is leaking out when installation is completed.
5. If there is refrigerant leakage, please take sufficient measure to minimize the density of refrigerant.
6. Never touch the refrigerant piping or compressor without wearing glove to avoid scald or frostbite.

Improper installation may lead to fire hazard, explosion, electric shock or injury.

Safety Precautions for Installing and Relocating the Unit:

To ensure safety, please be mindful of the following precautions.

WARNINGS

1. When installing or relocating the unit, be sure to keep the refrigerant circuit free from air or substances other than the specified refrigerant.

Any presence of air or other foreign substance in the refrigerant circuit will cause system pressure rise or compressor rupture, resulting in injury.

2. When installing or moving this unit, do not charge the refrigerant which is not comply with that on the nameplate or unqualified refrigerant.

Otherwise, it may cause abnormal operation, wrong action, mechanical malfunction or even series safety accident.

3. When refrigerant needs to be recovered during relocating or repairing the unit, be sure that the unit is running in cooling mode. Then, fully close the valve at high pressure side (liquid valve). About 30-40 seconds later, fully close the valve at low pressure side (gas valve), immediately stop the unit and disconnect power. Please note that the time for refrigerant recovery should not exceed 1 minute.

If refrigerant recovery takes too much time, air may be sucked in and cause pressure rise or compressor rupture, resulting in injury.

4. During refrigerant recovery, make sure that liquid valve and gas valve are fully closed and power is disconnected before detaching the connection pipe.

If compressor starts running when stop valve is open and connection pipe is not yet connected, air will be sucked in and cause pressure rise or compressor rupture, resulting in injury.

5. When installing the unit, make sure that connection pipe is securely connected before the compressor starts running.

If compressor starts running when stop valve is open and connection pipe is not yet connected, air will be sucked in and cause pressure rise or compressor rupture, resulting in injury.

6. Prohibit installing the unit at the place where there may be leaked corrosive gas or flammable gas.

If there leaked gas around the unit, it may cause explosion and other accidents.

7. Do not use extension cords for electrical connections. If the electric wire is not long enough, please contact a local service center authorized and ask for a proper electric wire.

Poor connections may lead to electric shock or fire.

8. Use the specified types of wires for electrical connections between the indoor and outdoor units. Firmly clamp the wires so that their terminals receive no external stresses.

Electric wires with insufficient capacity, wrong wire connections and insecure wire terminals may cause electric shock or fire.



R32 refrigerant warning

- To realize the function of the air conditioner unit, a special refrigerant circulates in the system. The used refrigerant is the fluoride R32, which is specially cleaned. The refrigerant is flammable and odorless. Furthermore, it can lead to explosion under certain conditions. But the flammability of the refrigerant is very low. It can be ignited only by fire.
- Compared to common refrigerants, R32 is a nonpolluting refrigerant with no harm to the ozone layer. The influence upon the greenhouse effect is also lower. R32 has got very good thermodynamic features which lead to a really high energy efficiency. The units therefore need a less filling.
- This product uses R32 difluoromethane refrigerant, which is a mildly flammable gas class A2L according to ISO 817 or ANSI/ASHRAE 34.
- "ANSI/ASHRAE 15 (USA) and CSA 852 (Canada)" stipulate that it must be handled by a refrigeration mechanic with an appropriate refrigerant handling licence.
- The appliance shall be stored in a room without continuously operating ignition sources. (for example: open flames, an operating gas appliance or an operating electric heater.)
- The appliance shall be stored in a well-ventilated area where the room size corresponds to the room area as specified for operation.
- The appliance shall be stored so as to prevent mechanical damage from occurring.
- Ducts connected to an appliance shall not contain an ignition source.
- Keep any required ventilation openings clear of obstruction.
- Do not pierce or burn.
- Be aware that refrigerants may not contain an odour.
- Do not use means to accelerate the defrosting process or to clean, other than those recommended by the manufacturer.
- Servicing shall be performed only as recommended by the manufacturer.
- Should repair be necessary, contact your nearest authorized
- Service Centre. Any repairs carried out by unqualified personnel may be dangerous.
- Compliance with national gas regulations shall be observed. Read specialist's manual.



- That pipe-work including piping material, pipe routing, and installation shall include protection from physical damage in operation and service, and be in compliance with national and local codes and standards, such as ASHRAE 15, ASHRAE 15.2, IAPMO Uniform Mechanical Code, ICC

International Mechanical Code, or CSA B52. All field joints shall be accessible for inspection prior to being covered or enclosed.

Notices for using refrigerant sensor

- Only applicable to refrigerant sensor models.
- The refrigerant sensor can monitor whether R32 refrigerant leaks in real time. When the leakage of R32 refrigerant is detected, the sensor will trigger the alarm and emit a buzzer, and the indoor unit will display "EA" code. Meanwhile, the outdoor unit will stop running.
- In case of refrigerant leakage, please open the window immediately for ventilation to reduce the concentration of refrigerant in the room. Meanwhile, check the room to ensure that there is no fire source. After completing the above operations, please leave the room and go to the safe place, and then contact the after-sales service team for maintenance.
- When the refrigerant sensor reaches its service life or is damaged, the indoor unit will display "FE" code. Please contact the after-sales service team to replace the refrigerant sensor.
- Avoid oil and water splashing into the refrigerant sensor, otherwise it may cause damage to the refrigerant sensor. Avoid using it in the environment with electromagnetic interference, chemical substances (such as chemical plants, etc.), flammable gas, combustible and explosive gas and smog, etc.
- Avoid using items containing ethanol (such as perfume, etc.) and smog-producing items (such as cigarettes, etc.) near the refrigerant sensor, otherwise it will lead to abnormal conditions such as false alarms of the refrigerant sensor. If such phenomenon occurs, please contact the after-sales service team for maintenance.

Safety Operation of Flammable Refrigerant

Aptitude requirement for maintenance man (repairs should be done only by specialists).

- Any person who is involved with working on or breaking into a refrigerant circuit should hold a current valid certificate from an industry-accredited assessment authority, which authorises their competence to handle refrigerants safely in accordance with an industry recognised assessment specification.
- Servicing shall only be performed as recommended by the equipment manufacturer. Maintenance and repair requiring the assistance of other skilled personnel shall be carried out under the supervision of the person competent in the use of flammable refrigerants

Safety preparation work

This product uses mildly flammable R32 refrigerant. Certain levels of refrigerant require minimum room sizes. Please ensure that these minimum room sizes are adhered to for standard installations. (Note: Please refer to the nameplate for the charging quantity of R32).

Appliance shall be installed, operated and stored in a room with a floor area larger than Xm^2 . (Please refer to table "a")

Table a - Minimum room area (m²)

Based on UL 60335-2-40 requirements
The following installation height and area for
customer reference.

Charge amount (kg)	Installation height(m)
	0 Minimum room area (m ²)
≤1.836	/
1.85	29.4
1.9	31.1
1.95	32.7
2	34.4
2.05	36.1
2.1	37.9
2.15	39.7
2.2	41.6
2.3	45.5
2.4	49.5
2.5	53.7
2.6	58.1
2.7	62.7
2.8	67.4
2.9	72.3
3	77.3
3.1	82.6
3.2	88.0
3.3	93.6
3.4	99.3
3.5	105.2

Information on servicing

Checks to the area

Prior to beginning work on systems containing FLAMMABLE REFRIGERANTS, Safety checks are necessary to ensure that the risk of ignition is minimised. For repair to the REFRIGERATING SYSTEM, the following precautions shall be completed prior to conducting work on the system.

Work procedure

Work shall be undertaken under a controlled procedure so as to minimise the risk of a flammable gas or vapour being present while the work is being performed.

General work area

All maintenance staff and others working in the local area shall be instructed on the nature of work being carried out. Work in confined spaces shall be avoided.

Checking for presence of refrigerant

The area shall be checked with an appropriate refrigerant detector prior to and during work, to ensure the technician is aware of potentially toxic or flammable atmospheres. Ensure that the leak detection equipment being used is suitable for use with all applicable refrigerants, i.e. non-sparking, adequately sealed or intrinsically safe.

Presence of fire extinguisher

If any hot work is to be conducted on the refrigerating equipment or any associated parts, appropriate fire extinguishing equipment shall be available to hand. Have a dry powder or CO₂ fire extinguisher adjacent to the charging area.

No ignition sources

No person carrying out work in relation to a REFRIGERATING SYSTEM which involves exposing any pipe work shall use any sources of ignition in such a manner that it may lead to the risk of fire or explosion. All possible ignition sources, including cigarette smoking, should be kept sufficiently far away from the site of installation, repairing, removing and disposal, during which refrigerant can possibly be released to the surrounding space. Prior to work taking place, the area around the equipment is to be surveyed to make sure that there are no flammable hazards or ignition risks. "No Smoking" signs shall be displayed.

Ventilated area

Ensure that the area is in the open or that it is adequately ventilated before breaking into the system or conducting any hot work. A degree of ventilation shall continue during the period that the work is carried out. The ventilation should safely disperse any released refrigerant and preferably expel it externally into the atmosphere.

Checks to the refrigerating equipment

Where electrical components are being changed, they shall be fit for the purpose and to the correct specification. At all times the manufacturer's maintenance and service guidelines shall be followed. If in doubt, consult the manufacturer's technical department for assistance.

The following checks shall be applied to installations using FLAMMABLE REFRIGERANTS:

- the actual REFRIGERANT CHARGE is in accordance with the room size within which the refrigerant containing parts are installed.
- the ventilation machinery and outlets are operating adequately and are not obstructed;
- if an indirect refrigerating circuit is being used, the secondary circuit shall be checked for the presence of refrigerant;
- marking to the equipment continues to be visible and legible. Markings and signs that are illegible shall be corrected.
- refrigerating pipe or components are installed in a position where they are unlikely to be exposed to any substance which may corrode refrigerant containing components, unless the components are constructed of materials which are inherently resistant to being corroded or are suitably protected against being so corroded.

Checks to electrical devices

Repair and maintenance to electrical components shall include initial safety checks and component inspection procedures. If a fault exists that could compromise safety, then no electrical supply shall be connected to the circuit until it is satisfactorily dealt with. If the fault cannot be corrected immediately but it is necessary to continue operation, an adequate temporary solution shall be used. This shall be reported to the owner of the equipment so all parties are advised.

Initial safety checks shall include:

- that capacitors are discharged: this shall be done in a safe manner to avoid possibility of sparking;
- that no live electrical components and wiring are exposed while charging, recovering or purging the system;
- that there is continuity of earth bonding.

Repairs to sealed components

Sealed electrical components shall be replaced.

Repair to intrinsically safe components

Intrinsically safe components must be replaced.

Cabling

Check that cabling will not be subject to wear, corrosion, excessive pressure, vibration, sharp edges or any other adverse environmental effects. The check shall also take into account the effects of aging or continual vibration from sources such as compressors or fans.

Detection of flammable refrigerants

Under no circumstances shall potential sources of ignition be used in the searching for or detection of refrigerant leaks. A halide torch (or any other detector using a naked flame) shall not be used.

The following leak detection methods are deemed acceptable for all refrigerant systems.

Electronic leak detectors may be used to detect refrigerant leaks but, in the case of FLAMMABLE REFRIGERANTS, the sensitivity may not be adequate, or may need re-calibration. (Detection equipment shall be calibrated in a refrigerant-free area.) Ensure that the detector is not a potential source of ignition and is suitable for the refrigerant used. Leak detection equipment shall be set at a percentage of the LFL of the refrigerant and shall be calibrated to the refrigerant employed, and the appropriate percentage of gas (25% maximum) is confirmed.

Leak detection fluids are also suitable for use with most refrigerants but the use of detergents containing chlorine shall be avoided as the chlorine may react with the refrigerant and corrode the copper pipe-work.

NOTE Examples of leak detection fluids are

- bubble method,
- fluorescent method agents

If a leak is suspected, all naked flames shall be removed/ extinguished.

If a leakage of refrigerant is found which requires brazing, all of the refrigerant shall be recovered from the system, or isolated (by means of shut off valves) in a part of the system remote from the leak. Removal of refrigerant shall be according to Clause "Removal and evacuation".

Removal and evacuation

When breaking into the refrigerant circuit to make repairs -or for any other purpose -conventional procedures shall be used. However, for flammable refrigerants it is important that best practice be followed, since flammability is a consideration. The following procedure shall be adhered to:

- Safely remove refrigerant following local and national regulations;
- evacuate;
- purge the circuit with inert gas (optional for A2L);
- evacuate (optional for A2L);
- continuously flush or purge with inert gas when using flame to open circuit; and
- open the circuit.

The refrigerant charge shall be recovered into the correct recovery cylinders if venting is not allowed by local and national codes. For appliances containing flammable refrigerants, the system shall be purged with oxygen-free nitrogen to render the appliance safe for flammable refrigerants. This process might need to be repeated several times. Compressed air or oxygen shall not be used for purging refrigerant systems.

For appliances containing flammable refrigerants, refrigerant purging shall be achieved by breaking the vacuum in the system with oxygen-free nitrogen and continuing to fill until the working pressure is achieved, then venting to atmosphere, and finally pulling down to a vacuum (optional for A2L). This process shall be repeated until no refrigerant is within the system (optional for A2L). When the final oxygen-free nitrogen charge is used, the system shall be vented down to atmospheric pressure to enable work to take place.

The outlet for the vacuum pump shall not be close to any potential ignition sources, and ventilation shall be available

Charging procedures

In addition to conventional charging procedures, the following requirements shall be followed.

- Ensure that contamination of different refrigerants does not occur when using charging equipment.
- Hoses or lines shall be as short as possible to minimise the amount of refrigerant contained in them.
- Cylinders shall be kept in an appropriate position according to the instructions.
- Ensure that the REFRIGERATING SYSTEM is earthed prior to charging the system with refrigerant.
- Label the system when charging is complete (if not already).
- Extreme care shall be taken not to overfill the REFRIGERATING SYSTEM.

Prior to recharging the system, it shall be pressure-tested with the appropriate purging gas. The system shall be leak-tested on completion of charging but prior to commissioning. A follow up leak test shall be carried out prior to leaving the site.

Decommissioning

Before carrying out this procedure, it is essential that the technician is completely familiar with the equipment and all its detail. It is recommended good practice that all refrigerants are recovered safely. Prior to the task being carried out, an oil and refrigerant sample shall be taken in case analysis is required prior to re-use of recovered refrigerant. It is essential that electrical power is available before the task is commenced.

- a) Become familiar with the equipment and its operation.
- b) Isolate system electrically
- c) Before attempting the procedure, ensure that:
 - mechanical handling equipment is available, if required, for handling refrigerant cylinders;
 - all personal protective equipment is available and being used correctly;
 - the recovery process is supervised at all times by a competent person;
 - recovery equipment and cylinders conform to the appropriate standards.
- d) Pump down refrigerant system, if possible
- e) If a vacuum is not possible, make a manifold so that refrigerant can be removed from various parts of the system.
- f) Make sure that cylinder is situated on the scales before recovery takes place
- g) Start the recovery machine and operate in accordance with instructions
- h) Do not overfill cylinders (no more than 80 % volume liquid charge).
- i) Do not exceed the maximum working pressure of the cylinder even temporarily.
- j) When the cylinders have been filled correctly and the process completed, make sure that the cylinders and the equipment are removed from site promptly and all isolation valves on the equipment are closed off.
- k) Recovered refrigerant shall not be charged into another REFRIGERATING SYSTEM unless it has been cleaned and checked.

Labelling

Equipment shall be labelled stating that it has been decommissioned and emptied of refrigerant. The label shall be dated and signed. For appliances containing FLAMMABLE REFRIGERANTS, ensure that there are labels on the equipment stating the equipment contains FLAMMABLE REFRIGERANT.

Recovery

When removing refrigerant from a system, either for servicing or decommissioning, it is recommended good practice that all refrigerants are removed safely.

When transferring refrigerant into cylinders, ensure that only appropriate refrigerant recovery cylinders are employed. Ensure that the correct number of cylinders for holding the total system

charge is available. All cylinders to be used are designated for the recovered refrigerant and labelled for that refrigerant (i.e. special cylinders for the recovery of refrigerant). Cylinders shall be complete with pressure-relief valve and associated shut-off valves in good working order. Empty recovery cylinders are evacuated and, if possible, cooled before recovery occurs.

The recovery equipment shall be in good working order with a set of instructions concerning the equipment that is at hand and shall be suitable for the recovery of the flammable refrigerant. If in doubt, the manufacturer should be consulted. In addition, a set of calibrated weighing scales shall be available and in good working order. Hoses shall be complete with leak-free disconnect couplings and in good condition.

The recovered refrigerant shall be processed according to local legislation in the correct recovery cylinder, and the relevant waste transfer note arranged. Do not mix refrigerants in recovery units and especially not in cylinders.

If compressors or compressor oils are to be removed, ensure that they have been evacuated to an acceptable level to make certain that flammable refrigerant does not remain within the lubricant. The compressor body shall not be heated by an open flame or other ignition sources to accelerate this process. When oil is drained from a system, it shall be carried out safely.

Main Tools for Installation and Maintenance



Level meter



Measuring tape



Screw driver



Impact drill



Drill head



Electric drill



Electroprobe



Universal meter



Torque wrench



Open-end wrench



Inner hexagon spanner



Electronic leakage detector



Vacuum pump



Pressure meter



Pipe pliers



Pipe pliers



Pipe cutter



Pipe expander



Pipe bender



Soldering appliance



Refrigerant container



Electronic scale

8. Installation

8.1 Installation Dimension Diagram

36K

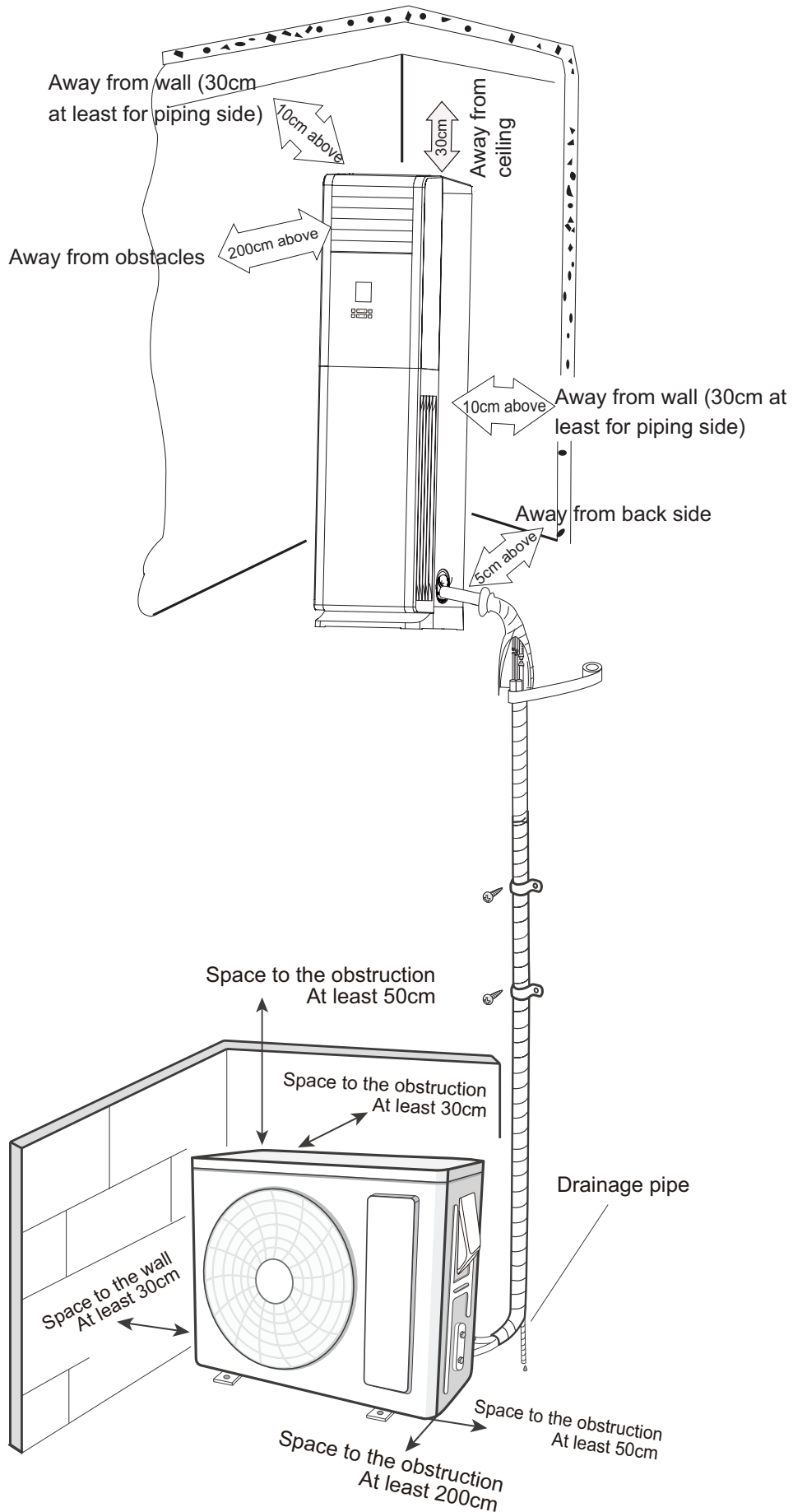

Installation Procedures

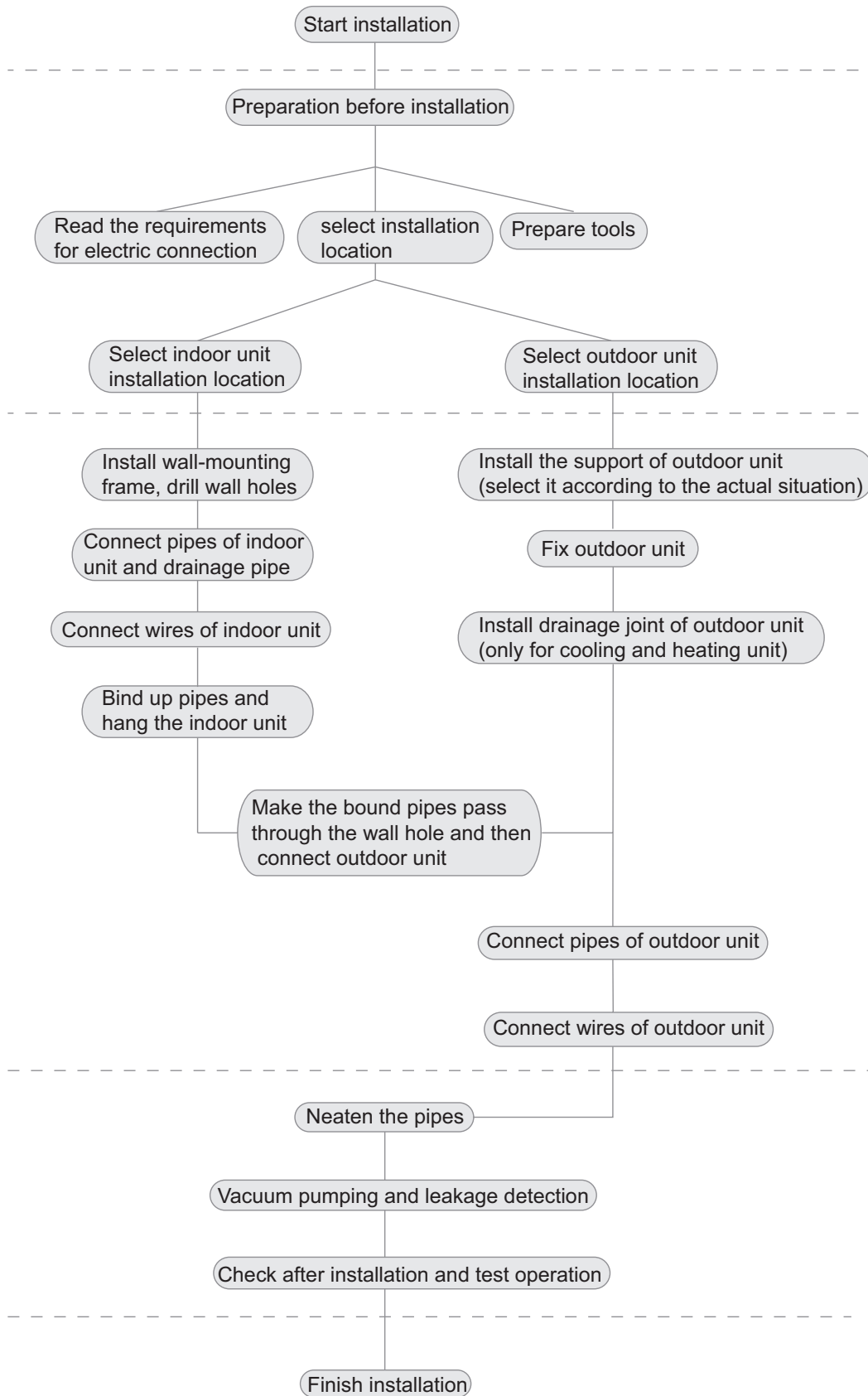

Note: this flow is only for reference; please find the more detailed installation steps in this section.

8.2 Installation Parts-checking

No.	Name
1	Indoor unit
2	Outdoor unit
3	Connection pipe
4	Drainage pipe
5	Connecting cable(power cord)
6	Wall pipe
7	Sealing gum
8	Wrapping tape
9	Support of outdoor unit
10	Fixing screw
11	Drainage plug(cooling and heating unit)
12	Owners manual, remote controller

⚠ Note:

1. Please contact the local agent for installation.
2. Don't use unqualified power cord.

8.3 Selection of Installation Location

1. Basic Requirement:

Installing the unit in the following places may cause malfunction. If it is unavoidable, please consult the local dealer:

1. The place with strong heat sources, vapors, flammable or explosive gas, or volatile objects spread in the air.
2. The place with high-frequency devices (such as welding machine, medical equipment).
3. The place near coast area.
4. The place with oil or fumes in the air.
5. The place with sulfureted gas.
6. Other places with special circumstances.
7. The appliance shall not be installed in the laundry.
8. It's not allowed to be installed on the unstable or motive base structure (such as truck) or in the corrosive environment (such as chemical factory).

2. Indoor Unit:

1. Avoid installing the indoor unit in a place where generated or leaked inflammable gas will stay.
2. Avoid installing the indoor unit in a moist place or in a place where oil may be splashed on the unit.
3. Select a location where outlet air may reach each corner of the room.
4. Select a location where connection pipe can be led to outdoor conveniently.
5. Select a location where air inlet and outlet won't be blocked.
6. Select a location with least affection of outdoor air.
7. Select a location with firm and flat floor.
8. Retain sufficient space for maintenance and installation.
9. Ensure the installation meets the requirement of installation dimension diagram.
10. Do not use the unit in the immediate surroundings of a laundry, a bath, a shower or a swimming pool.

3. Outdoor Unit:

1. Select a location where the noise and outflow air emitted by the outdoor unit will not affect neighborhood.
2. The location should be well ventilated and dry, in which the outdoor unit won't be exposed directly to sunlight or strong wind.
3. The location should be able to withstand the weight of outdoor unit.
4. Make sure that the installation follows the requirement of installation dimension diagram.
5. Select a location which is out of reach for children and far away from animals or plants. If it is unavoidable, please add fence for safety purpose.
6. The height difference between indoor unit and outdoor unit should be within 5m. The length of connection pipe should be within 10m.

8.4 Electric Connection Requirement

1. Safety Precaution

1. Must follow the electric safety regulations when installing the unit.
2. If the supply cord is damaged, it must be replaced by the manufacturer or its service agent or a similarly qualified person in order to avoid a hazard.
3. According to the local safety regulations, use qualified power supply circuit and air switch
4. A air switch having a contact separation of at least 3mm in all poles should be fixed in fixed wiring.
5. The appliance shall be installed in accordance with national wiring regulation.
6. The air switch must have the functions of magnetic tripping and heat tripping in order to prevent short circuit or overload. Please install the air switch with suitable capacity according to the sheet below.
7. Make sure the power supply matches with the requirement of air conditioner. Unstable power supply or incorrect wiring may result in electric shock, fire hazard or malfunction. Please install proper power supply cables before using the air conditioner.
8. Properly connect the live wire, neutral wire and grounding wire of power socket.
9. Be sure to cut off the power supply before proceeding any work related to electric safety.
10. Do not put through the power before finishing installation.

2. Grounding Requirement:

1. The air conditioner is first class electric appliance. It must be properly grounded with specialized grounding device by a professional. Please make sure it is always grounded effectively, otherwise it may cause electric shock.
2. The yellow-green wire in air conditioner is grounding wire, which can't be used for other purposes.
3. The grounding resistance should comply with national electric safety regulations.
4. Including an air switch with suitable capacity, please note the following table. Air switch should be included magnet buckle and heating buckle function, it can protect the circuit-short and overload. (Caution: please do not use the fuse only for protect the circuit)

Air-conditioner	Specification of connection wires for indoor units and outdoor units	Power cord
36K	4×AWG14	3XAWG12

8.5 Installation of Indoor Unit

1. Choosing Installation location

Recommend the installation location to the client and then confirm it with the client.

2. Open piping hole

(1) Choose the position of piping hole according to the direction of outlet pipe.

(2) Open a piping hole with the diameter of $\Phi 70$ on the selected outlet pipe position. In order to drain smoothly, slant the piping hole on the wall slightly downward to the outdoor side with the gradient of $5-10^\circ$. (As show in Fig.1)

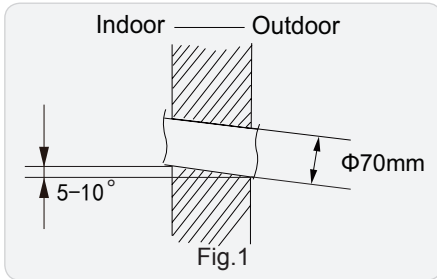

⚠ Note:

Pay attention to dust prevention and take relevant safety measures when opening the hole.

3. Outlet Pipe

(1) The pipe can be led out in the direction of left, right or rear. (As show in Fig.2)

(2) After confirming the direction of outlet pipe, loosen the screws at the upper and lower adjusting baffle to let the connection pipe/drain pipe connects the indoor unit. (As show in Fig.3)

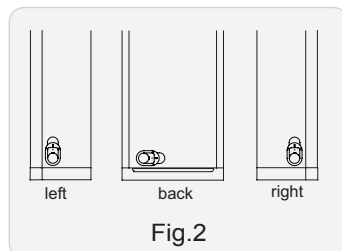

Fig.2

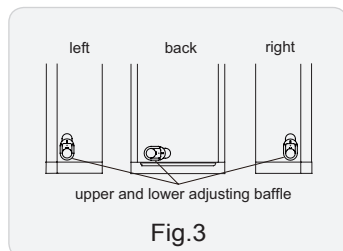

Fig.3

4. Connect the Pipe of Indoor Unit

(1) Take out the left and right screw cover and then remove the screws on air-inlet panel, push the front door plate upwards and then separate the connector connected to the connection wire of display and then remove the front door plate sub-assy. Remove two screws on the air-in panel sub-assy. Open the air-in panel along the arrow direction and then remove the air-in panel sub-assy.(As show in Fig.4)

(2) Aim the pipe joint at the corresponding bellmouth.(As show in Fig.5)

(3) Pretightening the union nut with hand.

(4) Adjust the torque force by referring to the following sheet. Place the open-end wrench on the pipe joint and place the torque wrench on the union nut. Tighten the union nut with torque wrench.(As show in Fig.6)

(5) Wrap the indoor pipe and joint of connection pipe with insulating pipe, and then wrap it with tape. (As show in Fig.7)

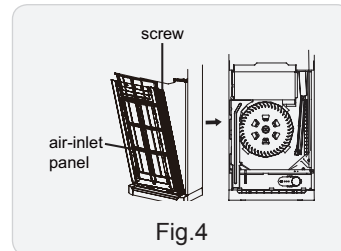

Fig.4

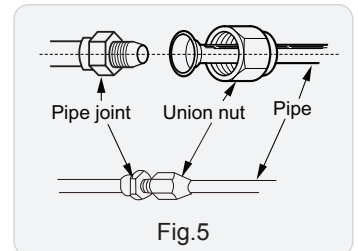

Fig.5

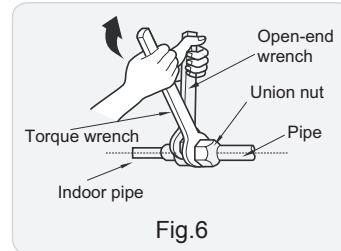

Fig.6

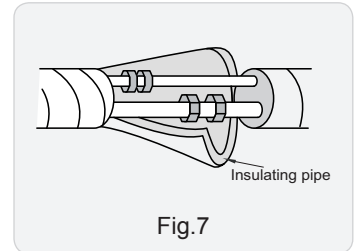

Fig.7

Refer to the following table for wrench moment of force:

Piping size (inch)	Tightening torque (ft-lb)
1/4	11-14
3/8	25-29
1/2	33-36
5/8	44-47
3/4	51-55

5. Install Drain Hose

(1) Connect the drain hose to the outlet pipe of indoor unit.(As show in Fig.8)

(2) Bind the joint with tape.(As show in Fig.8)

(3) Add insulating pipe in the indoor drain hose in order to prevent condensation.(As show in Fig.10)

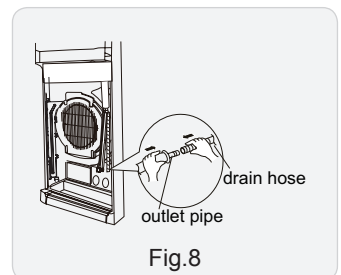

Fig.8

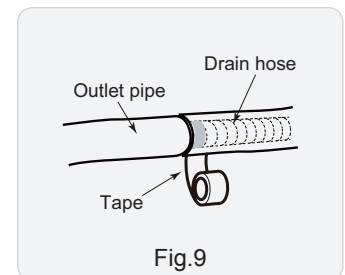

Fig.9

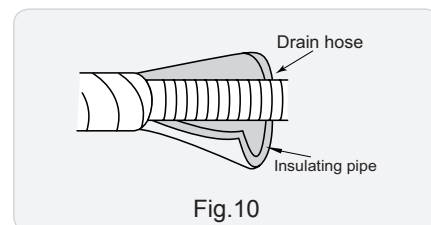

Fig.10

6. Connect Wire of Indoor Unit

(1) Make the power connection wire go through the cablecross hole of indoor unit(As show in Fig.11)

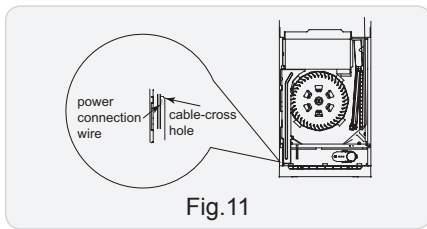

Fig.11

(2) Remove the wire clip; connect the power connection wire to the wiring terminal according to the color; tighten the screw and then fix the power supply wire, power connection wire with wire clip. (As show in Fig.12)

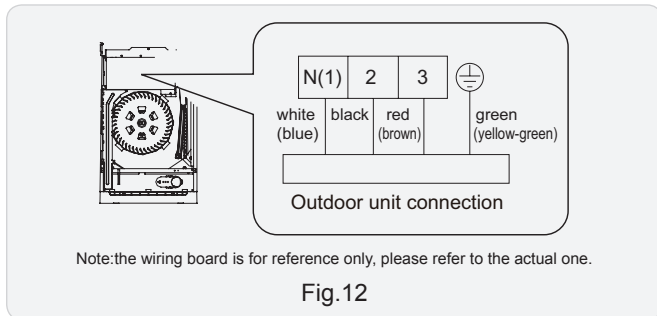

Fig.12

(3) Adjust the position of upper and lower adjusting baffle; clamp the connection pipe and drain pipe as firm as possible.
(4) Tighten the screws.

⚠ Note:

- (1) All wires of indoor unit and outdoor unit should be connected by a professional.
- (2) If the length of power connection wire is insufficient, please contact the supplier for a new one. Avoid extending the wire by yourself.
- (3) For the air conditioner with plug, the plug should be reachable after finishing installation.
- (4) For the air conditioner without plug, an air switch must be installed in the line. The air switch should be all-pole parting and the contact parting distance should be more than 3mm.

7. Bind up Pipe

- (1) Bind up the connection pipe, power cord and drain hose with the band. (As show in Fig.13)
- (2) Reserve a certain length of drain hose and power cord for installation when binding them. When binding to a certain degree, separate the indoor power and then separate the drain hose. (As show in Fig.14)
- (3) Bind them evenly.
- (4) The liquid pipe and gas pipe should be bound separately at the end.

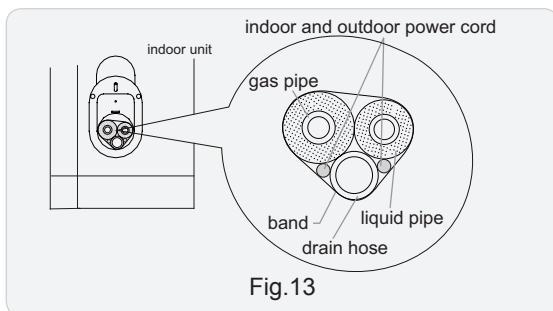

Fig.13

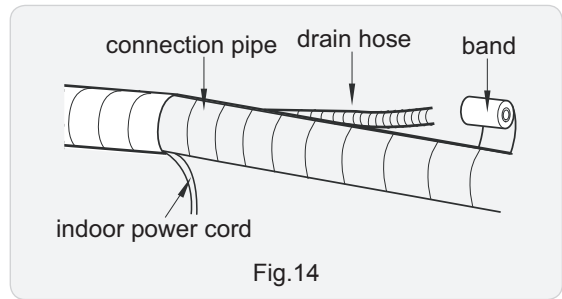

Fig.14

⚠ Note:

- (1) The power cord and control wire can't be crossed or winding.
- (2) The drain hose should be bound at the bottom.

8. Hang the Indoor Unit

- (1) Put the bound pipes in the wall pipe and then make them pass through the wall hole.
- (2) Stuff the gap between pipes and wall hole with sealing gum. (As show in Fig.15)
- (3) Fix the wall pipe.
- (4) Check if the indoor unit is installed firmly.

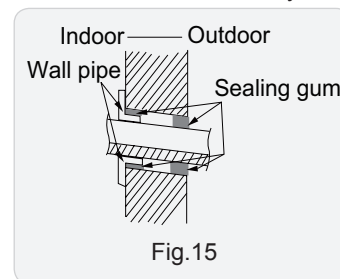

Fig.15

⚠ Note:

Do not bend the drain hose too excessively in order to prevent blocking.

8.6 Installation of Outdoor Unit

1. Fix the Support of Outdoor Unit (Select it according to the actual installation situation)

- (1) Select installation location according to the house structure.
- (2) Fix the support of outdoor unit on the selected location with expansion screws.

⚠ Note:

- (1) Take sufficient protective measures when installing the outdoor unit.
- (2) Make sure the support can withstand at least four times the unit weight.
- (3) The outdoor unit should be installed at least 3cm above the floor in order to install drain joint. (As show in Fig.16)
- (4) For the unit with cooling capacity of 2300W~5000W, 6 expansion screws are needed; for the unit with cooling capacity of 6000W~8000W, 8 expansion screws are needed; for the unit with cooling capacity of 10000W~16000W, 10 expansion screws are needed.

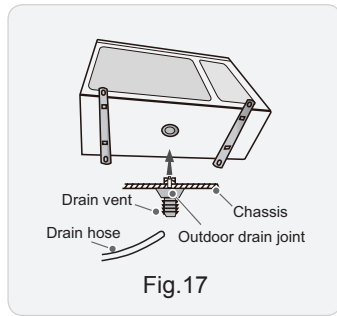
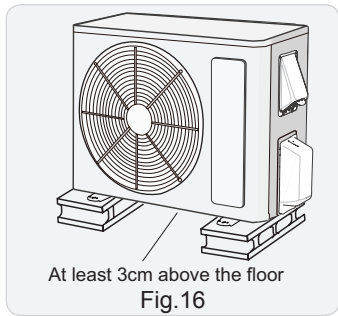

2. Install Drain Joint(Only for cooling and heating unit)

- (1) Connect the outdoor drain joint into the hole on the chassis.
 - (2) Connect the drain hose into the drain vent.
- (As show in Fig.17)

3. Fix Outdoor Unit

- (1) Place the outdoor unit on the support.
 - (2) Fix the foot holes of outdoor unit with bolts.
- (As show in Fig.18)

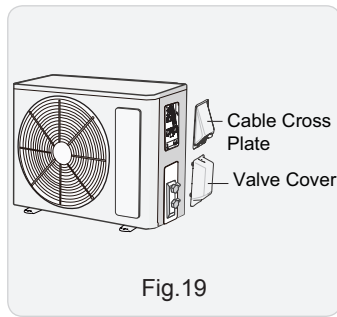
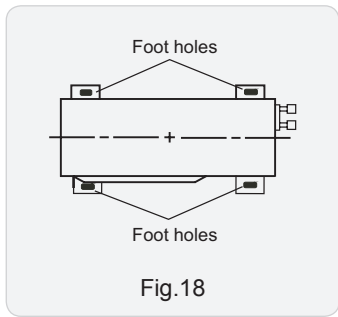

4. Connect Indoor and Outdoor Pipes

- (1) Remove the screw on the valve cover of outdoor unit and then remove the valve cover.(As show in Fig.19)
- (2) Remove the screw cap of valve and aim the pipe joint at the bellmouth of pipe.(As show in Fig.20)

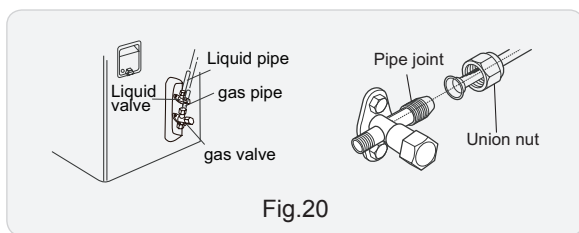

- (3) Pretightening the union nut with hand.
- (4) Tighten the union nut with torque wrench by referring to the sheet below.

Refer to the following table for wrench moment of force :

Piping size (inch)	Tightening torque (ft-lb)
1/4	11-14
3/8	25-29
1/2	33-36
5/8	44-47
3/4	51-55

5. Connect Outdoor Electric Wire

- (1) Remove the wire clip; connect the power connection wire to the wiring terminal according to the color; fix them with screws.
- (As show in Fig.21)

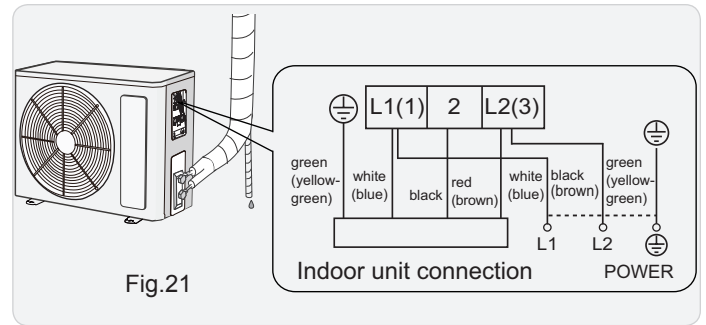

Note: the wiring connect is for reference only,please refer to the actual one.

⚠ CAUTION

- (1) After tightening the screw, pull the power supply cord slightly to check if it is firm.
- (2) Never cut the power connection wire to prolong or shorten the distance.
- (3)The power connection wire and connection pipe can't touch each other.
- (4)Top cover of outdoor unit and electric box assembly should be fixed by the screw. Otherwise, it can cause a fire,or short circuit caused by water or dust.
- (5) For the air conditioner without plug, an air switch must be installed in the line. The air switch should be all-pole parting and the contact parting distance should be more than 3mm.

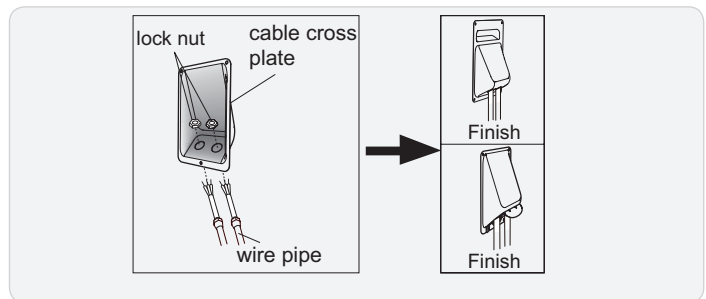

⚠ Note:

- (1) After tightening the screw, pull the power cord slightly to check if it is firm.
- (2) Never cut the power connection wire to prolong or shorten the distance.

6. Neaten the Pipes

- (1) The pipes should be placed along the wall, bent reasonably and hidden possibly. Min. semidiameter of bending the pipe is 10cm.
- (2) If the outdoor unit is higher than the wall hole, you must set a U-shaped curve in the pipe before pipe goes into the room, in order to prevent rain from getting into the room.(As show in Fig.23)

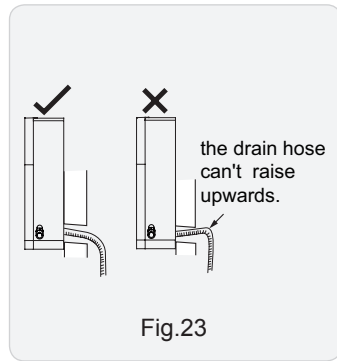
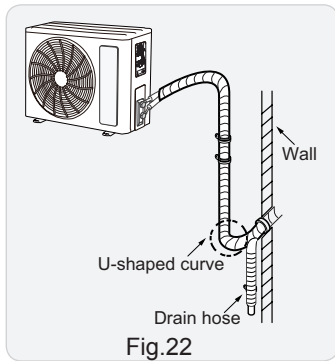

⚠ Note:

- (1) The through-wall height of drain hose shouldn't be higher than the outlet pipe hole of indoor unit.(As show in Fig.23)
- (2) Slant the drain hose slightly downwards. The drain hose can't be curved, raised and fluctuant, etc. (As show in Fig.24)
- (3) The water outlet can't be placed in water in order to drain smoothly.(As show in Fig.25)

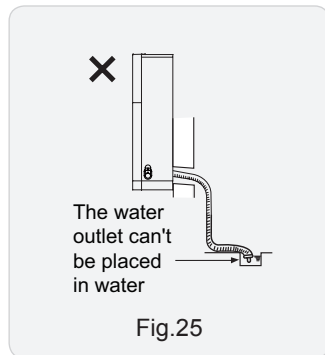
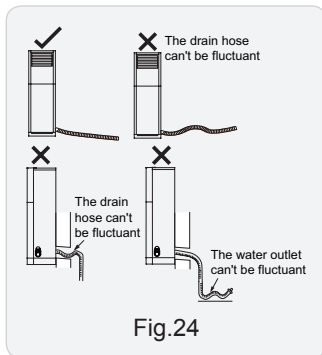

8.7 Vacuum Pumping and Leak Detection

1. Use Vacuum Pump

- (1) Remove the valve caps on the liquid valve and gas valve and the nut of refrigerant charging vent.
- (2) Connect the charging hose of piezometer to the refrigerant charging vent of gas valve and then connect the other charging hose to the vacuum pump.
- (3) Open the piezometer completely and operate for 10-15min to check if the pressure of piezometer remains in -0.1MPa.
- (4) Close the vacuum pump and maintain this status for 1-2min to check if the pressure of piezometer remains in -0.1MPa. If the pressure decreases, there may be leakage.
- (5) Remove the piezometer, open the valve core of liquid valve and gas valve completely with inner hexagon spanner.
- (6) Tighten the screw caps of valves and refrigerant charging vent. (As show in Fig.26)

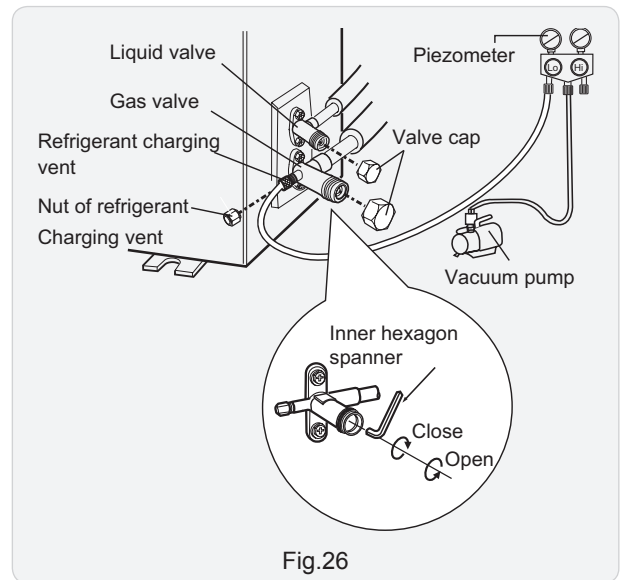

2. Leakage Detection

- (1) With leakage detector:
Check if there is leakage with leakage detector.
- (2) With soap water:
If leakage detector is not available, please use soap water for leakage detection. Apply soap water at the suspected position and keep the soap water for more than 3min. If there are air bubbles coming out of this position, There's a leakage.

8.8 Check after Installation and Test Operation

1. Check after Installation

Check according to the following requirement after finishing installation.

NO.	Items to be checked	Possible malfunction
1	Has the unit been installed firmly?	The unit may drop, shake or emit noise.
2	Have you done the refrigerant leakage test?	It may cause insufficient cooling (heating) capacity.
3	Is heat insulation of pipeline sufficient?	It may cause condensation and water dripping.
4	Is water drained well?	It may cause condensation and water dripping.
5	Is the voltage of power supply according to the voltage marked on the nameplate?	It may cause malfunction or damage the parts.
6	Is electric wiring and pipeline installed correctly?	It may cause malfunction or damage the parts.
7	Is the unit grounded securely?	It may cause electric leakage.
8	Does the power cord follow the specification?	It may cause malfunction or damage the parts.
9	Is there any obstruction in air inlet and air outlet?	It may cause insufficient cooling (heating) capacity.
10	The dust and sundries caused during installation are removed?	It may cause malfunction or damaging the parts.
11	The gas valve and liquid valve of connection pipe are open completely?	It may cause insufficient cooling (heating) capacity.
12	Is the inlet and outlet of piping hole been covered?	It may cause insufficient cooling(heating) capacity or waster eletricity.

2. Test Operation

(1) Preparation of test operation

- The client approves the air conditioner installation.
- Specify the important notes for air conditioner to the client.

(2) Method of test operation

- Put through the power, press ON/OFF button on the remote controller to start operation.
- Press MODE button to select AUTO, COOL, DRY, FAN and HEAT to check whether the operation is normal or not.
- If the ambient temperature is lower than 16°C , the air conditioner can't start cooling.

9. Maintenance

9.1 Error Code List

Error code	Malfunction name	AC status	Possible causes
C5	Malfunction of jumper cap	The complete unit stops operation	<ol style="list-style-type: none"> 1. Jumper cap is not installed in control panel; 2. Poor contact of jumper cap; 3. Jumper cap is damaged; 4. The tested circuit of jumper cap on control panel is abnormal.
E6	Communication malfunction between indoor unit and outdoor unit	Cool: compressor stops operation, while indoor fan operates; Heat: all loads stops operation.	See "Communication malfunction"
H5	IPM protection	Cool/Dry: compressor stops operation, while indoor fan operates. Heat: all loads stops operation.	See "IPM protection, over-phase current of compressor"
L3 LA	Malfunction of outdoor fan/ malfunction of DC motor	Cool/Dry: all loads stops operation except indoor fan. Heat: all loads stops operation.	<ol style="list-style-type: none"> 1. Outdoor condenser, air inlet and air outlet are blocked by filth or dirt; 2. Fan is blocked or loosened; 3. Motor or connection wire of motor is damaged; 4. Main board of outdoor unit is damaged; (As for dual-outdoor fan, L3 indicates fan 1; LA indicates fan 2)
H3	Overload protection of compressor	Cool/Dry: compressor stops operation, while indoor fan operates. Heat: all loads stops operation.	<ol style="list-style-type: none"> 1. Overload wire of compressor is loose; 2. The overload protector is damaged. Under normal circumstances, the resistance between both ends of terminal is less than 1ohm. 3. See "Overload protection of compressor , High discharge temperature protection of compressor"
F0	Refrigerant insufficient protection, cut-off protection of refrigerant	Cool: compressor and outdoor fan stops operation, while indoor fan operates; Heat: Compressor, outdoor fan and indoor fan stops operation.	<ol style="list-style-type: none"> 1. Is system cooling under high humidity environment, thus temperature difference of heat transfer is small; 2. Check whether the big valve and small valve of outdoor unit are opened completely; 3. Is the temperature sensor of evaporator of indoor unit loose? 4. Is the temperature sensor of condenser of outdoor unit loose? 5. Is the capillary or the electronic expansion valve blocked? 6. Is refrigerant leaking?
F1	Indoor ambient temperature sensor is open/short-circuited	Cool/Dry: indoor fan operates, while compressor and outdoor fan stops operation; Heat: all loads stops operation.	<ol style="list-style-type: none"> 1. Temperature sensor is not well connected; 2. Temperature sensor is damaged 3. Main board of indoor unit is damaged.
F2	Indoor evaporator temperature sensor is open/short-circuited	Cool/Dry: indoor fan operates, while compressor and outdoor fan stops operation; Heat: all loads stops operation.	<ol style="list-style-type: none"> 1. Temperature sensor is not well connected; 2. Temperature sensor is damaged 3. Main board of indoor unit is damaged.
H6	No feedback from indoor unit's motor	The complete unit stops operation	<ol style="list-style-type: none"> 1. Is the fan blocked? 2. Is the motor terminal loose? 3. Is the connection wire of motor damaged? 4. Is the motor damaged? 5. Is the main board of indoor unit damaged?
LP	Indoor unit and outdoor can be matched with each other	Heat: compressor, outdoor unit and indoor fan stops operation.	Capacity of indoor unit and outdoor unit can't be matched.
C4	Malfunction of jumper cap of outdoor unit	Heat: all loads are stopped; other modes: outdoor unit stops operation.	Jumper cap of outdoor unit hasn't been installed.
b7	Gas valve temperature sensor is ON / short-circuited		<ol style="list-style-type: none"> 1. Temperature sensor is not well connected or damaged; 2. The wire of temperature sensor is damaged, causing short circuit to copper pipe or outer casing; 3. Main board of outdoor unit is damaged.

Error code	Malfunction name	AC status	Possible causes
b5	Liquid valve temperature sensor is ON / short-circuited		<ol style="list-style-type: none"> 1. Temperature sensor is not well connected or damaged; 2. The wire of temperature sensor is damaged, causing short circuit to copper pipe or outer casing; 3. Main board of outdoor unit is damaged.
E1	High pressure protection of system	Cool/Dry: all loads stops operation except indoor fan; Heat: all loads stops operation.	<ol style="list-style-type: none"> 1. Heat exchange of outdoor unit is too dirty, or it blocked the air inlet/outlet; 2. Is power voltage normal; (three-phase unit) 3. Ambient temperature is too high; 4. Wiring of high pressure switch is loose or high pressure switch is damaged; 5. The internal system is blocked; (dirt blockage, ice blockage, oil blockage, angle valve is not completely opened) 6. Main board of outdoor unit is damaged; 7. Refrigerant is too much.
E3	Low pressure/low system pressure protection/ compressor low pressure protection	Cool: compressor, outdoor fan and indoor fan stop operation; Heat: compressor and outdoor fan stop operation at first. About 1min later, indoor fan stops operation; 2mins later, the 4-way valve stop operation.	<ol style="list-style-type: none"> 1. Low pressure switch is damaged; 2. Refrigerant inside the system is insufficient.
E4	High discharge temperature protection of compressor	Cool/Dry: compressor and outdoor fan stops operation, while indoor fan operates; Heat: all loads stops operation.	See "Overload protection of compressor , High discharge temperature protection of compressor"
E5	AC overcurrent protection	Cool/Dry: compressor and outdoor fan stops operation, while indoor fan operates; Heat: all loads stops operation.	<ol style="list-style-type: none"> 1. Power voltage is unstable; 2. Power voltage is too low; 3. System load is too high, which leads to high current; 4. Heat exchange of indoor unit is too dirty, or it blocked the air inlet/outlet; 5. Fan motor operation is abnormal; the fan speed is too low or not functioning; 6. Compressor is blocked; 7. The internal system is blocked; (dirt blockage, ice blockage, oil blockage, angle valve is not completely opened) 8. Main board of outdoor unit is damaged. See "AC overcurrent protection"
E7	Mode shock/sysmte mode shock	Load of indoor unit stops operation (indoor fan, E-heater, swing)	Malfunction of one-to-more system; there may be two indoor units which has set the shock mode, such as one is cooling and the other is heating.
E8	High temperature prevention protection	Cool: compressor stops operation while indoor fan operates; Heat: all loads stops operation.	See "High temperature prevention protection; high power; system isabnormal"
EE	Malfunction of EEPROM	Cool/Dry: compressor stops operation, while indoor fan operates; Heat: all loads stops operation.	Main board of outdoor unit is damaged.
F0	Refrigerant-recovery mode	Cool/Dry: compressor and outdoor fan stops operation, while indoor fan operates.	Refrigerant recovery. The maintenance personnel operate it when he is maintaining the unit.
F3	Outdoor ambient temperature is open/short-circuited	Cool/Dry: compressor and outdoor fan stop operation, while indoor fan operates; Heat: all loads stops operation.	<ol style="list-style-type: none"> 1. Temperature sensor is not connected well or damaged; 2. Temperature sensor wire of outdoor unit is damaged; short circuit between the temperature sensor and copper pipe or outer case 3. Main board of outdoor unit is damaged;

Error code	Malfunction name	AC status	Possible causes
F4	Outdoor condenser temperature sensor is open/short-circuited	Cool/Dry: compressor and outdoor fan stop operation, while indoor fan operates; Heat: after operating for 3mins, all loads stops operation.	1. Temperature sensor is not connected well or damaged; 2. Temperature sensor wire of outdoor unit is damaged; short circuit between the temperature sensor and copper pipe or outer case; 3. Main board of outdoor unit is damaged.
F5	Outdoor air discharge temperature is open/short-circuited	Complete unit stops operation; motor of sliding door is cut off power.	1. The exhaust temperature sensor is not connected well or damaged. 2. Temperature sensor wire of outdoor unit is damaged; short circuit between the temperature sensor and copper pipe or outer case 3. Main board of outdoor unit is damaged;
FC	Malfunction of micro switch	Cool/Dry: compressor stops operation, while indoor fan operates; Heat: all loads stops operation.	1. The sliding door is blocked; 2. Malfunction of the photoelectric inspection panel of sliding door;
H4	System is abnormal	Cool/Dry: all loads stops operation except indoor fan; Heat: all loads stops operation.	See "High temperature prevention protection; high power; system is abnormal"
H7	Desynchronizing of compressor	Cool/Dry: compressor stops operation, while indoor fan operates; Heat: all loads stops operation.	See "Desynchronization diagnosis for compressor"
HC	PFC protection	Cool/Dry: compressor stops operation, while indoor fan operates; Heat: all loads stops operation.	1. The power grid quality is bad; AC input voltage fluctuates sharply; 2. Power plug of air conditioner or wiring board or reactor is not connected reliably; 3. Indoor and outdoor heat exchanger is too dirty, or air inlet/outlet is blocked; 4. Main board of outdoor unit is damaged.
HE	Demagnetization protection of compressor	Cool: compressor and outdoor fan stop operation; Heat: compressor and outdoor fan stop operation at first; about 1min later, indoor fan stops operation.	1. The main board of outdoor unit is damaged; 2. Compressor is damaged;
JF	Communication malfunction between indoor unit and inspection board	Normal operation	1. Poor connection between the indoor unit and the inspection board. 2. The main board of indoor unit is damaged; 3. The inspection board is damaged;
L1	Malfunction of humidity sensor	Compressor, outdoor fan and indoor fan stop operation;	The inspection board is damaged.
L9	High power protection	Cool: compressor and outdoor fan stops operation, while indoor fan operates.	See "High temperature prevention protection; high power; system is abnormal"
Lc	Start-up failed	Cool/Dry: compressor stops, while indoor fan operates; Heat: all loads stops operation.	See "Malfunction diagnosis for failure startup"
Ld	Lost phase	Cool: compressor and outdoor fan stop operation; Heat: compressor and outdoor fan stop operation at first; about 1min later, indoor fan stops operation.	1. The main board of outdoor unit is damaged; 2. The compressor is damaged; 3. The connection wire of compressor is not connected well.
PS	Over-phase current protection of compressor	Cool/Dry: compressor stops operation, while indoor fan operates; Heat: all loads stops operation.	See "Overload protection of compressor , High discharge temperature protection of compressor"

Error code	Malfunction name	AC status	Possible causes
OE	Undefined outdoor unit error	Cool: compressor and outdoor fan stops operation, while indoor fan operates; Heat: compressor, outdoor fan and indoor fan stop operation.	<ol style="list-style-type: none"> 1. Outdoor ambient temperature exceeds the operation range of unit (eg: less than -20°C or more than 60°C for cooling; more than 30°C for heating); 2. Are wires of compressor not connected tightly? 3. Failure startup of compressor? 4. Is compressor damaged? 5. Is main board damaged?
PE	Communication malfunction between the drive board and the main board	Cool: compressor and outdoor fan stops operation; Heat: compressor and outdoor fan stop at first; about 1min later, indoor fan stops operation;	<ol style="list-style-type: none"> 1. The drive board is damaged; 2. The main board of outdoor unit is damaged; 3. The drive board and the main board is not connected well.
PF	Circuit malfunction of module temperature sensor	Cool/Dry: compressor stops operation, while indoor fan operates; Heat: all loads stops operation.	Replace outdoor control board
PE	Module overheating protection	Cool: compressor stops operation, while indoor fan operates; Heat: all loads stops operation.	<ol style="list-style-type: none"> 1. Air inlet / air outlet of outdoor unit are blocked by filth or dirt; 2. Condenser of outdoor unit is blocked by filth or dirt; 3. IPM screw of main board is not tightened; 4. Main board of outdoor unit is damaged;
PF	Malfunction of ambient temperature sensor of drive board	Cool: compressor, outdoor fan and indoor fan stop operation; Heat: compressor and outdoor fan stop operation at first; about 1min later, indoor fan stops operation.	<ol style="list-style-type: none"> 1. The ambient temperature sensor of the drive board is not connected well; 2. Malfunction of the ambient temperature sensor of drive board.
PH	DC bus voltage is too high	Cool/Dry: compressor stops operation, while indoor fan operates; Heat: all loads stops operation.	<ol style="list-style-type: none"> 1. Measure the voltage between position L and position N on the wiring board (XT). If it's higher than 265 VAC, please turn on the unit until the power voltage is decreased to the normal range; 2. If the AC input is normal, please replace the outdoor control board.
PL	DC bus voltage is too low	Cool/Dry: compressor stops operation, while indoor fan operates; Heat: all loads stops operation.	<ol style="list-style-type: none"> 1. Measure the voltage between position L and position N on the wiring board (XT). If it's lower than 150 VAC, please turn on the unit until the power voltage is increased to the normal range; 2. If the AC input is normal, please replace the outdoor control board.
PU	Charging malfunction of capacitor	Cool/Dry: compressor stops operation, while indoor fan operates; Heat: all loads stops operation.	See "Charging malfunction of capacitor"
RF	Malfunction of RF module	Cool: compressor and outdoor fan stop operation; Heat: compressor and outdoor fan stop operation at first; about 1min later, indoor fan stops operation.	<ol style="list-style-type: none"> 1. The connection wire of RF module is not connected well. 2. Malfunction of RF module;
U1	Phase current detection circuit malfunction of	Cool: compressor and outdoor fan stops operation, while indoor fan operates; Heat: compressor, outdoor fan and indoor fan stops operation.	The control board is damaged
U2	Lost phase protection of compressor	Cool: compressor and outdoor fan stop operation; Heat: compressor and outdoor fan stop operation at first; about 1min later, indoor fan stops operation.	<ol style="list-style-type: none"> 1. The main board of outdoor unit is damaged; 2. The compressor is damaged; 3. The connection wire of compressor is not connected well.

Error code	Malfunction name	AC status	Possible causes
U3	DC bus voltage drop malfunction	Cool/Dry: compressor stops operation, while indoor fan operates; Heat: all loads stops operation.	The power voltage is unstable.
U5	Current detection malfunction of unit	Cool: compressor and outdoor fan stops operation, while indoor fan operates; Heat: compressor, outdoor fan and indoor fan stops operation.	1. Is the complete unit lacking of refrigerant? 2. There's malfunction for the circuit of control board of outdoor unit. Replace the control board of outdoor unit.
U7	4-way valve is abnormal	This malfunction occurs when the unit is heating. All loads stops operation.	1. Power voltage is lower than AC175V; 2. Wiring terminal of 4-way valve is loose or broken;3. 4-way valve is damaged. Replace the 4-way valve.
U8	Malfunction of zero-crossing signal of indoor unit	Compressor, outdoor fan and indoor fan stop operation.	1. The power is abnormal; 2. Main board of indoor unit is damaged.
U9	Zero-crossing malfunction of outdoor unit	Cool: compressor stops operation, while indoor fan operates; Heat: all loads stops operation.	Replace the control board of outdoor unit.
E2	Evaporator anti-freezing protection		Not error code, it is the status code in cooling process
E9	Anti cold air protection		Not error code, it is the status code in cooling process
	Defrosting	Heat indicator Flash once/10s	Not error code, it is the status code in cooling process

Analysis or processing of some of the malfunction display:

1. Compressor discharge protection

Possible causes: shortage of refrigerant; blockage of air filter; poor ventilation or air flow short pass for condenser; the system has noncondensing gas (such as air, water etc.); blockage of capillary assy (including filter); leakage inside four-way valve causes incorrect operation; malfunction of compressor; malfunction of protection relay; malfunction of discharge sensor; outdoor temperature too high.

Processing method: refer to the malfunction analysis in the above section.

2. Low voltage overcurrent protection

Possible cause: Sudden drop of supply voltage.

3. Communication malfunction

Processing method: Check if communication signal cable is connected reliably.

4. Sensor open or short circuit

Processing method: Check whether sensor is normal, connected with the corresponding position on the controller and if damage of lead wire is found.

5. Compressor over load protection

Possible causes: insufficient or too much refrigerant; blockage of capillary and increase of suction temp.; improper running of compressor, burning in or stuck of bearing, damage of discharge valve; malfunction of protector.

Processing method: adjust refrigerant amount; replace the capillary; replace the compressor; use universal meter to check if the contactor of compressor is fine when it is not overheated, if not replace the protector.

6. System malfunction

i.e. overload protection. When tube temperature (Check the temperature of outdoor heat exchanger when cooling and check the temperature of indoor heat exchanger when heating) is too high, protection will be activated.

Possible causes: Outdoor temperature is too high when cooling; insufficient outdoor air circulation; refrigerant flow malfunction.

please refer to the malfunction analysis in the previous section for handling method.

7. IPM module protection

Processing method: Once the module malfunction happens, if it persists for a long time and can not be self-canceled, cut off the power and turn off the unit, and then re-energize the unit again after about 10 min. After repeating the procedure for several times, if the malfunction still exists, replace the module.

9.2 Procedure of Troubleshooting

1. Troubleshooting for jumper cap C5

Main check points:

- (1) jumper cap
- (2) control board of indoor unit

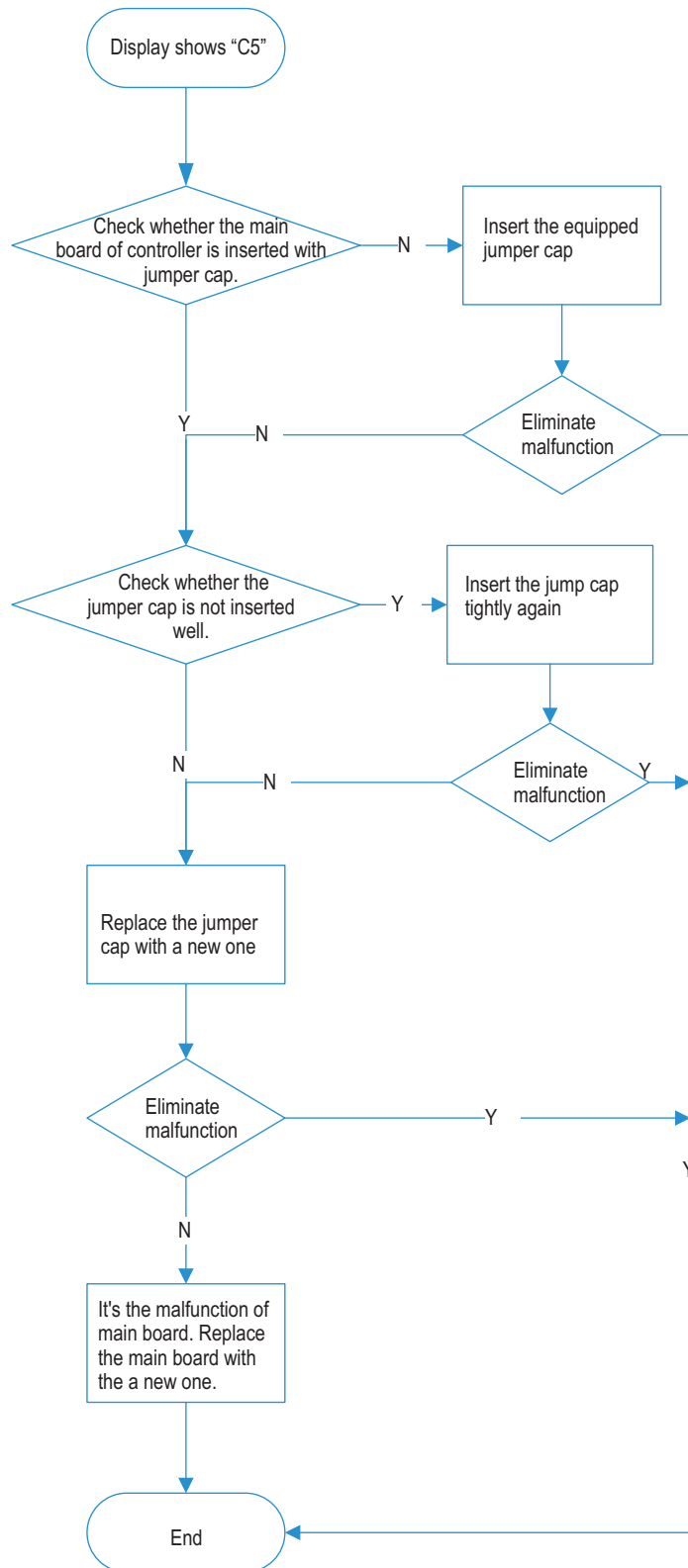

3. IPM protection H5, over-phase current of compressor P5

Main check points:

- (1) compressor COMP terminal
- (2) power supply voltage
- (3) compressor
- (4) charging amount of refrigerant
- (5) air inlet and air outlet of indoor/outdoor unit

NOTE: The control board as below means the control board of outdoor unit.

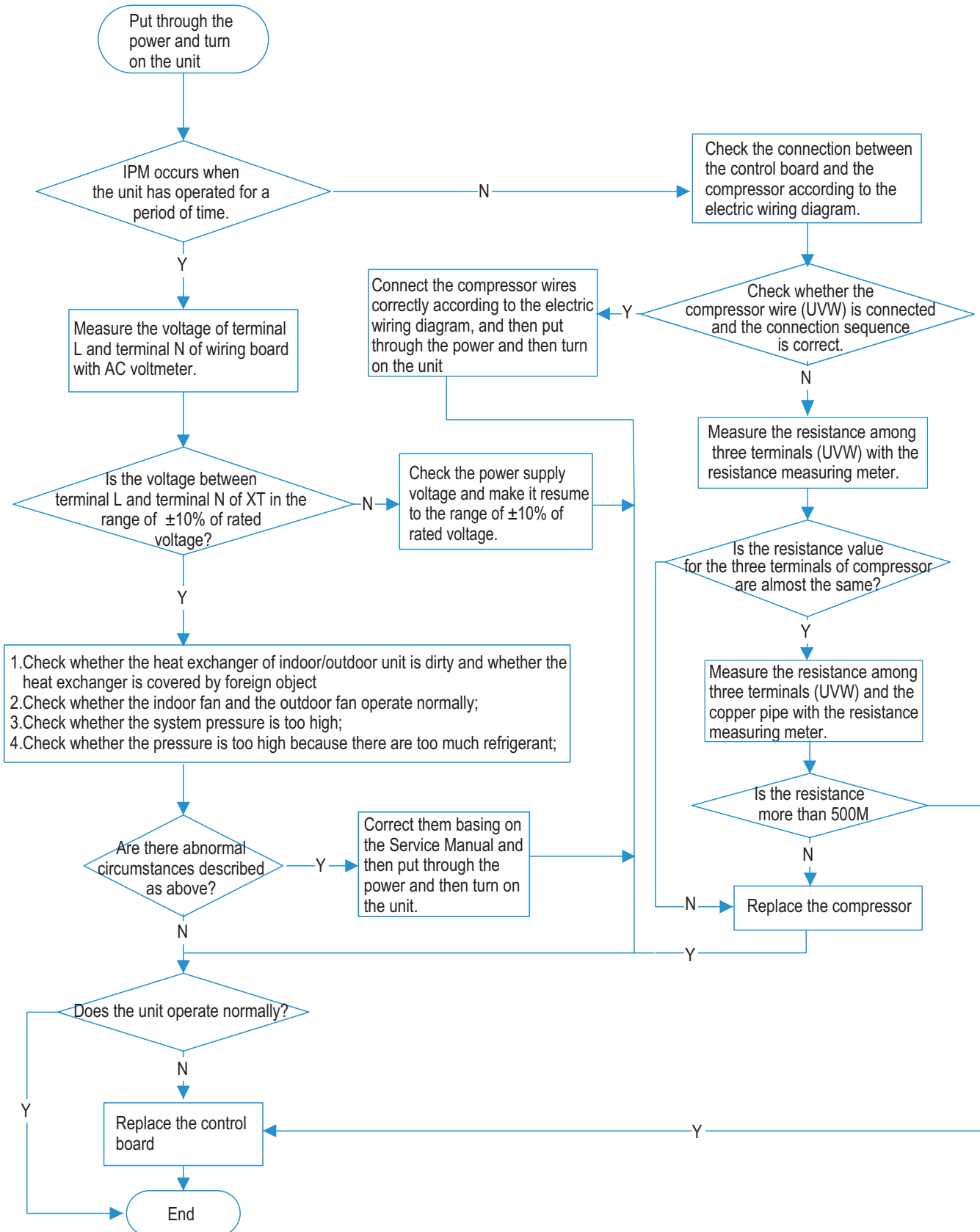

4. Overload protection of compressor H3, high discharge temperature, protection of compressor E4

Main check points:

- (1) electronic expansion valve
- (2) expansion valve terminal
- (3) charging amount of refrigerant
- (4) overload protector

NOTE: The control board as below means the control board of outdoor unit.

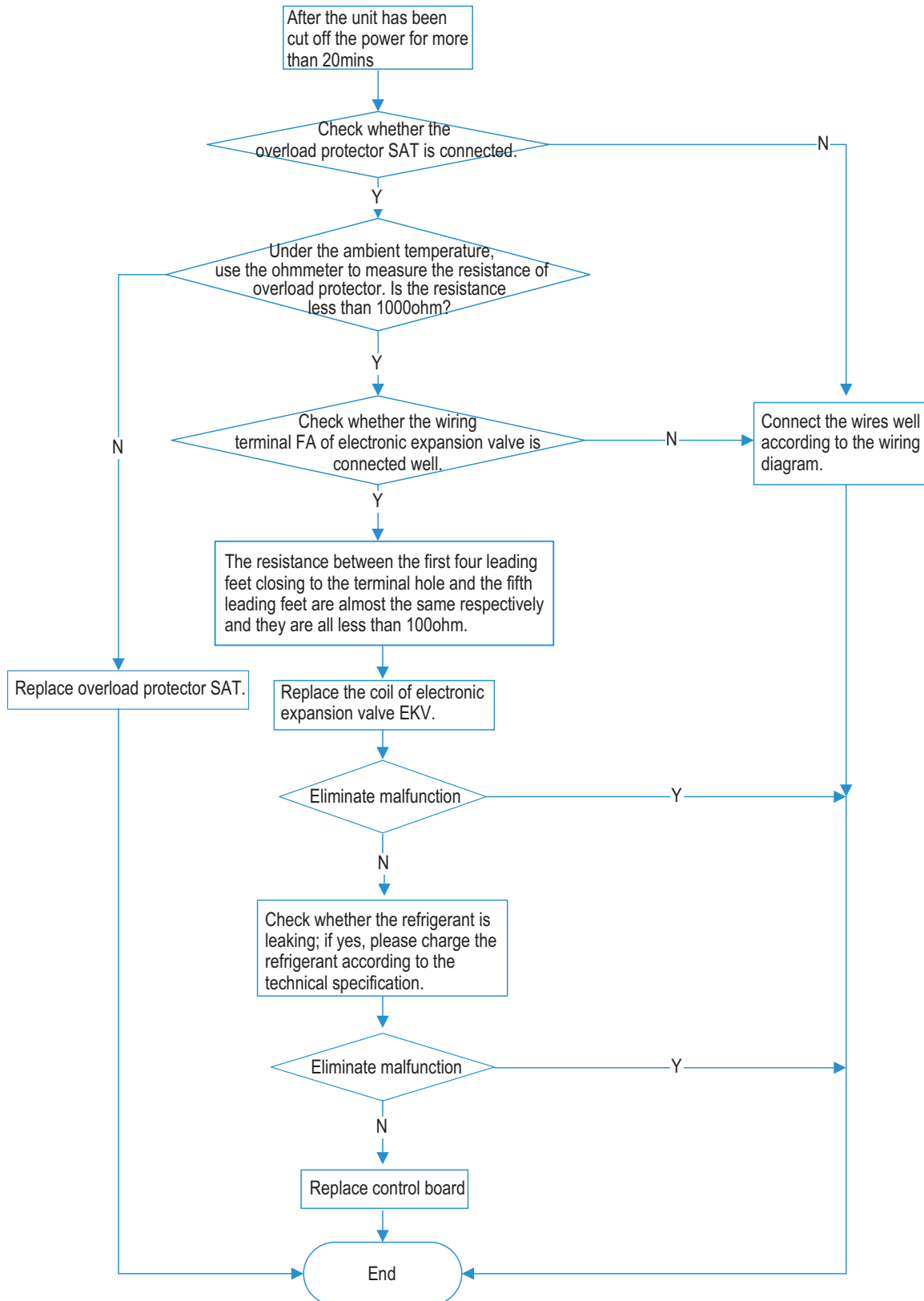

5. Troubleshooting for temperature sensor F1, F2, F3, F4, F5

Main check points:

(1) connection terminal (2) temperature sensor (3) main board

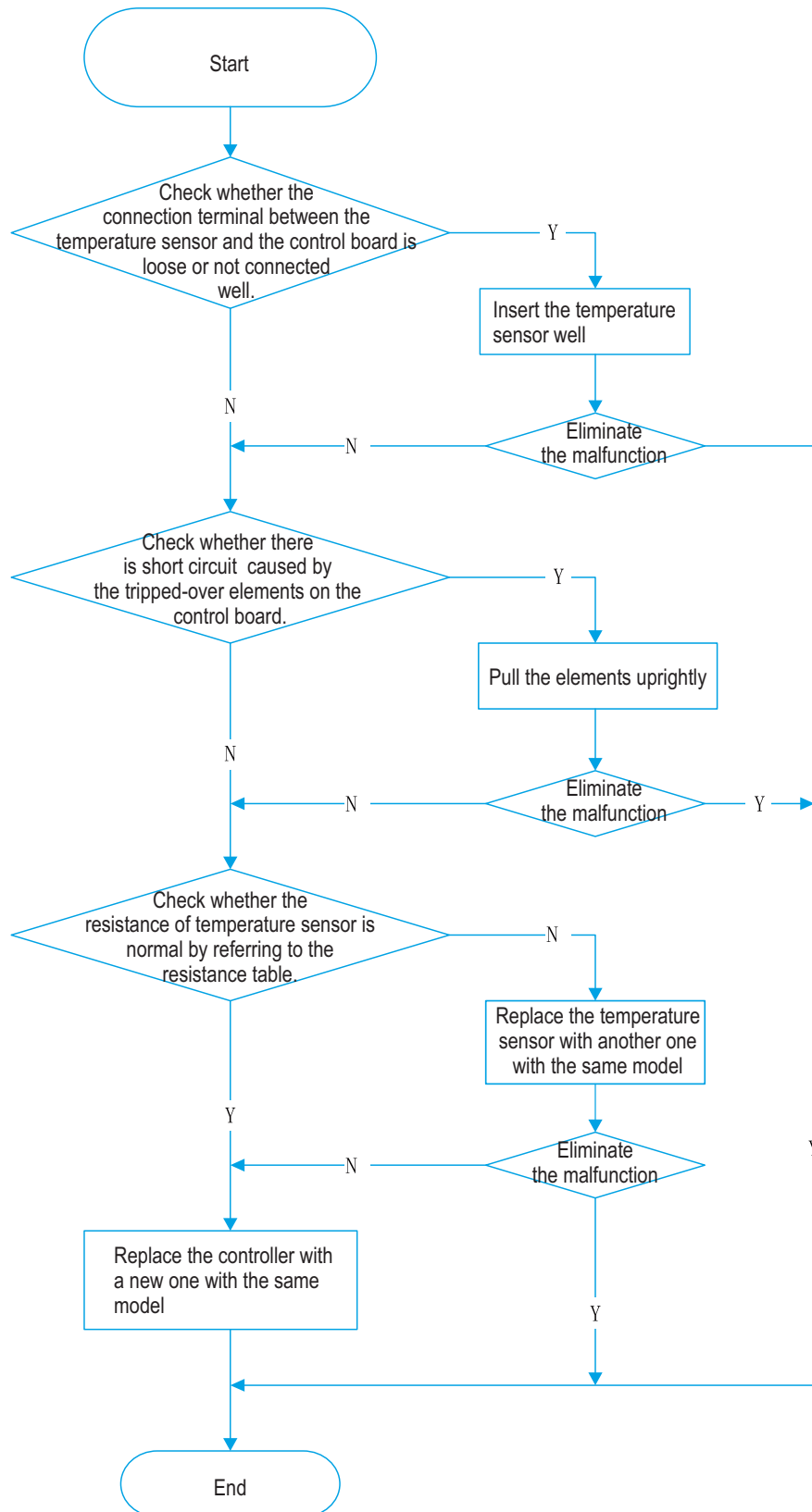

6.High temperature prevention protection E8; high power L9; system is abnormal H4

Main check points:

(1) outdoor temperature (2) fan (3)air inlet and air outlet of indoor/outdoor unit

NOTE:The control board as below means the control board of outdoor unit.

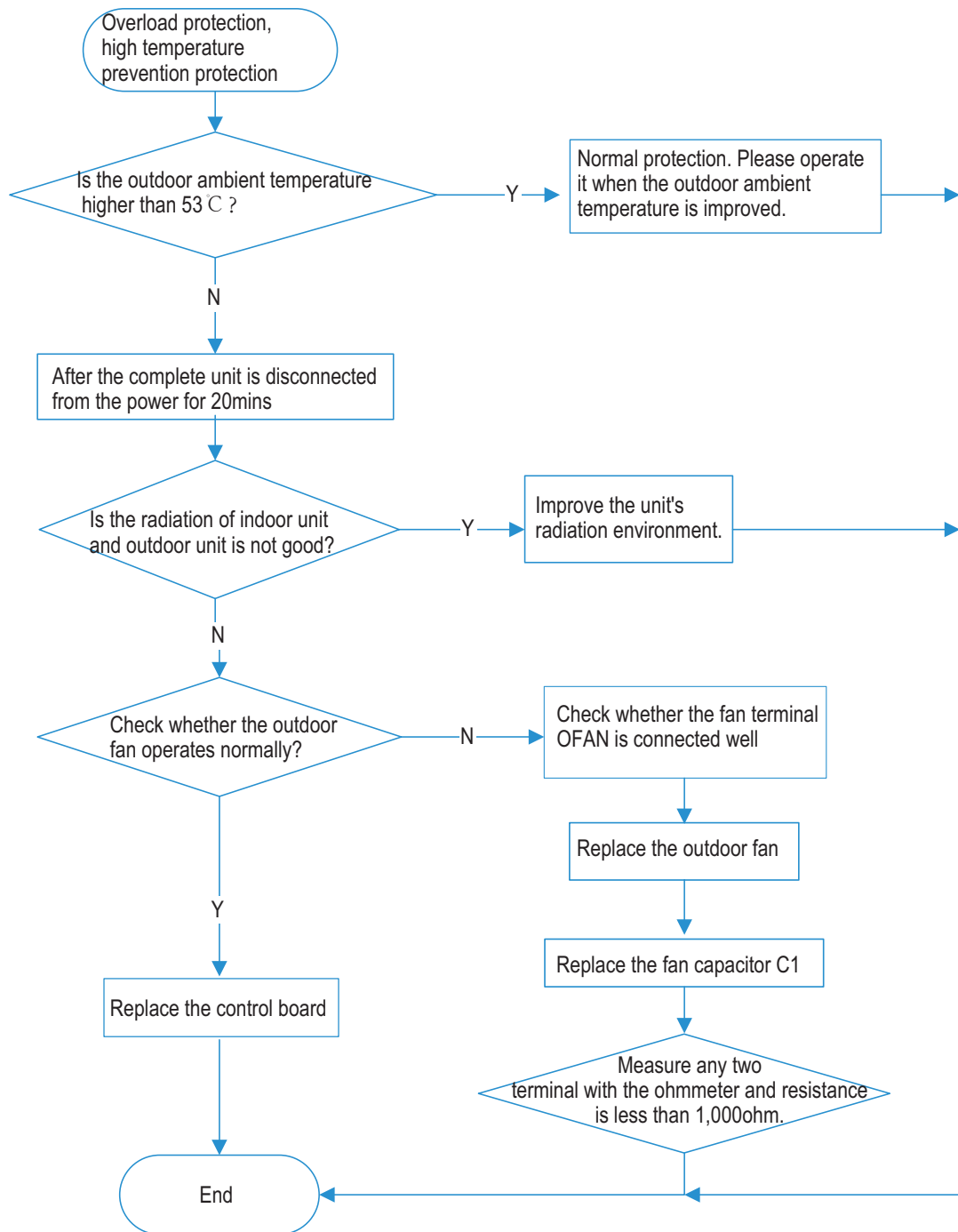

7.Desynchronization diagnosis for compressor H7

Main check point:

(1) system pressure (2) power supply voltage

NOTE:The control board as below means the control board of outdoor unit.

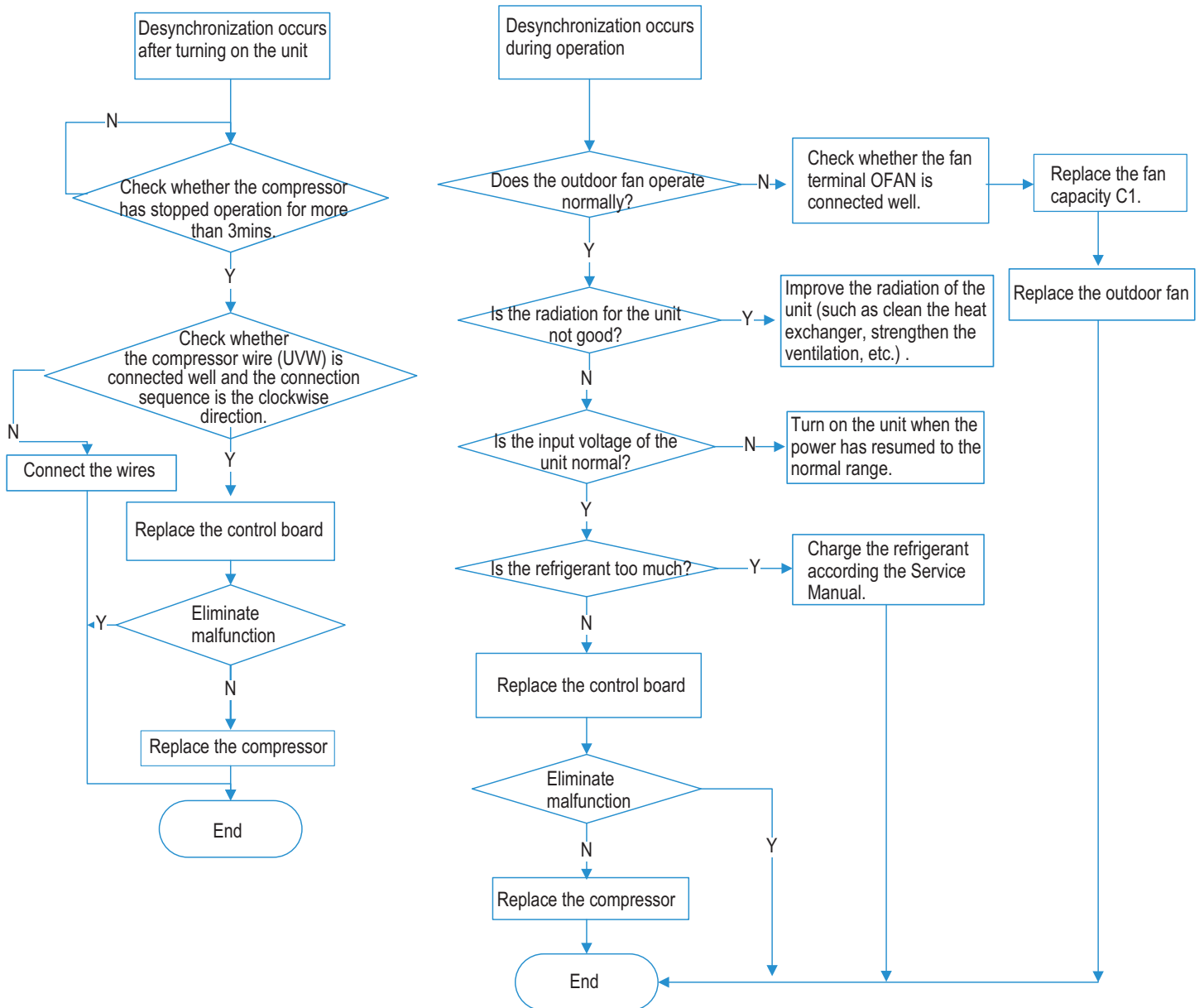

8. Malfunction diagnosis for failure startup

Main check points:

(1) compressor wire (2) compressor (3) charging amount of refrigerant

NOTE: The control board as below means the control board of outdoor unit.

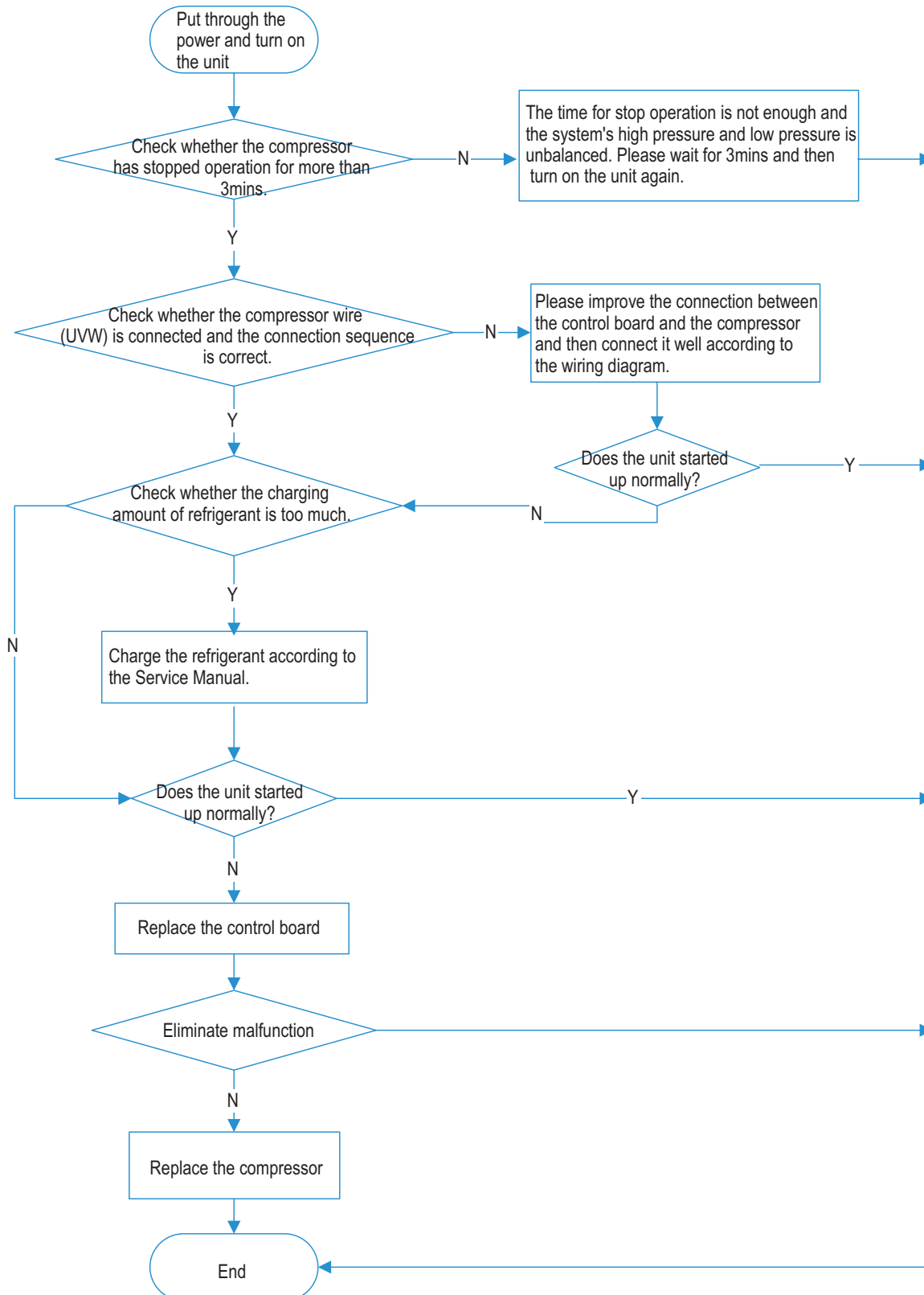

9. Charging malfunction of capacitor PU

Main check points:

(1) wiring board XT (2) reactor

NOTE: The control board as below means the control board of outdoor unit.

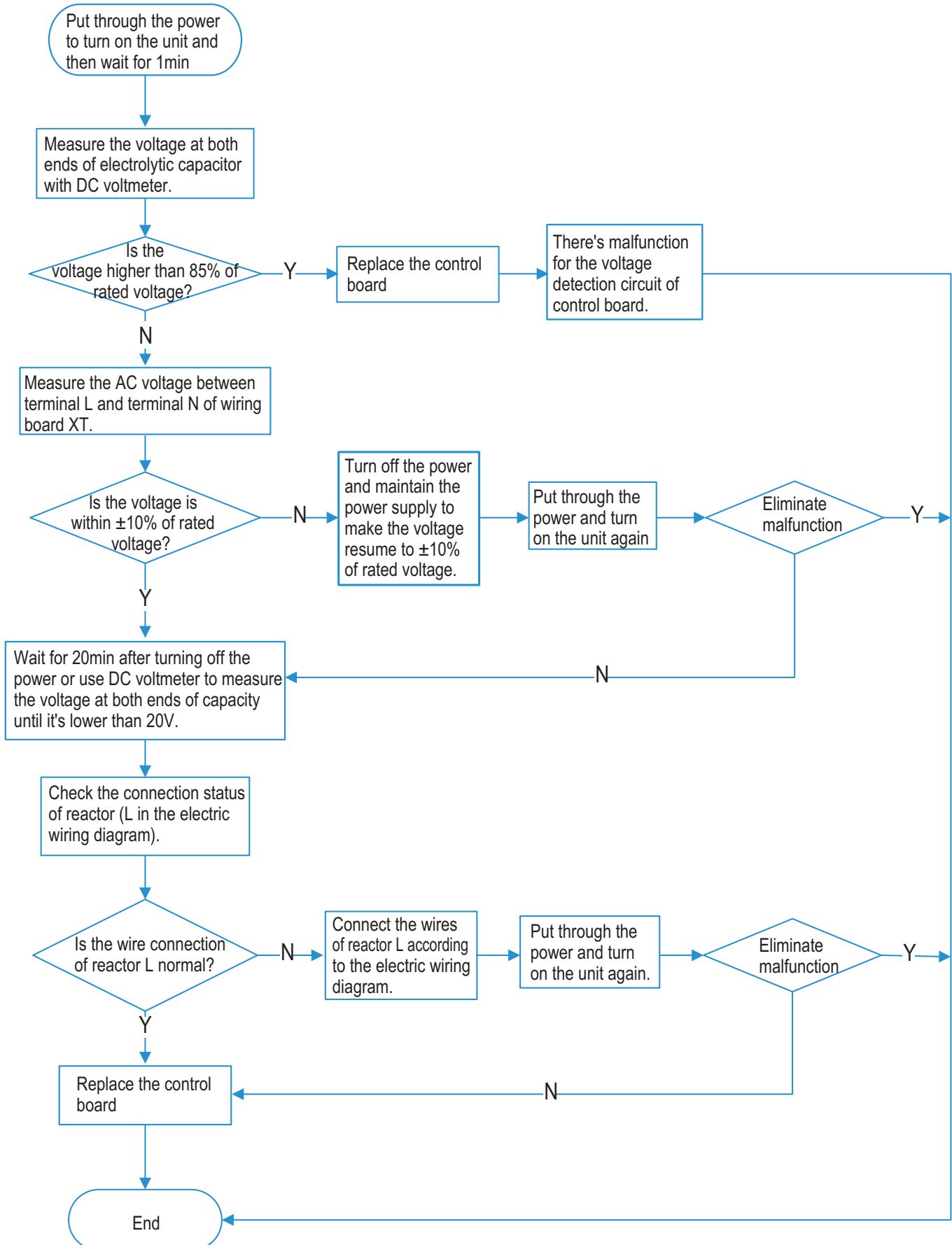

10. Troubleshooting-motor(indoor fan) doesn't operate H6

Main check points:

(1) connection terminal (2) motor (3) control board AP1 of indoor unit (4) blade

10.1 DC motor

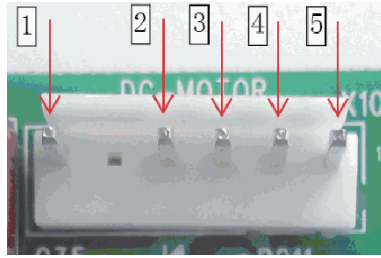
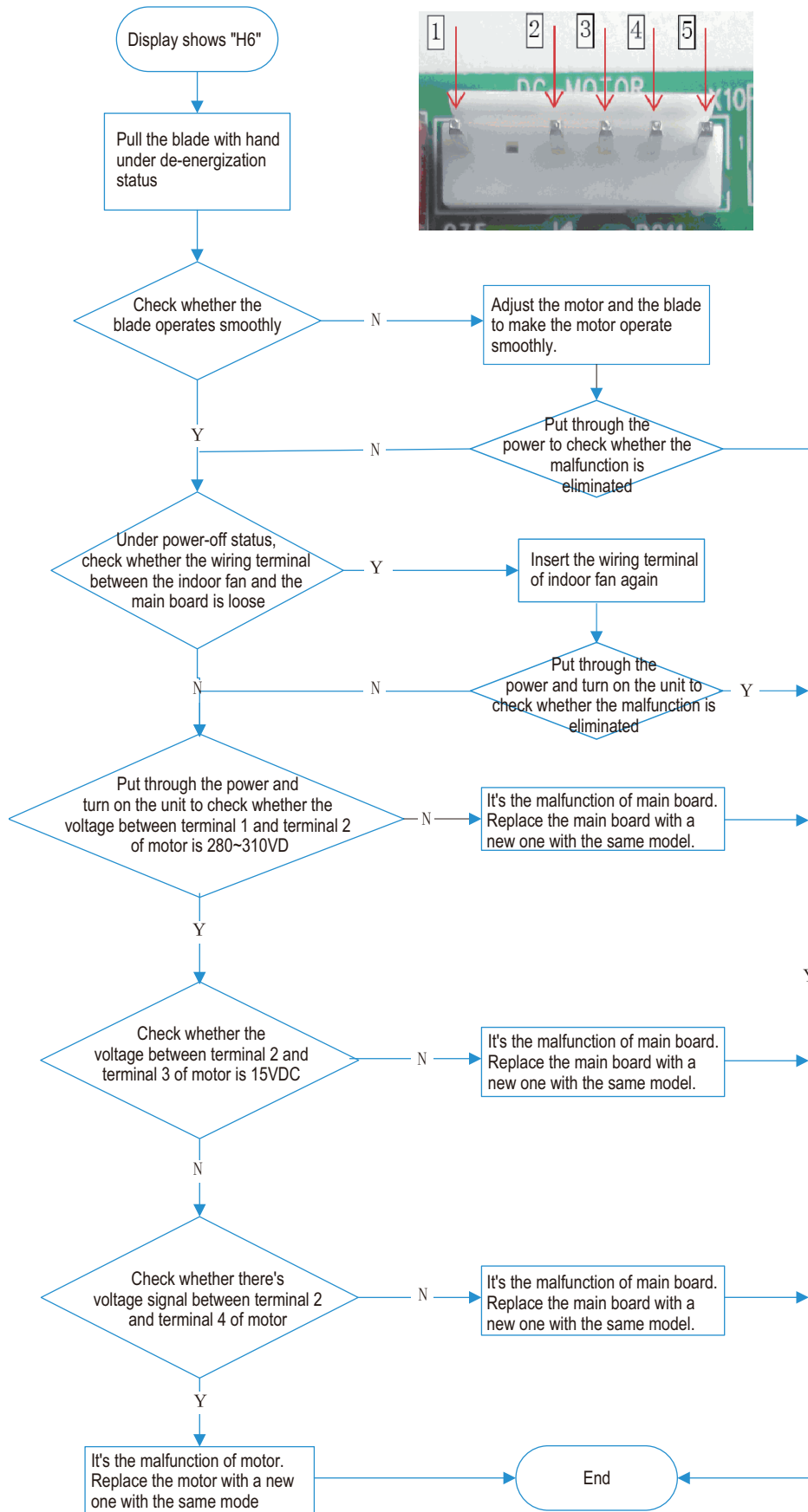

10.2 PG motor

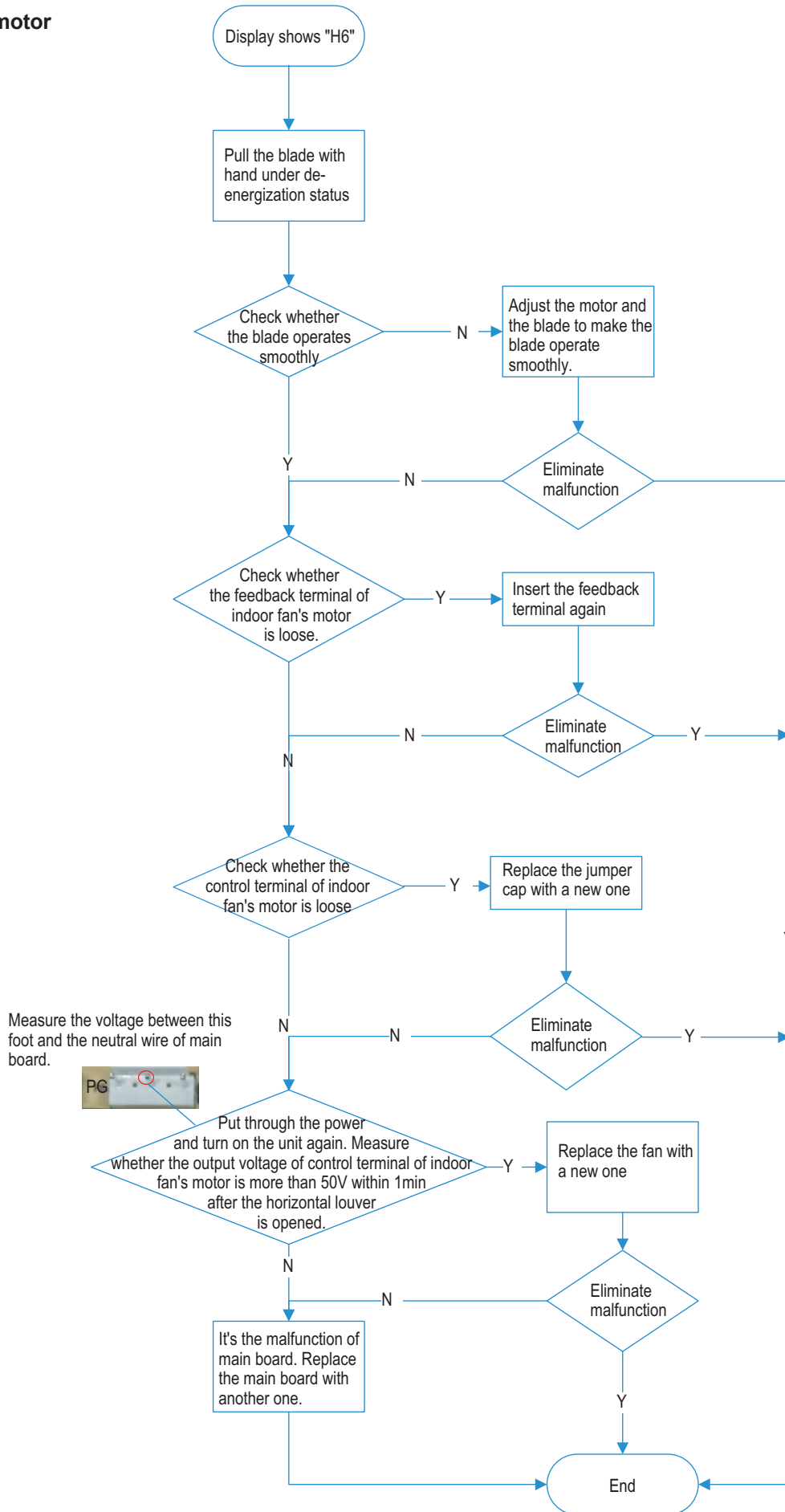

11. AC overcurrent protection E5

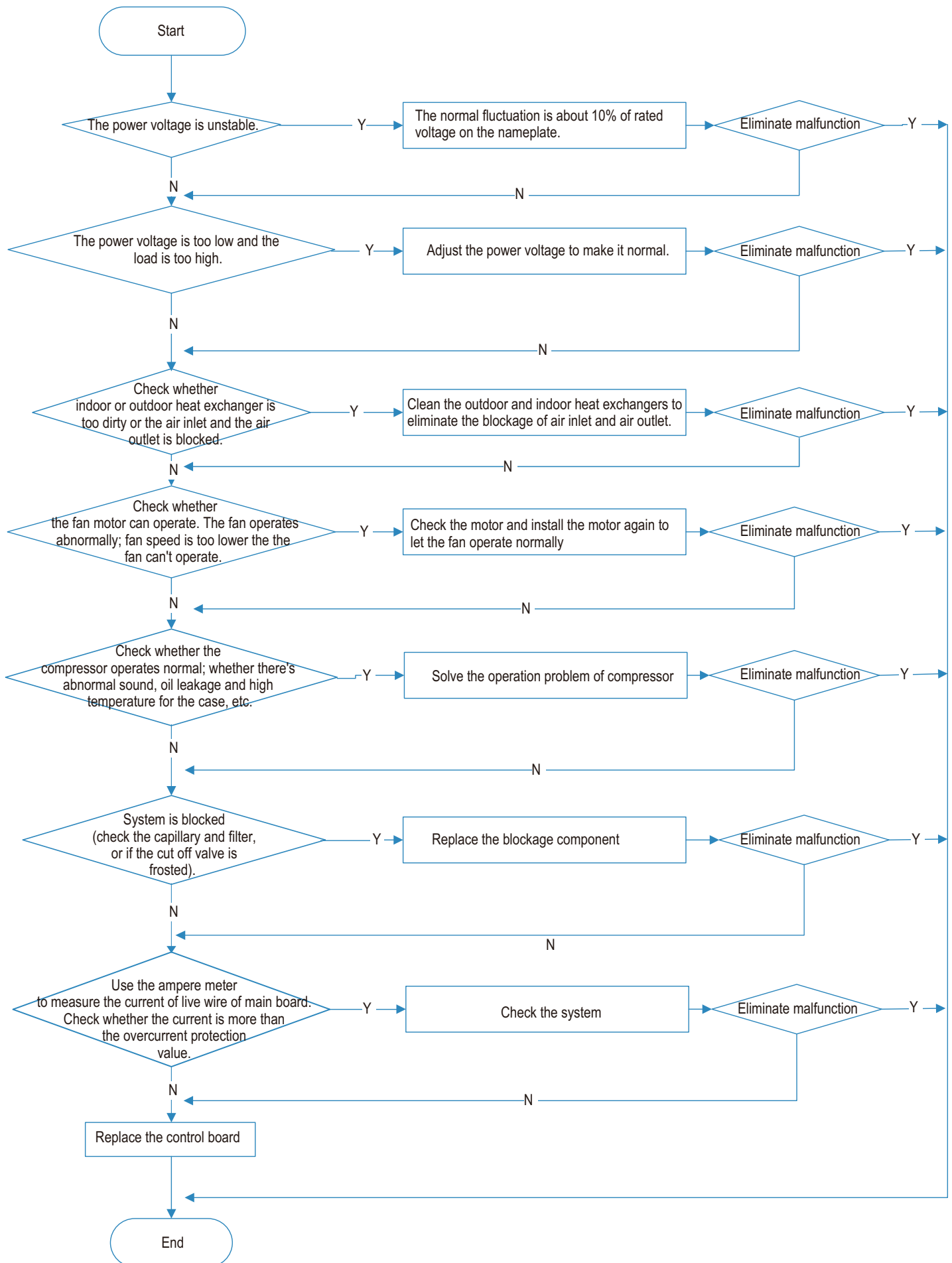

9.4 Troubleshooting for Normal Malfunction

1. Air Conditioner can't be Started Up

Possible Causes	Discriminating Method (Air conditioner Status)	Troubleshooting
No power supply, or poor connection for power plug	After energization, operation indicator isn't bright and the buzzer can't give out sound	Confirm whether it's due to power failure. If yes, wait for power recovery. If not, check power supply circuit and make sure the power plug is connected well.
Wrong wire connection between indoor unit and outdoor unit, or poor connection for wiring terminals	Under normal power supply circumstances, operation indicator isn't bright after energization	Check the circuit according to circuit diagram and connect wires correctly. Make sure all wiring terminals are connected firmly
Electric leakage for air conditioner	After energization, room circuit breaker trips off at once	Make sure the air conditioner is grounded reliably Make sure wires of air conditioner is connected correctly Check the wiring inside air conditioner. Check whether the insulation layer of power cord is damaged; if yes, place the power cord.
Model selection for air switch is improper	After energization, air switch trips off	Select proper air switch
Malfunction of remote controller	After energization, operation indicator is bright, while no display on remote controller or buttons have no action.	Replace batteries for remote controller Repair or replace remote controller

2. Poor Cooling (Heating) for Air Conditioner

Possible Causes	Discriminating Method (Air conditioner Status)	Troubleshooting
Set temperature is improper	Observe the set temperature on remote controller	Adjust the set temperature
Rotation speed of the IDU fan motor is set too low	Small wind blow	Set the fan speed at high or medium
Filter of indoor unit is blocked	Check the filter to see its blocked	Clean the filter
Installation position for indoor unit and outdoor unit is improper	Check whether the installation position is proper according to installation requirement for air conditioner	Adjust the installation position, and install the rainproof and sunproof for outdoor unit
Refrigerant is leaking	Discharged air temperature during cooling is higher than normal discharged wind temperature; Discharged air temperature during heating is lower than normal discharged wind temperature; Units pressure is much lower than regulated range	Find out the leakage causes and deal with it. Add refrigerant.
Malfunction of 4-way valve	Blow cold wind during heating	Replace the 4-way valve
Malfunction of capillary	Discharged air temperature during cooling is higher than normal discharged wind temperature; Discharged air temperature during heating is lower than normal discharged wind temperature; Unit pressure is much lower than regulated range. If refrigerant isn't leaking, part of capillary is blocked	Replace the capillary
Flow volume of valve is insufficient	The pressure of valves is much lower than that stated in the specification	Open the valve completely
Malfunction of horizontal louver	Horizontal louver can't swing	Refer to point 3 of maintenance method for details
Malfunction of the IDU fan motor	The IDU fan motor can't operate	Refer to troubleshooting for H6 for maintenance method in details
Malfunction of the ODU fan motor	The ODU fan motor can't operate	Refer to point 4 of maintenance method for details
Malfunction of compressor	Compressor can't operate	Refer to point 5 of maintenance method for details

3. Horizontal Louver can't Swing

Possible Causes	Discriminating Method (Air conditioner Status)	Troubleshooting
Wrong wire connection, or poor connection	Check the wiring status according to circuit diagram	Connect wires according to wiring diagram to make sure all wiring terminals are connected firmly
Stepping motor is damaged	Stepping motor can't operate	Repair or replace stepping motor
Main board is damaged	Others are all normal, while horizontal louver can't operate	Replace the main board with the same model

4. ODU Fan Motor can't Operate

Possible causes	Discriminating method (air conditioner status)	Troubleshooting
Wrong wire connection, or poor connection	Check the wiring status according to circuit diagram	Connect wires according to wiring diagram to make sure all wiring terminals are connected firmly
Capacity of the ODU fan motor is damaged	Measure the capacity of fan capacitor with an universal meter and find that the capacity is out of the deviation range indicated on the nameplate of fan capacitor.	Replace the capacity of fan
Power voltage is a little low or high	Use universal meter to measure the power supply voltage. The voltage is a little high or low	Suggest to equip with voltage regulator
Motor of outdoor unit is damaged	When unit is on, cooling/heating performance is bad and ODU compressor generates a lot of noise and heat.	Change compressor oil and refrigerant. If no better, replace the compressor with a new one

5. Compressor can't Operate

Possible causes	Discriminating method (air conditioner status)	Troubleshooting
Wrong wire connection, or poor connection	Check the wiring status according to circuit diagram	Connect wires according to wiring diagram to make sure all wiring terminals are connected firmly
Capacity of compressor is damaged	Measure the capacity of fan capacitor with an universal meter and find that the capacity is out of the deviation range indicated on the nameplate of fan capacitor.	Replace the compressor capacitor
Power voltage is a little low or high	Use universal meter to measure the power supply voltage. The voltage is a little high or low	Suggest to equip with voltage regulator
Coil of compressor is burnt out	Use universal meter to measure the resistance between compressor terminals and it's 0	Repair or replace compressor
Cylinder of compressor is blocked	Compressor can't operate	Repair or replace compressor

6. Air Conditioner is Leaking

Possible causes	Discriminating method (air conditioner status)	Troubleshooting
Drain pipe is blocked	Water leaking from indoor unit	Eliminate the foreign objects inside the drain pipe
Drain pipe is broken	Water leaking from drain pipe	Replace drain pipe
Wrapping is not tight	Water leaking from the pipe connection place of indoor unit	Wrap it again and bundle it tightly

7. Abnormal Sound and Vibration

Possible causes	Discriminating method (air conditioner status)	Troubleshooting
When turn on or turn off the unit, the panel and other parts will expand and theres abnormal sound	Theres the sound of "PAPA"	Normal phenomenon. Abnormal sound will disappear after a few minutes.
When turn on or turn off the unit, theres abnormal sound due to flow of refrigerant inside air conditioner	Water-running sound can be heard	Normal phenomenon. Abnormal sound will disappear after a few minutes.
Foreign objects inside the indoor unit or therere parts touching together inside the indoor unit	Theres abnormal sound fro indoor unit	Remove foreign objects. Adjust all parts position of indoor unit, tighten screws and stick damping plaster between connected parts
Foreign objects inside the outdoor unit or therere parts touching together inside the outdoor unit	Theres abnormal sound fro outdoor unit	Remove foreign objects. Adjust all parts position of outdoor unit, tighten screws and stick damping plaster between connected parts
Short circuit inside the magnetic coil	During heating, the way valve has abnormal electromagnetic sound	Replace magnetic coil
Abnormal shake of compressor	Outdoor unit gives out abnormal sound	Adjust the support foot mat of compressor, tighten the bolts
Abnormal sound inside the compressor	Abnormal sound inside the compressor	If add too much refrigerant during maintenance, please reduce refrigerant properly. Replace compressor for other circumstances.



10. Removal Procedure

10.1 Removal Procedure of Indoor Unit

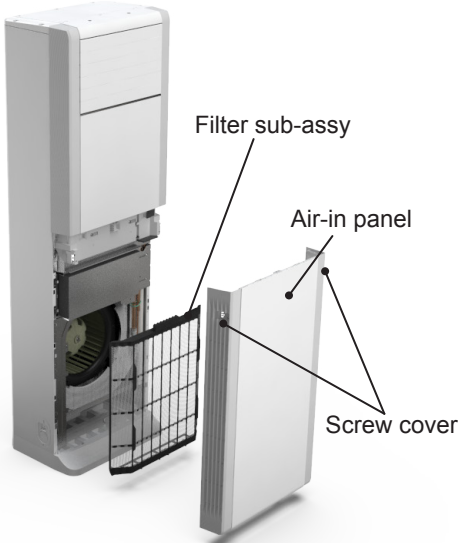
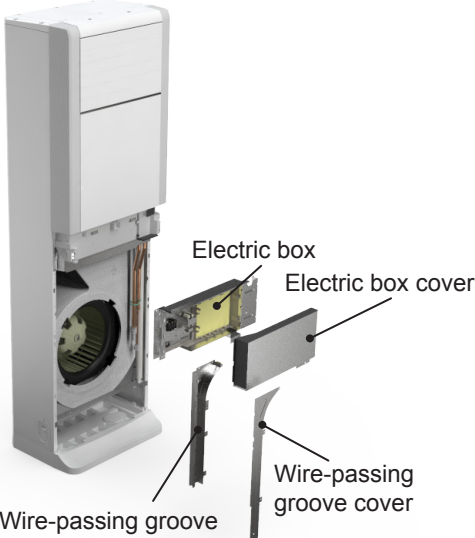

Caution: discharge the refrigerant completely before removal.

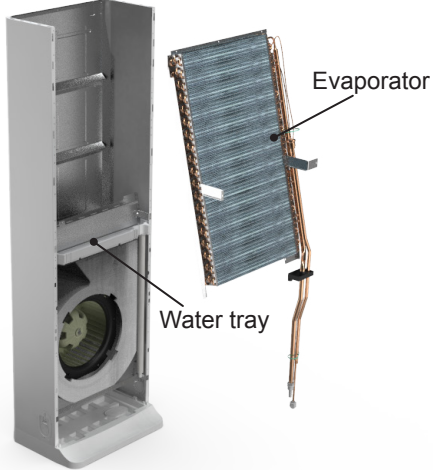
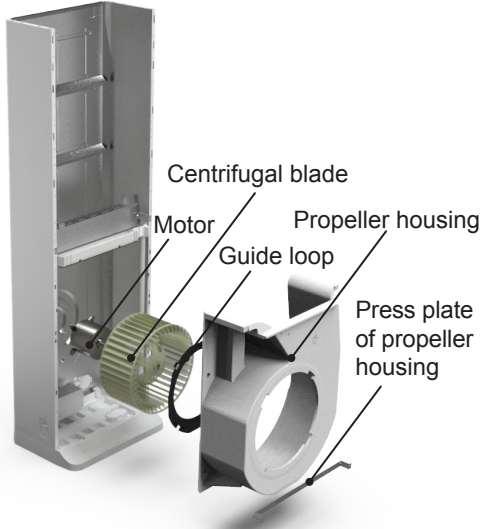
Step	Procedure
1. Before disassemble	
2. Remove filter sub-assy	<p>(1) Open the screw cover, use the screwdriver to remove 2 screws at both sides of air-in panel and then pull the air-in panel to remove it; (2) Draw out the filter sub-assy.</p> 
3. Remove electric box and wire-passing groove sub-assy	<p>Remove 4 screws used for fixing the electric box cover, remove the electric box cover and then pull out the wiring terminals for each component. At this time, you can remove related electric components according to the needs; Remove 9 screws used for fixing the electric box, pull the electric box outwards to remove it. Remove 3 screws used for fixing the wirepassing groove, and then remove the wirepassing groove cover. Remove 3 screws used for fixing the wirepassing groove and then remove the wirepassing groove sub-assy.</p> 



Step	Procedure
<p>7. Remove evaporator</p>	<p>Remove 3 screws on the evaporator, 2 screw at the middle part and 2 screws at the lower part. Pull left and right side plates outwards slightly and then take out the evaporator, baffle board and water tray.</p> <p>When the evaporator is removed, the left and the right air damper and the baffle board of the evaporator can be removed.</p> 
<p>8. Remove retaining plate of water tray and evaporator</p>	<p>Remove 3 screws used for fixing the press plate of propeller housing and then remove the press plate of propeller housing;</p> <p>Rotate the guide loop to a certain position along the clockwise direction, and then remove the guide loop;</p> <p>Remove 9 screws used for fixing the propeller housing, and then remove the propeller housing;</p> <p>Use wrench to twist off the nuts used for fixing the centrifugal chiller and then pull the centrifugal blade outwards;</p> <p>Remove the centrifugal blade;</p> <p>Remove 4 nuts used for fixing the motor and 2 screws used for fixing the wire-pressing plate, and then remove the motor.</p> 
<p>9. Remove breakwater sub-assy and water tray sub-assy</p>	<p>Remove 2 screws used for fixing the left and right side plate and then remove the breakwater sub-assy and water tray sub-assy.</p> 

10.2 Removal Procedure of Outdoor Unit

XH :Take the heat pump for example

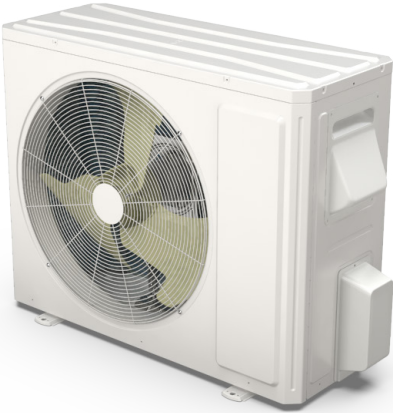
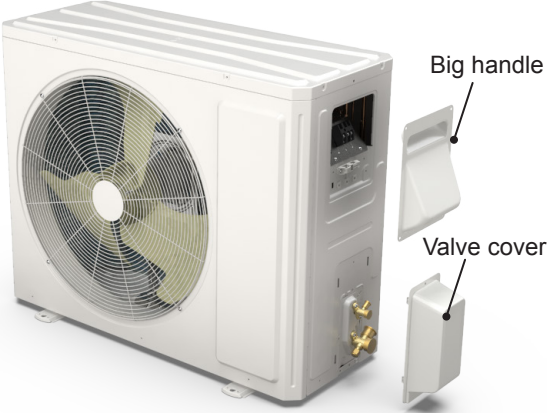

Warning: Before disassembly, please disconnect the power supply. Before disconnection the pipeline, please discharge all the refrigerant according to the local laws and regulations.

Step	Procedure
1. Before disassembly	
2. Remove big handle and valve cover	<p data-bbox="191 1181 781 1247">Remove the screws fixing big handle, valve cover and then remove them.</p> 
3. Remove top cover	<p data-bbox="191 1771 781 1836">Remove the screws fixing top panel and then remove the top panel.</p> 

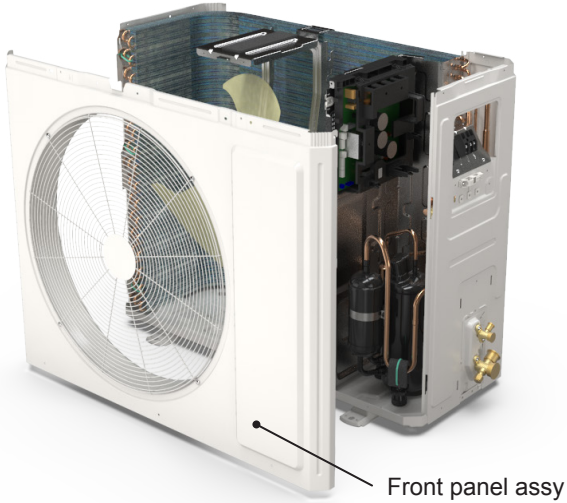
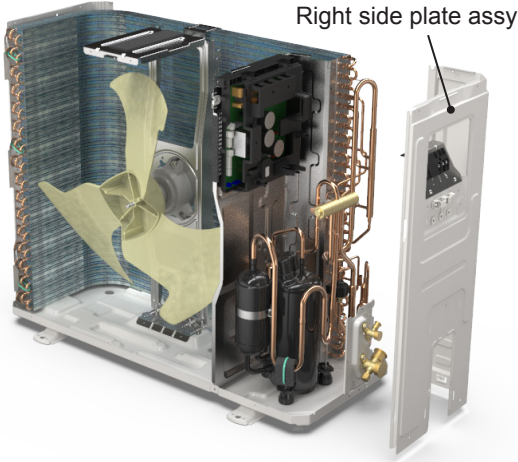
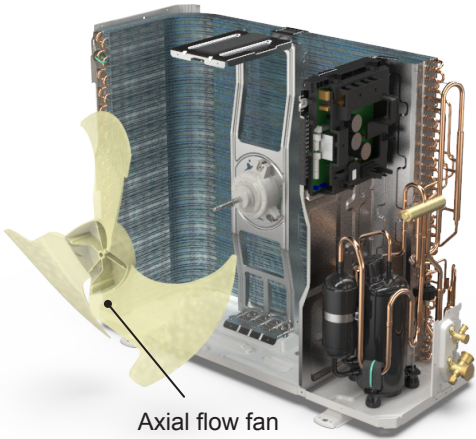
Step	Procedure
<p>4. Remove front panel assy</p>	<p>Remove connection screws connecting the front panel assy with the chassis and the motor support, and then remove the front panel assy.</p> 
<p>5. Remove right side plate assy</p>	<p>Rescrew the ground screws, remove the ground wires, loosen the screws fixing terminal board, remove the terminal board, rescrew the screws fixing the right plate, and remove the right side plate assy.</p> 
<p>6. Remove axial flow fan</p>	<p>Remove the nut on the fan and then remove the axial flow fan.</p> 

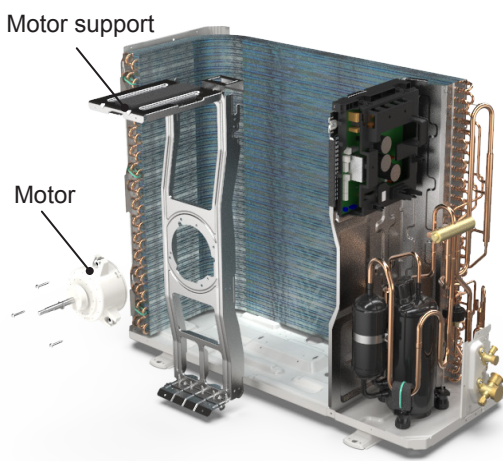
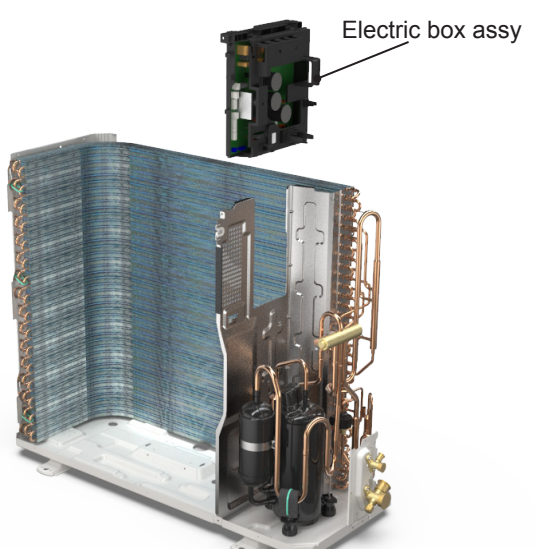
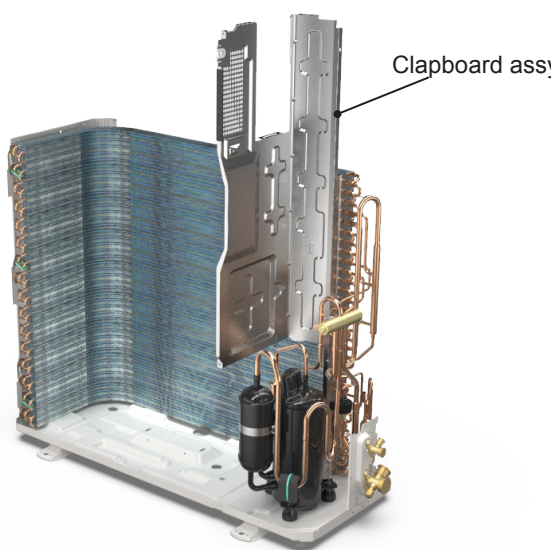
Step	Procedure
<p>7. Remove motor support and motor</p>	<p>Remove the screws fixing the motor support and lift the motor support to remove it. Remove the screws fixing the motor and then remove the motor.</p> 
<p>8. Remove electric box assy</p>	<p>Remove the terminals, lift up and rotate the electrical box assy to the right so that the snaps on the clapboard are removed and the electrical box assy are removed.</p> 
<p>9. Remove clapboard assy</p>	<p>Remove the screws fixing the clapboard assy and then remove the clapboard assy.</p> 

Appendix:

Appendix 1: Reference Sheet of Celsius and Fahrenheit

Conversion formula for Fahrenheit degree and Celsius degree: $T_f = T_c \times 1.8 + 32$

Set temperature

Fahrenheit display temperature (°F)	Fahrenheit (°F)	Celsius (°C)	Fahrenheit display temperature (°F)	Fahrenheit (°F)	Celsius (°C)	Fahrenheit display temperature (°F)	Fahrenheit (°F)	Celsius (°C)
61	60.8	16	69/70	69.8	21	78/79	78.8	26
62/63	62.6	17	71/72	71.6	22	80/81	80.6	27
64/65	64.4	18	73/74	73.4	23	82/83	82.4	28
66/67	66.2	19	75/76	75.2	24	84/85	84.2	29
68	68	20	77	77	25	86	86	30

Ambient temperature

Fahrenheit display temperature (°F)	Fahrenheit (°F)	Celsius (°C)	Fahrenheit display temperature (°F)	Fahrenheit (°F)	Celsius (°C)	Fahrenheit display temperature (°F)	Fahrenheit (°F)	Celsius (°C)
32/33	32	0	55/56	55.4	13	79/80	78.8	26
34/35	33.8	1	57/58	57.2	14	81	80.6	27
36	35.6	2	59/60	59	15	82/83	82.4	28
37/38	37.4	3	61/62	60.8	16	84/85	84.2	29
39/40	39.2	4	63	62.6	17	86/87	86	30
41/42	41	5	64/65	64.4	18	88/89	87.8	31
43/44	42.8	6	66/67	66.2	19	90	89.6	32
45	44.6	7	68/69	68	20	91/92	91.4	33
46/47	46.4	8	70/71	69.8	21	93/94	93.2	34
48/49	48.2	9	72	71.6	22	95/96	95	35
50/51	50	10	73/74	73.4	23	97/98	96.8	36
52/53	51.8	11	75/76	75.2	24	99	98.6	37
54	53.6	12	77/78	77	25			

Appendix 2: Configuration of Connection Pipe

- Standard length of connection pipe (More details please refer to the specifications.)
- Min. length of connection pipe for the unit with standard connection pipe of 5m, there is no limitation for the min. length of connection pipe. For the unit with standard connection pipe of 7.5m and 8m, the min. length of connection pipe is 3m.
- Max. length of connection pipe and max. high difference. (More details please refer to the specifications.)
- The additional refrigerant oil and refrigerant charging required after prolonging connection pipe
 - After the length of connection pipe is prolonged for 10m at the basis of standard length, you should add 5ml of refrigerant oil for each additional 5m of connection pipe.
 - The calculation method of additional refrigerant charging amount (on the basis of liquid pipe):
 - Basing on the length of standard pipe, add refrigerant according to the requirement as shown in the table. The additional refrigerant charging amount per meter is different according to the diameter of liquid pipe. See the following sheet.
 - Additional refrigerant charging amount = prolonged length of liquid pipe X additional refrigerant charging amount per meter.

Additional refrigerant charging amount for R32			
Liquid pipe	Gas pipe	Cooling only(g/m)	Cooling and heating(g/m)
1/4"	3/8" or 1/2"	12	16
1/4" or 3/8"	5/8" or 3/4"	12	40
1/2"	3/4" or 7/8"	24	96
5/8"	1" or 1 1/4"	48	96
3/4"	/	200	200
7/8"	/	280	280

Appendix 3: Pipe Expanding Method

⚠ Note:

Improper pipe expanding is the main cause of refrigerant leakage. Please expand the pipe according to the following steps:

A: Cut the pipe

- Confirm the pipe length according to the distance of indoor unit and outdoor unit.
- Cut the required pipe with pipe cutter.

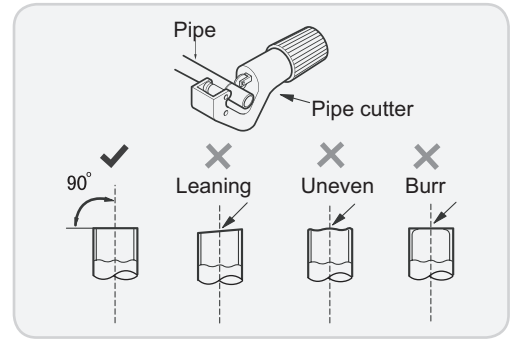

B: Remove the burrs

- Remove the burrs with shaper and prevent the burrs from getting into the pipe.

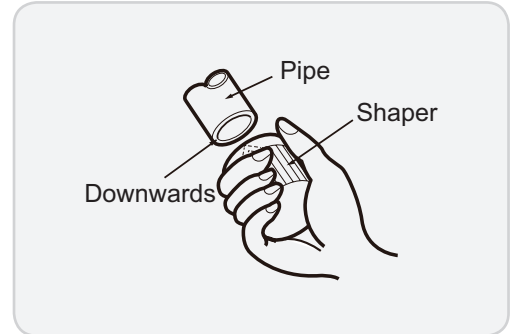

C: Put on suitable insulating pipe.

D: Put on the union nut

- Remove the union nut on the indoor connection pipe and outdoor valve; install the union nut on the pipe.

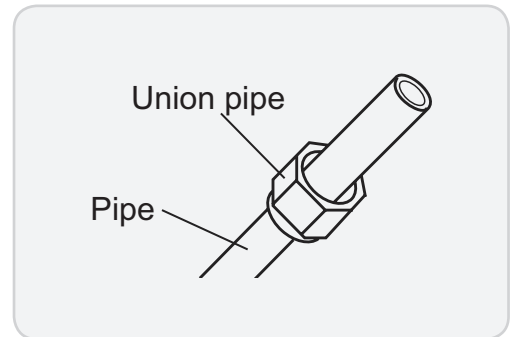

E: Expand the port

- Expand the port with expander.

⚠ Note:

- "A" is different according to the diameter, please refer to the sheet below:

Outer diameter(mm)	A(mm)	
	Max	Min
Φ6 - 6.35 (1/4")	1.3	0.7
Φ9.52 (3/8")	1.6	1.0
Φ12 - 12.70 (1/2")	1.8	1.0
Φ16 - 15.88 (5/8")	2.4	2.2

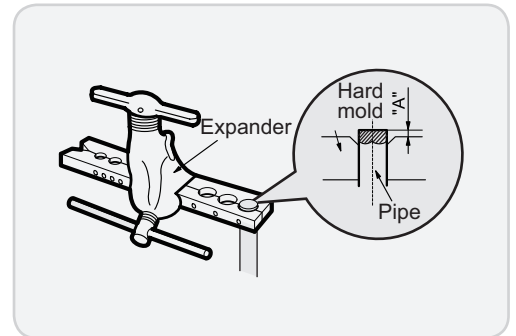

F: Inspection

- Check the quality of expanding port. If there is any blemish, expand the port again according to the steps above.

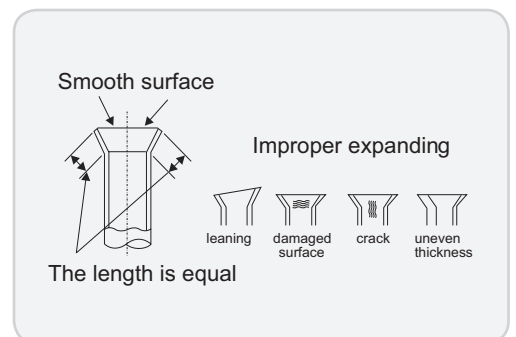

Appendix 4: List of Resistance for Temperature Sensor

Resistance Table of Ambient Temperature Sensor for Indoor and Outdoor Units (15K)

Temp(°C)	Resistance(kΩ)
-19	138.10
-18	128.60
-16	115.00
-14	102.90
-12	92.22
-10	82.75
-8	74.35
-6	66.88
-4	60.23
-2	54.31

Temp(°C)	Resistance(kΩ)
0	49.02
2	44.31
4	40.09
6	36.32
8	32.94
10	29.90
12	27.18
14	24.73
16	22.53
18	20.54

Temp(°C)	Resistance(kΩ)
20	18.75
22	17.14
24	15.68
26	14.36
28	13.16
30	12.07
32	11.09
34	10.20
36	9.38
38	8.64

Temp(°C)	Resistance(kΩ)
40	7.97
42	7.35
44	6.79
46	6.28
48	5.81
50	5.38
52	4.99
54	4.63
56	4.29
58	3.99

Resistance Table of Tube Temperature Sensors for Indoor and Outdoor (20K)

Temp(°C)	Resistance(kΩ)
-19	181.40
-15	145.00
-10	110.30
-5	84.61
0	65.37
5	50.87
10	39.87
15	31.47

Temp(°C)	Resistance(kΩ)
20	25.01
25	20.00
30	16.10
35	13.04
40	10.62
45	8.71
50	7.17
55	5.94

Temp(°C)	Resistance(kΩ)
60	4.95
65	4.14
70	3.48
75	2.94
80	2.50
85	2.13
90	1.82
95	1.56

Temp(°C)	Resistance(kΩ)
100	1.35
105	1.16
110	1.01
115	0.88
120	0.77
125	0.67
130	0.59
135	0.52

Resistance Table of Discharge Temperature Sensor for Outdoor (50K)

Temp(°C)	Resistance(kΩ)
-30	911.400
-25	660.8
-20	486.5
-15	362.9
-10	274
-5	209
0	161
5	125.1

Temp(°C)	Resistance(kΩ)
10	98
15	77.35
20	61.48
25	49.19
30	39.61
35	32.09
40	26.15
45	21.43

Temp(°C)	Resistance(kΩ)
50	17.65
55	14.62
60	12.17
65	10.18
70	8.555
75	7.224
80	6.129
85	5.222

Temp(°C)	Resistance(kΩ)
90	4.469
95	3.841
100	3.315
105	2.872
110	2.498
115	2.182
120	1.912
125	1.682



JF00305720



GREE ELECTRIC APPLIANCES, INC. OF ZHUHAI

Add: West Jinji Rd, Qianshan, Zhuhai, Guangdong, China, 519070

Tel: (+86-756) 8522219

Fax: (+86-756) 8669426

E-mail: global@cn.gree.com www.gree.com

For product improvement, specifications and appearance in this manual are subject to change without prior notice.