



Owner's Manual

Original Instructions

Cassette Type Air Conditioner
30,000Btu-36,000Btu



Thank you for choosing our product.

Please read this Owner's Manual carefully before operation and retain it for future reference.

If you have lost the Owner's Manual, please contact the local agent or visit www.gree.com or send an email to global@cn.gree.com for the electronic version.

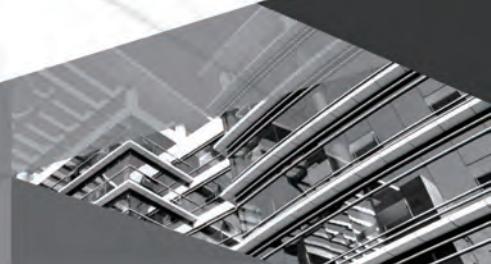

GKH(30)ECXF-D6DNA1G/I
GKH(36)ECXH-D6DNA1A/I

CAS30HP230V1R32AH
CAS36HP230V1R23AH

Contents

1 Safety Precautions	1
2 Outline of the Unit and Main Parts.....	3
3 Operation of remote controller.....	4
3.1 Buttons on remote controller	4
3.2 Introduction for icons on display screen.....	4
3.3 Introduction for buttons on remote controller.....	5
3.4 Function introduction for combination buttons.....	7
3.5 Replacement of batteries in remote controller.....	9
4 Preparative for Installation.....	11
4.1 Selection of the Installation Location	11
4.2 Connection Pipe Requirement	12
4.3 Electrical Requirement	13
4.4 Locking Joint Installation	13
5 Installation of the Unit	14
5.1 Installation of the Indoor Unit.....	14
5.2 Installation of the Connection Pipe.....	16
5.3 Vacuum and Gas Leakage Inspection.....	20
5.4 Installation of the Drain Hose	22
5.5 Installing the Front Panel	25
5.6 Electrical Wiring.....	27
6 Installation of Controller.....	30
7 Test Running.....	30
7.1 Trial Operation and Testing.....	30
8 Troubleshooting and Maintenance	33
8.1 Troubleshooting.....	33
9 SPECIALIST'S MANUAL	34

This appliance is not intended for use by persons (including children) with reduced physical, sensory or mental capabilities or lack of experience and knowledge, unless they have been given supervision or instruction concerning use of the appliance by a person responsible for their safety. Children should be supervised to ensure that they do not play with the appliance.

If it needs to install, move or maintain the air conditioner, please contact dealer or local service center to conduct it at first. Air conditioner must be installed, moved or maintained by appointed unit. Otherwise, it may cause serious damage or personal injury or death.

**DANGER**

Indicates a hazardous situation that, if not avoided, will result in death or serious injury.

**WARNING**

Indicates a hazardous situation that, if not avoided, could result in death or serious injury.

**CAUTION**

Indicates a hazardous situation that, if not avoided, may result in minor or moderate injury.

NOTICE

Indicates important but not hazard-related information, used to indicate risk of property damage.



Indicates a hazard that would be assigned a signal word WARNING or CAUTION.

Manufacturer will bear no responsibilities when personal injury or property loss is caused by the following reasons.

1. Damage the product due to improper use or misuse of the product;
2. Alter, change, maintain or use the product with other equipment without abiding by the instruction manual of manufacturer;
3. After verification, the defect of product is directly caused by corrosive gas;
4. After verification, the defects are due to improper operation during transportation of product;
5. Operate, repair, maintain the unit without abiding by instruction manual or related regulations;
6. After verification, the problem or dispute is caused by the quality specification or performance of parts and components that produced by other manufacturers;
7. The damage is caused by natural calamities, bad using environment or force majeure.







Please read this owner's manual carefully before operating the unit and keep it carefully for consultation.



Only use the air conditioner as instructed in this booklet. These instructions are not intended to cover every possible condition and situation. As with any electrical household appliance, common sense and caution are therefore always recommended for installation, operation and maintenance.

The refrigerant

 <p>Refrigerant Safety Group A2L</p> <p>Appliance filled with flammable magas R32.</p>	 <p>Before install the appliance, read the installation manual first.</p>
 <p>Before use the appliance, read the owner's manual first.</p>	 <p>Before repair the appliance, read the service manual first.</p>

- To realize the function of the air conditioner unit, a special refrigerant circulates in the system. The used refrigerant is the fluoride R32, which is specially cleaned. The refrigerant is flammable and inodorous. Furthermore, it can lead to explosion under certain conditions. But the flammability of the refrigerant is very low. It can be ignited only by fire.
- Compared to common refrigerants, R32 is a nonpolluting refrigerant with no harm to the ozonosphere. The influence upon the greenhouse effect is also lower. R32 has got very good thermodynamic features which lead to a really high energy efficiency. The units there fore need a less filling.

WARNING

- Appliance filled with flammable gas R32.
- Appliance shall be installed, operated and stored in a room with a floor area not less than 7.1m^2 (76.5ft^2)
- The appliance shall be stored in a room without continuously operating ignition sources. (for example: open flames, an operating gas appliance or an operating electric heater.)
- The appliance shall be stored in a well-ventilated area where the room size corresponds to the room area as specified for operation.
- The appliance shall be stored so as to prevent mechanical damage from occurring.
- Ducts connected to an appliance shall not contain an ignition source.
- Keep any required ventilation openings clear of obstruction.
- Do not pierce or burn.
- Be aware that refrigerants may not contain an odour.
- Do not use means to accelerate the defrosting

- process or to clean, other than those recommended by the manufacturer.
- Servicing shall be performed only as recommended by the manufacturer.
 - Should repair be necessary, contact your nearest authorized Service Centre. Any repairs carried out by unqualified personnel may be dangerous.
 - Compliance with national gas regulations shall be observed.
 - Read specialist's manual.



Safety operation of flammable refrigerant

Qualification of workers

Qualification of the working personnel for maintenance, service and repair operations should according to UL 60335-2 -40、CAN/C-SA-C22.2 No. 60335-2-40: 22 Annex HH.. Every working procedure that affects safety means shall only be carried out by competent persons according to Annex HH. Special training additionalto usual refrigerating equipment repair procedures is required when equipment with FLAMMABLE REFRIGERANTS is affected.

Installation notes

- The air conditioner must be installed in a room that is larger than the minimum room area. The minimum room area is shown on the nameplate or following table a.
- It is not allowed to drill hole or burn the connection pipe.
- Leak test is a must after installation.

Safety operation of flammable refrigerant

table a - Minimum room area (m²)

Based on UL 60335-2-40 requirements

The following installation height and area for customer reference

Charge amount (kg)	Height of ventilation opening(m)				
	0.6	1.8	2.2	2.5	3
≤1.836	/	/	/	/	/
1.85	29.4	6.8	5.5	4.9	4.1
1.9	31.0	6.9	5.7	5.0	4.2
1.95	32.7	7.1	5.8	5.1	4.3
2	34.4	7.3	6.0	5.3	4.4
2.05	36.1	7.5	6.1	5.4	4.5
2.1	37.9	7.7	6.3	5.5	4.6
2.15	39.7	7.9	6.4	5.7	4.7
2.2	41.6	8.0	6.6	5.8	4.8
2.3	45.5	8.4	6.9	6.1	5.1
2.4	49.5	8.8	7.2	6.3	5.3
2.5	53.7	9.1	7.5	6.6	5.5
2.6	58.1	9.5	7.8	6.8	5.7
2.7	62.6	9.8	8.1	7.1	5.9
2.8	67.4	10.2	8.4	7.4	6.2
2.9	72.3	10.6	8.7	7.6	6.4

Maintenance notes

- Check whether the maintenance area or the room area meet the requirement of the nameplate.
 - It's only allowed to be operated in the rooms that meet the requirement of the nameplate.
- Check whether the maintenance area is well-ventilated.
 - The continuous ventilation status should be kept during the operation process.

- Check whether there is fire source or potential fire source in the maintenance area.
 - The naked flame is prohibited in the maintenance area; and the "no smoking" warning board should be hanged.
- Check whether the appliance mark is in good condition.
 - Replace the vague or damaged warning mark.

Welding

- If you should cut or weld the refrigerant system pipes in the process of maintaining, please follow the steps as below:
 - a. Shut down the unit and cut power supply
 - b. Eliminate the refrigerant
 - c. Vacuuming
 - d. Clean it with N₂ gas
 - e. Cutting or welding
 - f. Carry back to the service spot for welding
- The refrigerant should be recycled into the specialized storage tank.
- Make sure that there isn't any naked flame near the outlet of the vacuum pump and it's well-ventilated.

Filling the refrigerant

- Use the refrigerant filling appliances specialized for R32. Make sure that different kinds of refrigerant won't contaminate with each other.
- The refrigerant tank should be kept upright at the time of filling refrigerant.
- Stick the label on the system after filling is finished (or haven't finished).
- Don't overfilling.
- After filling is finished, please do the leakage detection before test running; another time of leak detection should be done when it's removed.

Safety instructions for transportation and storage

- Please use the flammable gas detector to check before unload and open the container.
- No fire source and smoking.
- According to the local rules and laws.

Safety operation of flammable refrigerant

Safety of Construction

- For appliances using FLAMMABLE REFRIGERANTS, all joints made in the installation between parts of the REFRIGERATING SYSTEM, with at least one part charged, shall be made in accordance with the following:
 - A brazed, welded, or mechanical connection shall be made before opening the valves to permit refrigerant to flow between the REFRIGERATING SYSTEM parts. A vacuum valve shall be provided to evacuate the interconnecting pipe or any uncharged REFRIGERATING SYSTEM part.
 - Mechanical connectors used indoors shall comply with ISO 14903. When mechanical connectors are reused indoors, sealing parts shall be renewed. When flared joints are reused indoors, the flare part shall be refabricated.
 - Refrigerant tubing shall be protected or enclosed to avoid damage.
 - Flexible refrigerant connectors (such as connecting lines between the indoor and outdoor unit) that may be displaced during NORMAL OPERATION shall be protected against mechanical damage.

Pressure test and leak detect

- After completion of field piping for split systems, the field pipework shall be pressure tested with an inert gas and then vacuum tested prior to refrigerant charging, according to the following requirements.

The minimum test pressure for the low side of the system shall be the low side design pressure and the minimum test pressure for the high side of the system shall be the high side design pressure, unless the high side of the system, cannot be isolated from the low side of the system in which case the entire system shall be pressure tested to the low side design pressure.

- Field-made refrigerant joints indoors shall be tightness tested. The test method shall have a sensitivity of 5 grams per year of refrigerant or better under a pressure of at least 0,25 times the maximum allowable pressure. No leak shall be detected.

Notices for using refrigerant sensor

- The refrigerant sensor can monitor the concentration of R32 refrigerant in real time. When the detected concentration exceeds the threshold, it will trigger the alarm and protection action of the whole unit. During use, avoid oil and dust covering the vent chamber of the refrigerant sensor. If the sensor is abnormal due to special external environment (such as electromagnetic interference, chemical pollution, etc.), please contact our after-sales service team.
- If the sensor life expires or is damaged, and the "FE" code appears on the display of indoor unit, please contact the after-sales service team to replace the refrigerant sensor.
- After the unit is powered on, the refrigerant sensor monitors the concentration of R32 refrigerant in real time. If the detection concentration exceeds the threshold, the indoor unit display displays "EA" code, and buzzer of indoor unit buzzes, the indoor unit fan runs, and the outdoor unit stops.
- If the refrigerant leaks, please open the window for ventilation to reduce the concentration of the refrigerant, and there can be no ignition source nearby. Once you reach the safe area, contact the after-sales service team to troubleshoot possible leaks such as evaporators or connecting pipes and fix them.



Operation and Maintenance

- This appliance can be used by children aged from 8 years and above and persons with reduced physical, sensory or mental capabilities or lack of experience and knowledge if they have been given supervision or instruction concerning use of the appliance in a safe way and understand the hazards involved.
- Children shall not play with the appliance.
- Cleaning and user maintenance shall not be made by children without supervision.
- Do not connect air conditioner to multi-purpose socket. Otherwise, it may cause fire hazard.
- Do not disconnect power supply when cleaning air conditioner. Otherwise, it may cause electric shock.
- If the supply cord is damaged, it must be replaced by the manufacturer, its service agent or similarly qualified persons in order to avoid a hazard.
- Do not wash the air conditioner with water to avoid electric shock.
- Do not spray water on indoor unit. It may cause electric shock or malfunction.
- After removing the filter, do not touch fins to avoid injury.
- Do not use fire or hair dryer to dry the filter to avoid deformation or fire hazard.
- Maintenance must be performed by qualified professionals. Otherwise, it may cause personal injury or damage.
- Do not repair air conditioner by yourself. It may cause electric shock or damage. Please contact dealer when you need to repair air conditioner.
- Do not extend fingers or objects into air inlet or air outlet. It may cause personal injury or damage.
- Do not block air outlet or air inlet. It may cause malfunction.
- Do not spill water on the remote controller, otherwise the remote controller may be broken.
- When below phenomenon occurs, please turn off air conditioner and disconnect power immediately, and then contact the dealer or qualified professionals for service.
 - Power cord is overheating or damaged.
 - There's abnormal sound during operation.
 - Circuit break trips off frequently.
 - Air conditioner gives off burning smell.
 - Indoor unit is leaking.



- If the air conditioner operates under abnormal conditions, it may cause malfunction, electric shock or fire hazard.
- When turning on or turning off the unit by emergency operation switch, please press this switch with an insulating object other than metal.
- Do not step on top panel of outdoor unit, or put heavy objects. It may cause damage or personal injury.
- For appliances made up of more than one factory made assembly specified by the manufacturer to be used together, instructions shall be provided for completing the assembly to ensure compliance with the requirements.

Attachment

- Installation must be performed by qualified professionals. Otherwise, it may cause personal injury or damage.
- Must follow the electric safety regulations when installing the unit.
- According to the local safety regulations, use qualified power supply circuit and circuit break.
- Do install the circuit break. If not, it may cause malfunction.
- Means for disconnection must be incorporated in the fixed wiring in accordance with the wiring rules.
- Including an circuit break with suitable capacity, please note the following table. Air switch should be included magnet buckle and heating buckle function, it can protect the circuit-short and overload.
- Air Conditioner should be properly grounded. Incorrect grounding may cause electric shock.
- Don't use unqualified power cord.
- Make sure the power supply matches with the requirement of air conditioner. Unstable power supply or incorrect wiring may result in electric shock, fire hazard or malfunction. Please install proper power supply cables before using the air conditioner.
- Properly connect the live wire, neutral wire and grounding wire of power socket.
- Be sure to cut off the power supply before proceeding any work related to electricity and safety.
- Do not put through the power before finishing installation.
- If the supply cord is damaged, it must be replaced by the manufacturer, its service agent or similarly qualified persons in order to avoid a hazard.
- The temperature of refrigerant circuit will be high, please keep the interconnection cable away from the copper tube.



- The appliance shall be installed in accordance with national wiring regulations.
- Installation must be performed in accordance with the requirement of NEC and CEC by authorized personnel only.
- The air conditioner is the first class electric appliance. It must be properly grounding with specialized grounding device by a professional. Please make sure it is always grounded effectively, otherwise it may cause electric shock.
- The yellow-green wire in air conditioner is grounding wire, which can't be used for other purposes.
- The grounding resistance should comply with national electric safety regulations.
- The appliance must be positioned so that the plug is accessible.
- All wires of indoor unit and outdoor unit should be connected by a professional.
- If the length of power connection wire is insufficient, please contact the supplier for a new one. Avoid extending the wire by yourself.
- For the air conditioner with plug, the plug should be reachable after finishing installation.
- For the air conditioner without plug, an circuit break must be installed in the line.
- If you need to relocate the air conditioner to another place, only the qualified person can perform the work. Otherwise, it may cause personal injury or damage.
- Select a location which is out of reach for children and far away from animals or plants. If it is unavoidable, please add the fence for safety purpose.
- The indoor unit should be installed close to the wall.
- Before operation, please confirm whether power specification complies with that on nameplate.
- Before cleaning or maintaining the air conditioner, please turn off air conditioner and pull out the power plug.
- Make sure the power cord hasn't been pressed by hard objects.
- Do not pull or drag the power cord to pull out the power plug or move the air conditioner.
- Do not insert or pull out the power plug with wet hands. Please use the grounded power. Make sure the grounding is reliable.
- If the SUPPLY CORD is damaged, it must be replaced by the manufacturer, its service agent or similarly qualified persons in order to avoid a hazard.
- If abnormal condition occurs (e. g. burned smell), please disconnect power at once and then contact local dealer.
- When nobody is taking care of the unit, please turn it off and remove the power plug or disconnect power.





- Do not splash or pour water on air conditioner. Otherwise, it may cause short circuit or damage to air conditioner.
- Prohibit operating heating equipment around the air conditioner.
- Prohibit operating the unit in the bathroom or laundry room.
- Far away from fire source, inflammable and explosive objects.
- Keep children from playing or climbing on the air conditioner.
- Do not put or hang dripping objects above the air conditioner.
- Do not repair or disassemble the air conditioner by yourself.
- Do not block air outlet or air inlet.
- Prohibit inserting any objects into the air conditioner.
- Do not through sundries into the air duct. If there are sundries get into the air duct, please contact the professionals to deal with it.
- Do not use an extension cord.
- A fuse or circuit breaker should be added at the product circuit. Please refer to the MOP value on the nameplate for the detailed specification.
- The appliance shall be installed in accordance with national wiring regulations.
- If a STATIONARY APPLIANCE is not fitted with a SUPPLY CORD and a plug, an all-pole disconnection switch having a contact separation of at least 3mm in all poles should be connected in fixed wiring.

Special Functions and Instructions

Sensor	Function
Temperature sensor	Detect indoor and outdoor ambient temperature, tube temperature of evaporators and condensers, and discharge temperature of outdoor unit.
Infrared receiver	Receive the infrared signal sent from the remote controller.

1 Safety Precautions

 WARNING!	This mark indicates procedures which, if improperly performed, might lead to the death or serious injury of the user.
 CAUTION!	This mark indicates procedures which, if improperly performed, might possibly result in personal harm to the user, or damage to property.

 WARNING!	
(1)	This product can't be installed at corrosive, inflammable or explosive environment or the place with special requirements, such as kitchen. Otherwise, it will affect the normal operation or shorten the service life of the unit, or even cause fire hazard or serious injury. As for above special places, please adopt special air conditioner with anti-corrosive or anti-explosion function.
(2)	Installation should be left to the dealer or another professional. Improper installation may cause water leakage, electrical shock, or fire.
(3)	Install the air conditioner according to the instructions given in this manual. Incomplete installation may cause water leakage, electrical shock, or fire.
(4)	Be sure to use the supplied or specified installation parts. Use of other parts may cause the unit to come to lose, water leakage, electrical shock, or fire.
(5)	Install the air conditioner on a solid base that can support the weight of the unit. An inadequate base or incomplete installation may cause injury in the event the unit falls off the base.
(6)	Electrical work should be carried out in accordance with the installation manual and the national electrical wiring rules or code of practice. Insufficient capacity or incomplete electrical work may cause electrical shock or fire.
(7)	Be sure to use a dedicated power circuit. Never use a power supply shared by another appliance.
(8)	For wiring, use a cable length enough to cover the entire distance with no connection. Do not use an extension cord. Do not put other loads on the power supply, use a dedicated power circuit. (Failure to do so may cause abnormal heat, electric shock or fire.)
(9)	Use the specified types of wires for electrical connections between the indoor and outdoor units. Firmly clamp the interconnecting wires so their terminals receive no external stresses. Incomplete connections or clamping may cause terminal overheating or fire.
(10)	After connecting interconnecting and supply wiring be sure to shape the cables so that they do not put undue force on the electrical covers or panels. Install covers over the wires. Incomplete cover installation may cause terminal overheating, electrical shock, or fire.
(11)	If any refrigerant has leaked out during the installation work, ventilate the room. (The refrigerant produces a toxic gas if exposed to flames.)
(12)	After all installation is complete, check to make sure that no refrigerant is leaking out. (The refrigerant produces a toxic gas if exposed to flames.)



WARNING!

- (13) During pump-down, stop the compressor before removing the refrigerant piping. If the compressor is still running and the stop valve is open during pump-down, air will be sucked in when the refrigerant piping is removed, causing abnormal pressure in the freezer cycle which will lead to breakage and even injury.
- (14) During installation, attach the refrigerant piping securely before running the compressor. If the compressor is not attached and the stop valve is open during pump-down, air will be sucked in when the compressor is run, causing abnormal pressure in the freezer cycle which will lead to breakage and even injury.
- (15) Be sure to establish an earth. Do not earth the unit to a utility pipe, arrester, or telephone earth. Incomplete earth may cause electrical shock, or fire. A high surge current from lightning or other sources may cause damage to the air conditioner.
- (16) Be sure to install an earth leakage breaker. Failure to install an earth leakage breaker may result in electric shocks, or fire.
- (17) This appliance is not intended for use by persons (including children) with reduced physical, sensory or mental capabilities, or lack of experience and knowledge, unless they have been given supervision or instruction concerning use of the appliance by a person responsible for their safety. Children should be supervised to ensure that they do not play with the appliance.
- (18) Correct Disposal of this product
- (19) Installation must be performed in accordance with the requirement of NEC and CEC by authorized personnel only.



CAUTION!

- (1). Do not install the air conditioner in a place where there is danger of exposure to inflammable gas leakage. If the gas leaks and builds up around the unit, it may catch fire.
- (2). Establish drain piping according to the instructions of this manual. Inadequate piping may cause flooding.
- (3). Tighten the flare nut according to the specified method such as with a torque wrench. If the flare nut is tightened too hard, the flare nut may crack after a long time and cause refrigerant leakage.

2 Outline of the Unit and Main Parts

Indoor

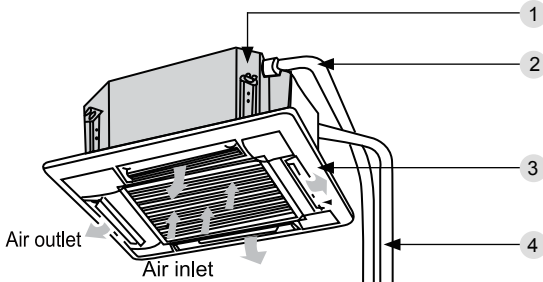

5

6

Outdoor

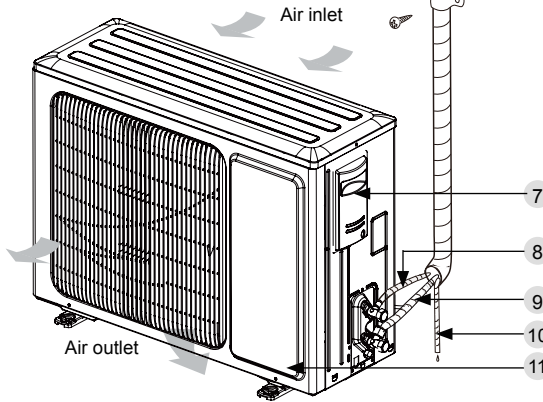

- 1. Drainage device
- 2. Drainage pipe
- 3. Air flow flap
- 4. Connection pipe
- 5. Wired Controller(optional)
- 6. Remote controller
- 7. Big handle
- 8. Liquid Pipe
- 9. Gas pipe
- 10. Drainage pipe
- 11. Front Board

Fig.1

3 Operation of remote controller

3.1 Buttons on remote controller



3.2 Introduction for icons on display screen

	Quiet	
	Set fan speed	
	Turbo mode	
	Send signal	
Operation mode		Auto mode
		Cool mode
		Dry mode
		Fan mode
		Heat mode
	X-FAN function	
	Power limiting operation	
	Set temperature	
	Indoor ambient temp.	
ON/OFF	TIMER ON / TIMER OFF	
	Set time	
	Left & right swing	
	Up & down swing	
	Child lock	
	Air function	
	Health function	
WIFI	WiFi function	
	LED	
	I feel	
	Sleep mode	

3.3 Introduction for buttons on remote controller

NOTE

- This is a general use remote controller. It could be used for the air conditioner with multifunction. For the functions which the model doesn't have, if press the corresponding button on the remote controller, the unit will keep the original running status.
- After putting through the power, the air conditioner will give out a sound. Power indicator "⏻" is ON. After that, you can operate the air conditioner by using remote controller.
- Under on status, pressing the button on the remote controller, the signal icon "📶" on the display of remote controller will blink once and the air conditioner will give out a "di" sound, which means the signal has been sent to the air conditioner.

⏻ On/Off button

Press this button to turn on the unit. Press this button again to turn off the unit.

Mode button

Press this button to select your required operation mode.



- When selecting auto mode, air conditioner will operate automatically according to the sensed temperature. Press "Fan" button can adjust fan speed. Press "🌀" / "🌀" button can adjust fan blowing angle.
- After selecting cool mode, air conditioner will operate under cool mode. Press " + " or " - " button to adjust set temperature. Press "Fan" button to adjust fan speed. Press "🌀" / "🌀" button to adjust fan blowing angle.
- When selecting dry mode, the air conditioner operates at low speed under dry mode. Under dry mode, fan speed can't be adjusted. Press "🌀" / "🌀" button to adjust fan blowing angle.
- When selecting fan mode, the air conditioner will only blow fan, no cooling and no heating. Press "Fan" button to adjust fan speed. Press "🌀" / "🌀" button to adjust fan blowing angle.

- When selecting heat mode, the air conditioner operates under heat mode. Press " + " or " - " button to adjust set temperature. Press "Fan" button to adjust fan speed. Press "🌀" / "🌀" button to adjust fan blowing angle.

NOTE

- For preventing cold air, after starting up heat mode, indoor unit will delay 1~5 minutes to blow air (Actual delay time depends on indoor ambient temperature).
- Set temperature range from remote controller: 16~30°C (61-86°F).
- This mode indicator is not available for some models.
- Cooling only unit won't receive heat mode signal. If setting heat mode with remote controller, press " On/Off " button can't start up the unit.

Fan button

This button is used for setting Fan Speed in the sequence that goes from AUTO, 🌀, ■, ■■, ■■■, ■■■■, ■■■■■ to 🌀, then back to Auto.



- Low speed ■■ Low-Medium speed ■■■ Medium speed ■■■■ Medium-High speed ■■■■■ High speed
- 🌀 Turbo speed 🌀 Quiet speed

NOTE

- It's low fan speed under dry mode.
- X-FAN function Hold fan speed button for 2s in cool or dry mode, the icon "🌀" is displayed and the indoor fan will continue operation for a few minutes in order to dry the indoor unit even though you have turned off the unit. After energization, X-FAN OFF is defaulted. X-FAN is not available in auto, fan or heat mode.
This function indicates that moisture on evaporator of indoor unit will be blowed after the unit is stopped to avoid mould.
- Having set X-FAN function on: After turning off the unit by pressing " On/Off " button indoor fan will continue running for a few minutes. at low speed. In this period, Hold fan speed button for 2s to stop indoor fan directly.
- Having set X-FAN function off: After turning off the unit by pressing " On/Off " button, the complete unit will be off directly.

DC Inverter Free match Series Cassette Type Unit

+ / - button

Press "+" or "-" button once increase or decrease set temperature 1°C(°F). Holding "+" or "-" button, 2s later, set temperature on remote controller will change quickly. On releasing button after setting is finished, temperature indicator on indoor unit will change accordingly.

Wifi button

Press "Wifi" button to turn on WiFi function, "Wifi" icon will be displayed on the remote controller; Hold "Wifi" button for 5s to turn off WiFi function and "Wifi" icon will disappear. Under off status, press "Mode" and "Wifi" buttons simultaneously for 1s, WiFi module will restore factory settings.

NOTE

- This function is only available for some models.

Health button

Press this button to turn on or turn off the health and air functions in operation status. Press this button for the first time to start air function; LCD displays "🏠". Press the button for the second time to start health and air functions simultaneously; LCD displays "🏠" and "🌳". Press this button for the third time to quit health and air functions simultaneously. Press the button for the fourth time to start health function; LCD display "🌳". Press this button again to repeat the operation above.

NOTE

- This function is only available for some models.

UD-swing button

Press this button can select up & down swing angle. Fan blow angle can be selected circularly as below:

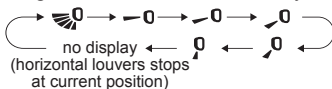

- When selecting "🏠", air conditioner is blowing fan automatically. Horizontal louver will automatically swing up & down at maximum angle.
- When selecting "🏠", "🏠", "🏠", "🏠", "🏠", air conditioner is blowing fan at fixed position. Horizontal louver will stop at the fixed position.
- Hold "🏠" button above 2s to set your required

swing angle. When reaching your required angle, release the button.

NOTE

- Press this button continuously more than 2s, the main unit will swing back and forth from up to down, and then loosen the button, the unit will stop swinging and present position of guide louver will be kept immediately.
- Under swing up and down mode, when the status is switched from off to 🏠, if press this button again 2s later, 🏠 status will switch to off status directly; if press this button again within 2s, the change of swing status will also depend on the circulation sequence stated above.

LR-swing button

Press this button can select left & right swing angle. Fan blow angle can be selected circularly as below:

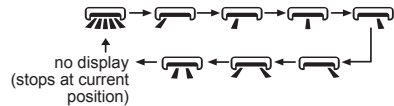

NOTE

- Press this button continuously more than 2s, the main unit will swing back and forth from left to right, and then loosen the button, the unit will stop swinging and present position of guide louver will be kept immediately.
- Under swing left and right mode, when the status is switched from off to 🏠, if press this button again 2s later, 🏠 status will switch to off status directly; if press this button again within 2s, the change of swing status will also depend on the circulation sequence stated above.
- This function only applicable for some models.





⌚ Clock button

Press this button to set clock time. "⌚" icon on remote controller will blink. Press "+" or "-" button within 5s to set clock time. Each pressing of "+" or "-" button, clock time will increase or decrease 1 minute. If hold "+" or "-" button, 2s later, time will change quickly. Release this button when reaching your required time. Press "Clock" button to confirm the time. "⌚" icon stops blinking.

NOTE

- Clock time adopts 24-hour mode.
- The interval between two operations can't exceed 5s. Otherwise, remote controller will quit setting status. Operation for TIMER ON/TIMER OFF is the same.

Timer on / Timer off button

- TIMER ON button**
 "TIMER ON" button can set the time for timer on. After pressing this button, " " icon disappears and the word "ON" on remote controller blinks. Press "+" or "-" button to adjust TIMER ON setting. After each pressing "+" or "-" button, TIMER ON setting will increase or decrease 1min. Holding "+" or "-" button, 2s later, the time will change quickly until reaching your required time.
 Press "TIMER ON" to confirm it. The word "ON" will stop blinking. " " icon resumes displaying. Cancel TIMER ON: Under the condition that TIMER ON is started up, press "TIMER ON" button to cancel it.
- TIMER OFF button**
 "TIMER OFF" button can set the time for timer off. After pressing this button, " " icon disappears and the word "OFF" on remote controller blinks. Press "+" or "-" button to adjust TIMER OFF setting. After each pressing "+" or "-" button, TIMER OFF setting will increase or decrease 1min. Holding "+" or "-" button, 2s later, the time will change quickly until reaching your required time.
 Press "TIMER OFF" and the word "OFF" will stop blinking. " " icon resumes displaying. Under the condition that TIMER OFF is started up, press "TIMER OFF" button to cancel it.

NOTE

- Under on and off status, you can set TIMER OFF or TIMER ON simultaneously.
- Before setting TIMER ON or TIMER OFF, please adjust the clock time.
- When turning on TIMER ON or TIMER OFF function, set this function valid all the time and the air conditioner will be turned on or turned off at set temperature every day. On/Off button has no affect to setting. If this function is not required, use the remote controller to cancel it.

Light button

Press this button to control the LED status on the display, the circulation change is as follow:

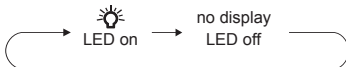

3.4 Function introduction for combination buttons



Energy-saving function

Under cooling mode, press "Mode" and "Clock" buttons simultaneously to start up or turn off energy-saving function. When energy-saving function is started up, "SE" will be shown on remote controller, and air conditioner will adjust the set temperature automatically according to ex-factory setting to reach to the best energy-saving effect. Press "Mode" and "Clock" buttons simultaneously again to exit energy-saving function.

NOTE

- Under energy-saving function, fan speed is defaulted at auto speed and it can't be adjusted.
- Under energy-saving function, set temperature can't be adjusted.
- Sleep function and energy-saving function can't operate at the same time. If energy-saving function has been set under cool mode, press "Clock" and "Light" buttons simultaneously will cancel energy-saving function. If sleep function has been set under cool mode, start up the energy-saving function will cancel sleep function.

Child lock function

Hold "On/Off" and "-" buttons simultaneously for 3s to turn on or turn off child lock function. When child lock function is on, " " icon is displayed on remote controller. If you operate the remote controller, the " " icon will blink three times without sending signal to the unit.

Temperature display switchover function



Under OFF status, hold "Mode" and "-" buttons simultaneously for 3s to switch temperature display between °C and °F.

function

 function is for limiting power of the whole unit. Press "Mode" and "Light" buttons simultaneously, the remote controller will circularly display as the

following:



- Maximum power limited under the  mode is lower than that of  mode.
- If you want to cancel the power limiting function, press "Mode" and "Light" buttons simultaneously till the icon in remote controller is not displayed.
- When the remote controller is turned off, power limiting function is cancelled. If you want to activate the function, please repress "Mode" and "Light" buttons simultaneously.
- If the current power is lower than the maximum power of  mode, then the power will not be limited after entering into such mode.
- For the model with one outdoor unit and two indoor units, if any one of indoor units enters into power limiting function, the outdoor unit will enter into the set limiting power mode of indoor unit; when two indoor units enter into power limiting mode, then the power of outdoor unit will be limited according to the lower power of the two indoor units.

NOTE

- This function is only available for some models.

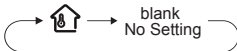

Indoor ambient temperature

By holding "On/Off" and "" buttons simultaneously, you can see indoor ambient temperature on indoor unit's display. The setting on remote controller is selected circularly as below:



- When selecting "" with remote controller, temperature indicator on indoor unit displays indoor ambient temperature.

Clean reminder function of filter

The reminder function is defaulted to be OFF. Hold "On/Off" and "" buttons simultaneously for 5s to turn it on. The buzzer will give out sound for 0.5s and the dual-8 nixie tube on the display will be on for 3s; Once the reminder function is turned on, when the air conditioner has reached to the set time, the dual-8 nixie tube will flash about 30s when the unit is turned on each time to remind the user to clean the filter; you can turn off this cycle reminder by holding "On/Off" and "" buttons simultaneously for 5s and then the air conditioner will count time again.

NOTE

- Once the reminder function is turned on, only this cycle reminder can be cleared.
- This function is only available for some models.

Auto clean function

Under unit off status, hold "Mode" and "" buttons simultaneously for 5s to turn on or turn off the auto clean function. When the auto clean function is turned on, indoor unit displays "CL". During the auto clean process of evaporator, the unit will perform fast cooling or fast heating. There may be some noise, which is the sound of flowing liquid or thermal expansion or cold shrinkage. The air conditioner may blow cool or warm air, which is a normal phenomenon. During cleaning process, please make sure the room is well ventilated to avoid affecting the comfort.

NOTE

- The auto clean function can only work under normal ambient temperature. If the room is dusty, clean it once a month; if not, clean it once every three months. After the auto clean function is turned on, you can leave the room. When auto clean is finished, the air conditioner will enter standby status.
- This function is only available for some models.

Night mode

Under cooling or heating mode, when turning on sleep mode and turn to low speed or quiet notch, the outdoor unit would enter into night mode.

NOTE

- When you feel that the cooling and heating effect is poor, please press "Fan" button to other fan speed or press "Clock" and "Light" buttons simultaneously to exit the night mode.
- The night mode can only work under normal ambient temperature.
- This function is only available for some models.

I FEEL function

Press "Health" and "+" buttons simultaneously to start I FEEL function and "" will be displayed on the remote controller. After this function is set, the remote controller will send the detected ambient temperature to the controller and the unit will automatically adjust the indoor temperature

DC Inverter Free match Series Cassette Type Unit

according to the detected temperature. Press "Health" and "+" buttons simultaneously again to turn off I FEEL function and "⏸" will disappear.

- Please put the remote controller near user when this function is set. Do not put the remote controller near the object of high temperature or low temperature in order to avoid detecting inaccurate ambient temperature. When I FEEL function is turned on, the remote controller should be put within the area where indoor unit can receive the signal sent by the remote controller.

Sleep function

Press "Clock" and "Light" buttons simultaneously, can select Sleep 1 (☺), Sleep 2 (☺), Sleep 3 (☺) and cancel the Sleep, circulate between these, after electrified, Sleep Cancel is defaulted.

- Sleep 1 is Sleep mode 1, in Cool modes: sleep status after run for one hour, the main unit setting temperature will increase 1, two hours, setting temperature increased 2, then the unit will run at this setting temperature; In Heat mode: sleep status after run for one hour, the setting temperature will decrease 1, two hours, setting temperature will decrease 2, then the unit will run at this setting temperature.
- Sleep 2 is sleep mode 2, that is air conditioner will run according to the presetting a group of sleep temperature curve.
- Sleep 3 the sleep curve setting under Sleep mode by DIY;
(1) Under Sleep 3 mode, press "Health" button for a long time, remote controller enters into user individuality sleep setting status, at this time, the time of remote controller will display "1HOUR", the setting temperature "88" will display the corresponding temperature of last setting sleep curve and blink (The first entering will display according to the initial curve setting value of original factory);
(2) Adjust "+" and "-" button, could change the corresponding setting temperature, after adjusted, press "Health" button for confirmation;
(3) At this time, 1hour will be automatically increased at the timer position on the remote control, (that are "2HOUR" or "3HOUR" or "8HOUR"), the place of setting temperature "88" will display the corresponding temperature of last setting sleep curve and blink;
(4) Repeat the above step (2)~(3) operation, until 8 hours temperature setting finished, sleep curve setting finished, at this time, the remote controller will resume the original timer display; temperature display will resume to original setting temperature.

- Sleep 3 the sleep curve setting under Sleep mode by DIY could be inquired:

The user could accord to sleep curve setting method to inquire the presetting sleep curve, enter into user individuality sleep setting status, but do not change the temperature, press "Health" button directly for confirmation. Note: In the above presetting or enquiry procedure, if continuously within 10s, there is no button pressed, the sleep curve setting within 10s, there is no button pressed, the sleep curve setting status will be automatically quit and resume to display the original displaying. In the presetting or enquiry procedure, press "On/Off" button, "Mode" button, "Clock" and "Light" buttons simultaneously, the sleep curve setting or enquiry status will quit similarly.

8°C heating function

Under heat mode, press "Mode" and "Clock" buttons simultaneously to start up or turn off 8°C heating function. When this function is started up, "8°C" will be shown on remote controller, and the air conditioner keep the heating status at 8°C. Press "Mode" and "Clock" buttons simultaneously again to exit 8°C heating function.

NOTE

- Under 8°C heating function, fan speed is defaulted at auto speed and it can't be adjusted.
- Under 8°C heating function, set temperature can't be adjusted.
- Sleep function and 8°C heating function can't operate at the same time. If 8°C heating function has been set under heat mode, press "Clock" and "Light" buttons simultaneously will cancel 8°C heating function. If sleep function has been set under heat mode, start up the 8°C heating function will cancel sleep function.
- Under °F temperature display, the remote controller will display 46°F heating.

3.5 Replacement of batteries in remote controller

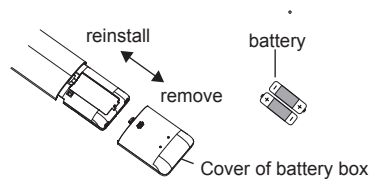

1. Press the back side of remote controller marked with "⊞", as shown in the fig, and then push out the cover of battery box along the arrow direction.
2. Replace two 7# (AAA 1.5V) dry batteries, and make sure the position of "+" polar and "-" polar are correct.
3. Reinstall the cover of battery box.

NOTICE

- During operation, point the remote control signal sender at the receiving window on indoor unit.
- The distance between signal sender and receiving window should be no more than 8m, and there should be no obstacles between them.
- Signal may be interfered easily in the room where there is fluorescent lamp or wireless telephone; remote controller should be close to indoor unit during operation.
- Replace new batteries of the same model when replacement is required.
- When you don't use remote controller for a long time, please take out the batteries.
- If the display on remote controller is fuzzy or there's no display, please replace batteries.

4 Preparative for Installation

4.1 Selection of the Installation Location



The unit must be installed where strong enough to withstand the weight of the unit and fixed securely, otherwise the unit would topple or fall off.

- ① . Do not install where there is the danger of combustible gas leakage.
- ② . Do not install the unit near heat source of heat, steam, or flammable gas.
- ③ . Children under 10 years old must be supervised not to operate the unit.

Decide the installation location with the customer as follows:

4.1.1 Indoor Unit

Select an installation site where the following conditions are fulfilled and that meets your customer's approval.

- (1). Obstruct should be put away from the intake or outlet vent of the indoor unit so that the airflow can be blown through all the room.
- (2). Make sure that the installation meets the requirement of the schematic diagram of installation spaces.
- (3). Select the place where can stand 4 times of the weight of the indoor unit and would not increase the operating noise and vibration.
- (4). The horizontality of the installation place should be guaranteed.
- (5). Select the place where is easy to drain out the condensate water, and connect with outdoor unit.
- (6). Make sure that there are enough space for care and maintenance, and the height fall between the indoor unit and ground is above 2500mm.
- (7). When installing the suspension bolt, check if the installation place can stand 4 times of the weight of the unit. If not, reinforce it before installation.

Note: There will be large amount of greasy dirt accumulated on the fan, heat exchanger and water pump located in the dinning room and kitchen, which would reduce the capacity of the heater exchanger, lead to leakage and abnormal operation of the water pump.

Unit: mm(inch)

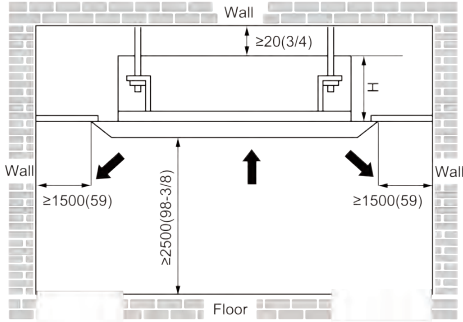
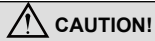

Fig.2

Table 2

Model	H
30K、36K	10 7/8

4.2 Connection Pipe Requirement



The maximum length of the connection pipe is listed in the table below. Do not place the units between which the distance exceeds the maximum length of the connection pipe.

Table 3

Model \ Item	Size of Fitting Pipe(Inch)		Drainage pipe(Outer Diameter × wall thickness) (mm)
	Liquid	Gas	
30K、36K	1/4	5/8	Φ25×1.5

The connection pipe should be insulated with proper water-proof insulating material.

The pipe wall thickness shall be 0.5-1.0mm and the pipe wall shall be able to withstand the pressure of 6.0 MPa. The longer the connecting pipe, the lower the cooling and heating effect performs.

4.3 Electrical Requirement

Power Cord Size and Fuse Capacity

Table 4

Indoor Units	Power Supply	Fuse Capacity	Min. Power Supply Cord
	V/Ph/Hz	A	
30K、36K	208/230V~ 60Hz	3.15	4xAWG14

Notes:

- ① . The fuse is located on the main board.
- ② . Install the disconnect device with a contact gap of at least 3mm in all poles nearby the units (Both indoor unit and outdoor unit).The appliance must be positioned so that the plug is accessible.
- ③ . The specifications of the power cable listed in the table above are determined based on the maximum power (maximum amps) of the unit.
- ④ . The specifications of the power cable listed in the table above are applied to the conduit-guarded multi-wire copper cable (like, YJV copper cable, consisting of PE insulated wires and a PVC cable jacket) used at 40°C and resistible to 90°C(see IEC 60364-5-52). If the working condition changes, they should be modified according to the related national standard.

4.4 Locking Joint Installation

When the power cable and communication line of the unit are connected, the power cable and communication line need to be fixed through the side panel locking connector. The fixing process is as follows.

- (1) Attach the locking joint to the locking joint bracket.

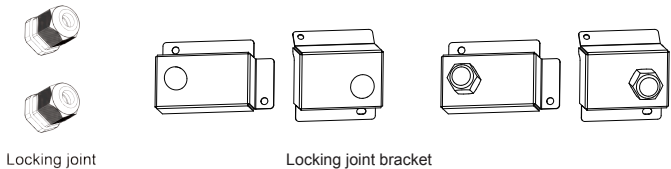

Fig.4.4.1

- (2) Power cable (communication line) passes through the locking joint and the side plate engineering line over the wire crossing hole.
- (3) Finally, reattach the locking joint bracket to the side panel.

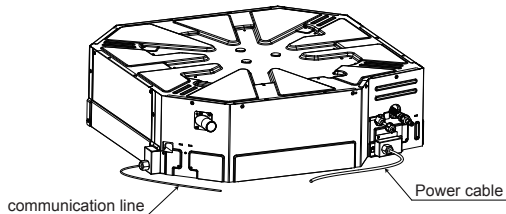

Fig.4.4.2

5 Installation of the Unit

5.1 Installation of the Indoor Unit

5.1.1 Indoor unit dimension

In order to make the front panel cover $13/16"$ of the ceiling, the distance between the ceiling and the unit should be $1\ 3/8"$ or less. If the distance between the ceiling and the unit is above $1\ 3/8"$, add some ceiling material to shorten the distance. See the following diagram.

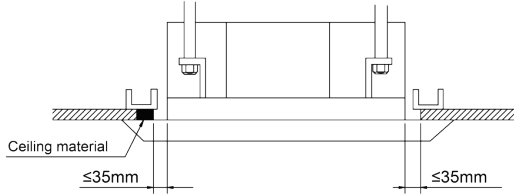

Fig.2

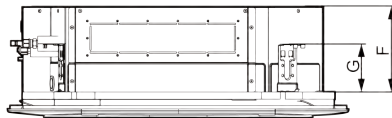
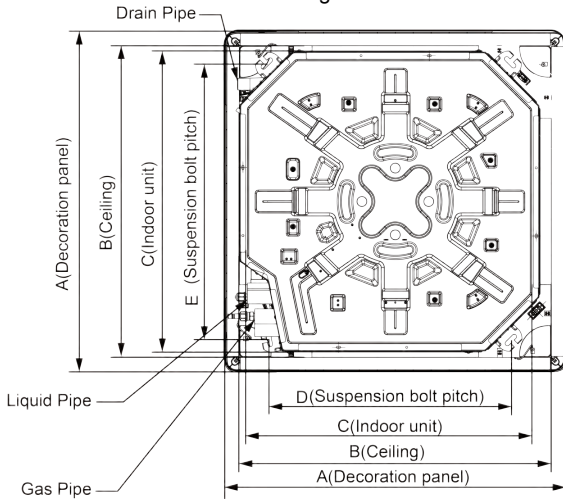

Fig.3

Table 5

Unit:inch

Model	Dimensions						
	A	B	C	D	E	F	G
30K、36K	37 3/8	35 1/16	33 1/16	26 3/4	30 3/4	9 7/16	5 5/16

5.1.2 Installing the Main Body Unit

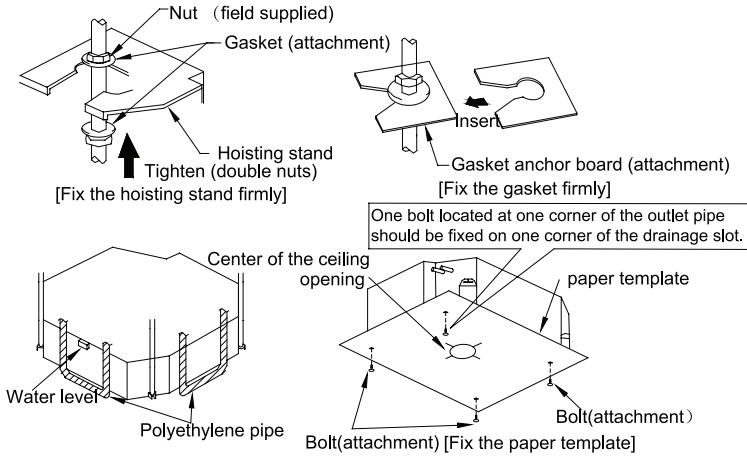

Fig.4

- (1). Install the hoisting stand on the hoisting screw by using nuts and gaskets at both the upper and lower sides of the hoisting stand. To prevent the gasket from breaking off, a gasket anchor board can be helpful.
- (2). Install the paper template on the unit, and fix the drain pipe at the outlet vent.
- (3). Adjust the unit to the best position.
- (4). Check if the unit is installed horizontally at four directions. If not, the water pump and the float switch would function improperly and even lead to water leakage.
- (5). Remove the gasket anchor board and tighten the nut remained.
- (6). Remove the paper template.

Notes:

1. Drilling of ceiling opening and installation of air conditioner must be performed by professionals!
2. Please refer to the installation cardboard for the dimension of drilling hole of lifting screw of cassette unit.

5.1.3 Installing the Suspension Bolts

- (1). Using the installation template, drill holes for bolts (four holes). (Fig. 5)
- (2). Install the bolts to the ceiling at a place strong enough to hang the unit. Mark the bolt positions from the installation template. With a concrete drill, drill for 12.7mm diameter holes. (Fig.6)
- (3). Insert the anchor bolts into the drilled holes, and drive the pins completely into the anchor bolts with a hammer. (Fig.7)

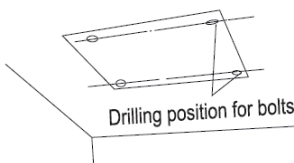

Fig.5

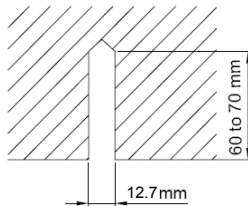

Fig.6

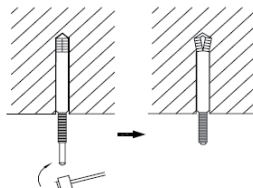

Fig.7

5.1.4 Leveling

The water level test must be done after installing the indoor unit to make the unit is horizontal, as shown below.

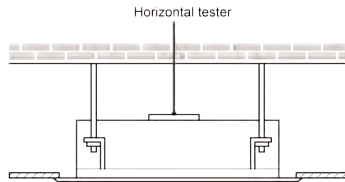

Fig.8

5.2 Installation of the Connection Pipe

5.2.1 Flare Processing

- (1). Cut the connection pipe with the pipe cutter and remove the burrs.
- (2). Hold the pipe downward to prevent cuttings from entering the pipe.
- (3). Remove the flare nuts at the stop valve of the outdoor unit and inside the accessory bag of the indoor unit, then insert them to the connection pipe, after that, flare the connection pipe with a flaring tool.
- (4). Check if the flare part is spread evenly and there are no cracks (see Fig.9).

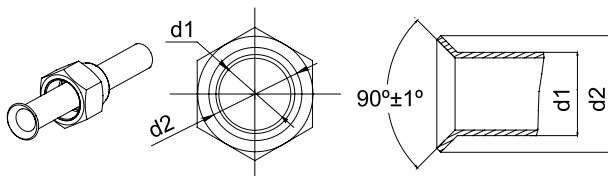

Fig.9

5.2.2 Bending Pipes

- (1). The pipes are shaped by your hands. Be careful not to collapse them.

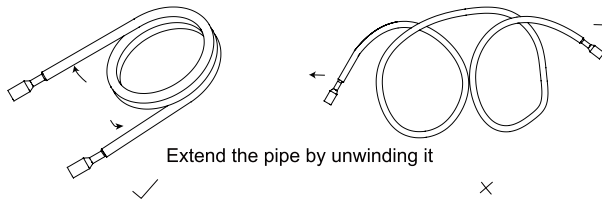
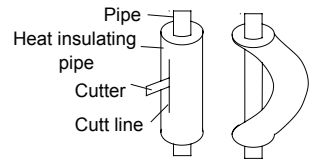

Fig.10

- (2). Do not bend the pipes in an angle more than 90°.
- (3). When pipes are repeatedly bent or stretched, the material will harden, making it difficult to bend or stretch them any more. Do not bend or stretch the pipes more than three times.



- (4). When bending the pipe, do not bend it as is. The pipe will be collapsed. In this case, cut the heat insulating pipe with a sharp cutter as shown in Fig.11, and bend it after exposing the pipe. After bending the pipe as you want, be sure to put the heat insulating pipe back on the pipe, and secure it with tape.

⚠ CAUTION!

- ① . To prevent breaking of the pipe, avoid sharp bends. Bend the pipe with a radius of curvature of 150 mm or over.
- ② . If the pipe is bent repeatedly at the same place, it will break.

5.2.3 Connecting the Pipe at the Indoor Unit Side

Detach the caps and plugs from the pipes.

⚠ CAUTION!

- ① . Be sure to apply the pipe against the port on the indoor unit correctly. If the centering is improper, the flare nut cannot be tightened smoothly. If the flare nut is forced to turn, the threads will be damaged.
- ② . Do not remove the flare nut until the connection pipe is to be connected so as to prevent dust and impurities from coming into the pipe system.

When connecting the pipe to the unit or removing it from the unit, please do use both the spanner and the torque wrench.(Fig.12)

When connecting, smear both inside and outside of the flare nut with refrigeration oil, screw it hand tight and then tighten it with the spanner.

Refer to Table 6 to check if the wrench has been tightened properly (too tight would mangle the nut and lead to leakage).

Examine the connection pipe to see if it leaks, then take the treatment of heat insulation, as shown in the Fig.12.

Use the medium-sized sponge to insulate the coupler of the gas pipe.

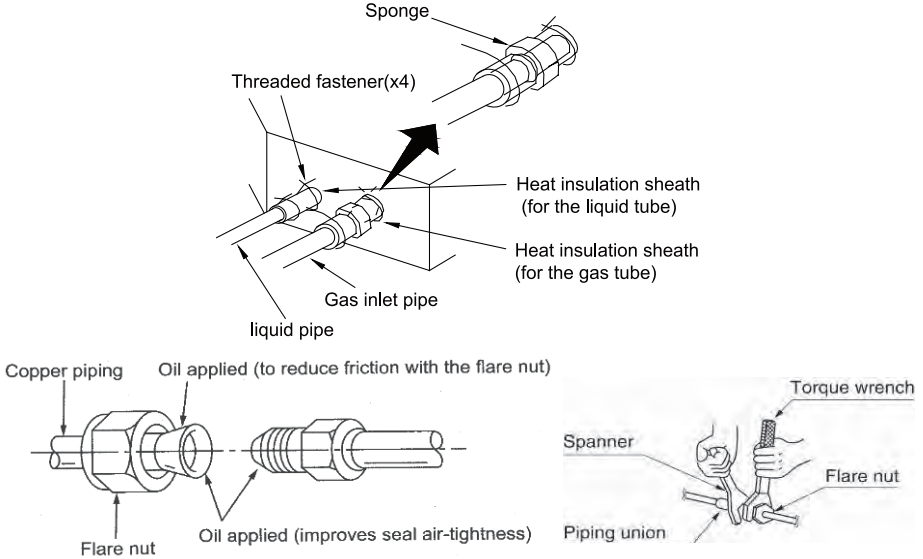
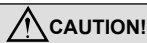

Fig.12

Table 6 Flare nut tightening torque

Pipe Diameter(inch)	Tightening Torque(ft-lb)
1/4	11-22
3/8	25-29
5/8	44-47
1/2	33-36
3/4	51-55
7/8	59-62



Be sure to connect the gas pipe after connecting the liquid pipe completely.

5.2.4 Connecting the Pipe at the Outdoor Side Unit

Tighten the flare nut of the connection pipe at the outdoor unit valve connector. The tightening method is the same as that as at the indoor side.

5.2.5 Checking the Pipe Connections for Gas Leaking

For both indoor and outdoor unit side, check the joints for gas leaking by the use of a gas leakage detector without fail when the pipes are connected.

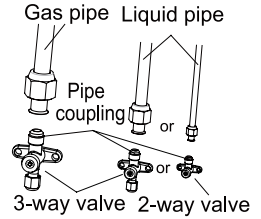

Fig.13

5.2.6 Heat Insulation on the Pipe Joints (Indoor Side Only)

Stick coupler heat insulation (large and small) to the place where connecting pipes.

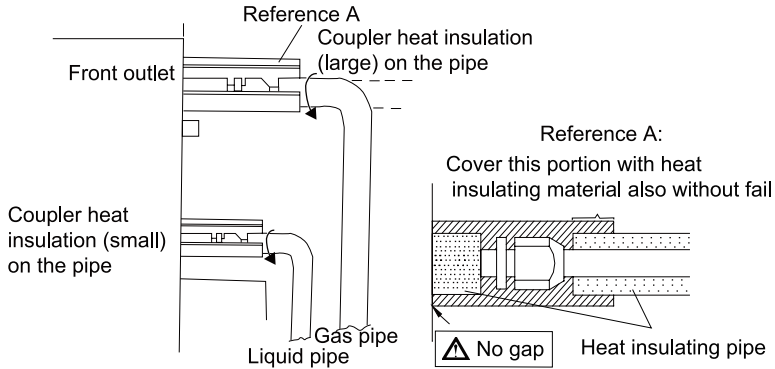

Fig.14

5.2.7 Liquid Pipe and Drain Pipe

If the outdoor unit is installed lower than the indoor unit (See Fig.15)

- (1). A drain pipe should be above ground and the end of the pipe does not dip into water. All pipes must be restrained to the wall by saddles.
- (2). Taping pipes must be done from bottom to top.
- (3). All pipes are bound together by tape and restrained to wall by saddles.

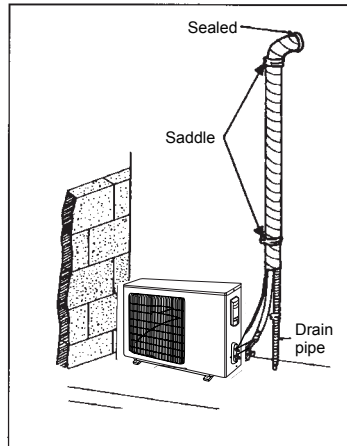

Fig.15

If the outdoor unit is installed higher than the indoor unit (See Fig.16)

- (1). Taping should be done from lower to the upper part.
- (2). All pipes are bound and taped together and also should be trapped to prevent water from returning to the room.
- (3). Restraint all pipes to the wall with saddles.

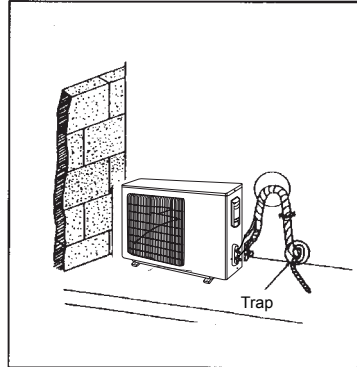

Fig.16

5.3 Vacuum and Gas Leakage Inspection

⚠ CAUTION!

Do not purge the air with refrigerants but use a vacuum pump to vacuum the installation! There is no extra refrigerant in the outdoor unit for air purging!

5.3.1 Vacuum

- (1). Remove the caps of the liquid valve, gas valve and also the service port.
- (2). Connect the hose at the low pressure side of the manifold valve assembly to the service port of the unit's gas valve, and meanwhile the gas and liquid valves should be kept closed in case of refrigerant leak.
- (3). Connect the hose used for evacuation to the vacuum pump.
- (4). Open the switch at the lower pressure side of the manifold valve assembly and start the vacuum pump. Meanwhile, the switch at the high pressure side of the manifold valve assembly should be kept closed, otherwise evacuation would fail.
- (5). The evacuation duration depends on the unit's capacity, generally, 40 minutes for the 30K/36K units. And verify if the pressure gauge at the low pressure side of the manifold valve assembly reads -0.1MPa (-750mmHg), if not, it indicates there is leak somewhere. Then, close the switch fully and then stop the vacuum pump.
- (6). Wait for some time to see if the system pressure can remain unchanged, 10 minutes for the 30K/36K units. During this time, the reading of the pressure gauge at the low pressure side can not be larger than 0.005MPa (37.5mmHg).

5.4 Installation of the Drain Pipe

- (1). It is not allowed to connect the condensate drain pipe into waste pipe or other pipelines which are likely to produce corrosive or peculiar smell to prevent the smell from entering indoors or corrupt the unit.
- (2). It is not allowed to connect the condensate drain pipe into rain pipe to prevent rain water from pouring in and cause property loss or personal injury.
- (3). Condensate drain pipe should be connected into special drain system for air conditioner.

5.4.1 Installation of Drain Pipe

- (1). Keep piping as short as possible and slope it downwards at a gradient of at least 1/100 so that air may not remain trapped inside the pipe.
- (2). Keep pipe size equal to or greater than that of the connecting pipe.
- (3). Install the drain piping as shown and take measures against condensation. Improperly rigged piping could lead to leaks and eventually wet furniture and belongings.

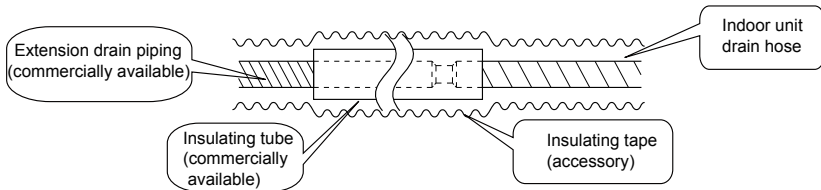
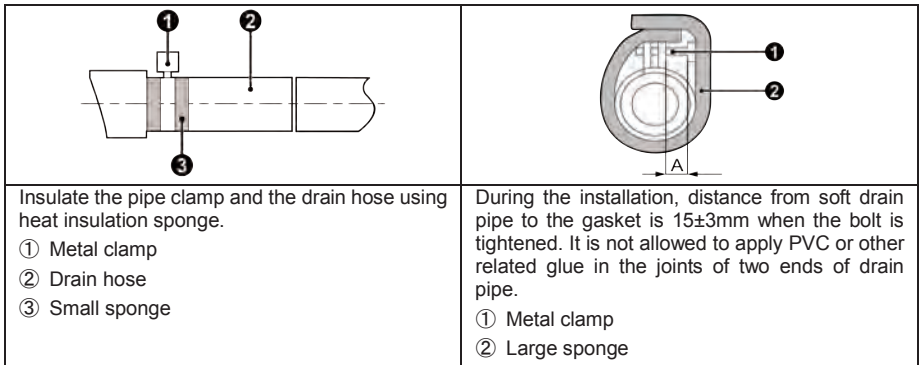

Fig.18

5.4.2 Installing the Drain Pipe

- (1). Insert the drain pipe to the drain outlet of the unit and then tighten the clamp securely with tape.
- (2). Connect the extension drain pipe to the drain pipe and then tighten the clamp with tape.



Indoor Unit	A
30K、36K	$\leq 5/8$ inch

- (3). When unifying multiple drain pipes, install the pipes as Fig.19. Select converging drain pipes whose gauge is suitable for the operating capacity of the unit.(take the cassette type unit for example)

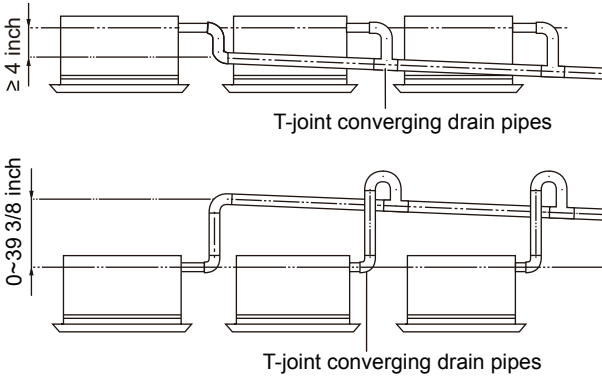

Fig.19

- (4). When the drain hose cannot keep a sufficient gradient, it is necessary to fit a riser pipe (field supplied) to it.
- (5). If the air flow of indoor unit is high, this might cause negative pressure and result in return suction of outdoor air. Therefore, U-type water trap shall be designed on the drainage side of each indoor unit.(Fig.20)
- (6). Install one water trap for each unit.
- (7). Installation of water trap shall consider easy cleaning in the future.

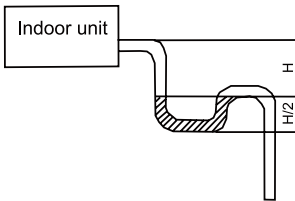

Fig.20

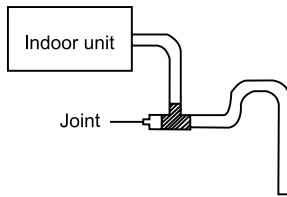

Fig.21

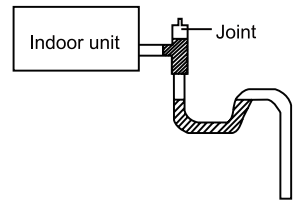
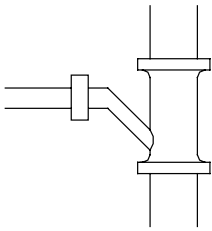

Fig.22

- (8). Connection of drainage branch pipe to the standpipe or horizontal pipe of drainage main pipe

The horizontal pipe cannot be connected to the vertical pipe at a same height. It can be connected in a manner as shown below:

- No.1: Attach the 3-way connection of the drainage pipe joint as shown in Fig.23.
- No.2: Attach the drain elbow as shown in Fig.24.
- No.3: Attach the horizontal pipe as shown in Fig.25.



3-way connection of drainage pipe joint

Fig.23

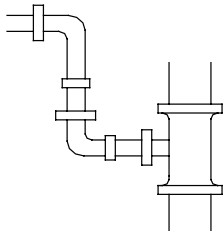

Connection of drain elbow

Fig.24

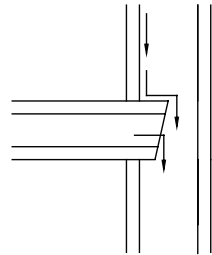

Connection of horizontal pipe

Fig.25

5.4.3 Precautions When Doing Riser Piping Work

(1). Make sure that heat insulation work is executed on the following 2 spots to prevent any possible water leakage due to dew condensation.

- 1). Connect the drain hose to the drain lift pipe, and insulate them.
- 2). Connect the drain hose to the drain outlet on the indoor unit, and tighten it with the clamp.

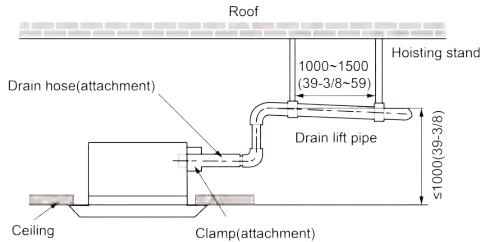

Unit: mm(inch)

Fig.26

(4). Secure a downward gradient of 1/100 or more for the drain pipe. To accomplish this, mount supporting brackets at an interval of 39"to59"

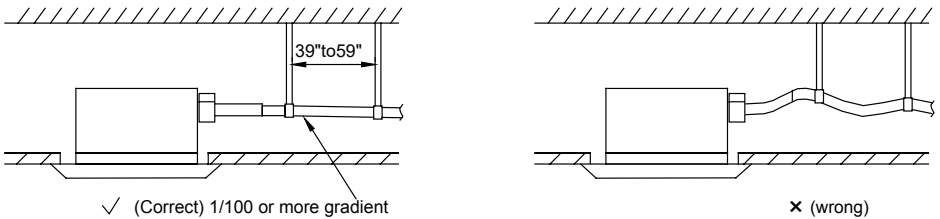

Fig.27

(5). The incline of attached drain hose should be 75 mm or less so that the drain outlet does not have to withstand additional force.

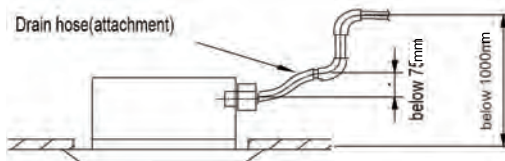
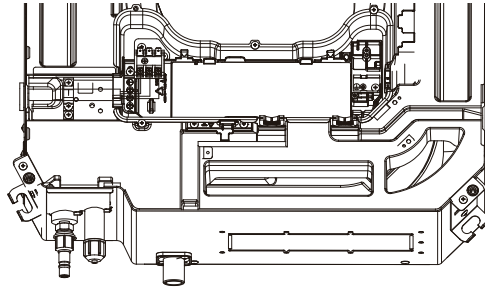

Fig.28

5.4.4 Check Drainage

After the pipeline work is finished, check whether the drainage can go smoothly.

- (1) Add slowly about 1L of water into the water tray. After the electric circuit is completed, check the drainage condition during refrigerating operation.



Single-phase units

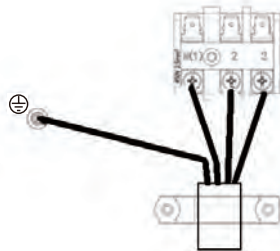
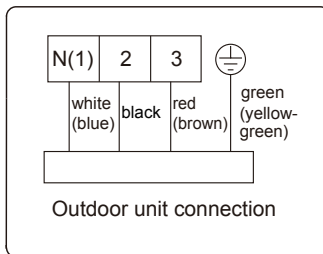

5.5 Installing the Front Panel

As shown below, take off the 4 corner covers from the front panel and loose the hexagon screw bolts on the 4 fasteners to the maximum. The position marked with “PIPING SIDE” on the front panel will direct right at the pipe mouth of the indoor unit.

- (1) Temporarily hang the 4 fasteners on the corresponding hooks of the main body of the indoor unit (Do not let the conducting wires get involved into the sealing material).
- (2) Screw in the hexagon screws beneath the 4 fasteners by about 15mm (Front panel will rise).
- (3) As shown below, turn the front panel according to the arrow direction so that the front panel can be well connected with the ceiling.

- (4) Screw up the screws until the thickness of the sealing material between the front panel and the ceiling is 5-8mm.

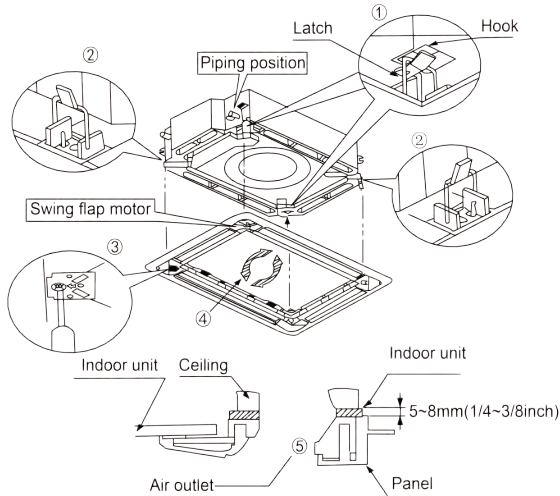

- (5) Securing the grille with 2 screws as shown in the picture.

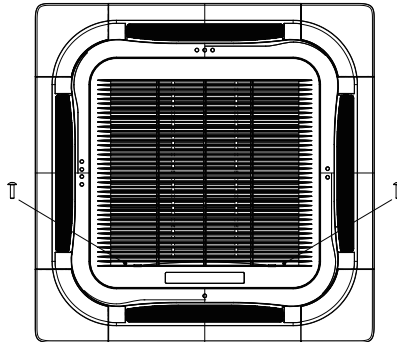

NOTES:

- (1) Improper screw looseness will lead to the following problem.

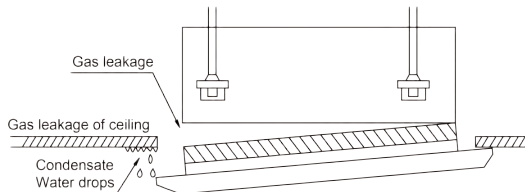

- (2) After the screws are tightened, if there is still a gap between the ceiling and the decorative front panel, adjust the height of the unit again (as shown below).

DC Inverter Free match Series Cassette Type Unit

If the lifting level of indoor unit and the drain pipeline won't be affected, it's fine to adjust the height of indoor unit through the holes on the corners of the front panel.

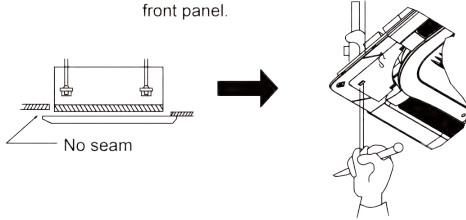

- (3) After installing the front panel, make sure there's no gap between the unit and the front panel.
- (4) Circuit of the decorative front panel.
- (5) Connect the front panel to the main body through the corresponding slots. Match the slots according to their different size.

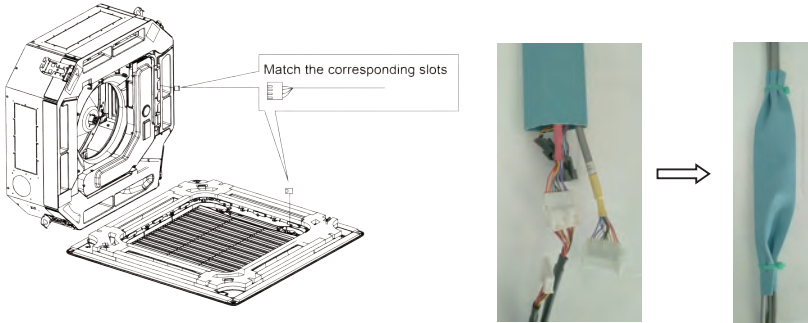

WARNING!

After installing the panel, the insulated protective cover with the thickness of 1mm shall be used to wrap the wiring terminal, Tighten the insulated glue cover on both sides with bonding tie to fix it.

5.6 Electrical Wiring

5.6.1 Wiring Precautions



WARNING!

- ① . Before obtaining access to terminals, all supply circuits must be disconnected.
- ② . The rated voltage of the unit is as shown as Table 4
- ③ . Always use a special branch circuit and install a special receptacle to supply power to the air conditioner.
- ④ . The special branch circuit breaker is installed in the permanent wiring. Always use a circuit that can trip all the poles of the wiring and has an isolation distance of at least 3mm between the contacts of each pole.
- ⑤ . Perform wiring work in accordance with standards so that the air conditioner can be operated safely and positively.
- ⑥ . Install a leakage special branch circuit breaker in accordance with the related laws and regulations and electric company standards.

CAUTION!

- ① . The power source capacity must be the sum of the air conditioner current and the current of other electrical appliances. When the current contracted capacity is insufficient, change the contracted capacity.
- ② . When the voltage is low and the air conditioner is difficult to start, contact the power company to raise the voltage.

5.6.2 Electrical Wiring

(1). For solid core wiring (Fig.29)

- 1). Cut the wire end with a wire cutter or wire-cutting pliers, then strip the insulation about 25 mm (15/16") .
- 2). Using a screwdriver, remove the terminal screw(s) on the terminal board.
- 3). Using pliers, bend the solid wire to form a loop suitable for the terminal screw.
- 4). Shape the loop wire properly, place it on the terminal board and tighten securely with the terminal screw using a screwdriver.

(2). For strand wiring (Fig.29)

- 1). Cut the wire end with a wire cutter or wire-cutting pliers, then strip the insulation about 10 mm (3/8") .
- 2). Using a screwdriver, remove the terminal screw (s) on the terminal board.
- 3). Using a round terminal fastener or pliers, securely clamp a round terminal to each stripped wire end.
- 4). Position the round terminal wire, and replace and tighten the terminal screw with a screwdriver.(Fig.30)

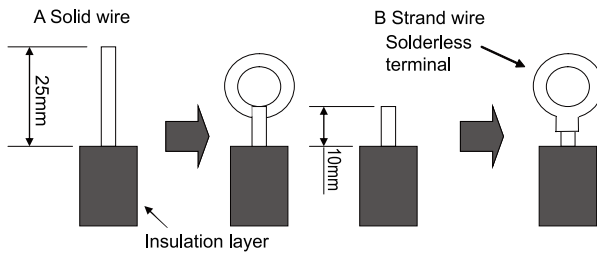

Fig.29

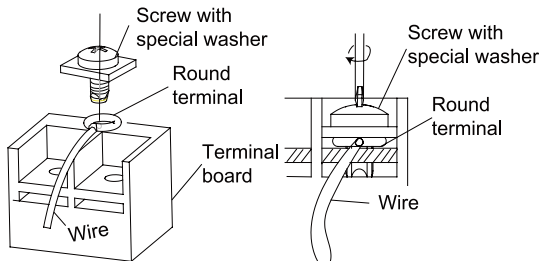

Fig.30

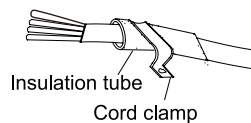

Fig.31

(3). How to fix connection cord and power cord by cord clamp

After passing the connection cord fasten it with the cord clamp.(Fig.31)



- | |
|--|
| ① . Before starting work, check that power is not being supplied to the indoor unit and outdoor unit. |
| ② . Match the terminal block numbers and connection cord colors with those of the indoor unit side. |
| ③ . Erroneous wiring may cause burning of the electric parts. |
| ④ . Connect the connection cords firmly to the terminal block. Imperfect installation may cause a fire. |
| ⑤ . Always fasten the outside covering of the connection cord with cord clamps. (If the insulator is not clamped, electric leakage may occur.) |
| ⑥ . Always connect the ground wire. |

(4). Electric wiring of indoor unit side

Take off the electric box cover from the sub-assembly of electric box. Then connect the wires. Connect the connection wires of indoor unit according to the corresponding marks.

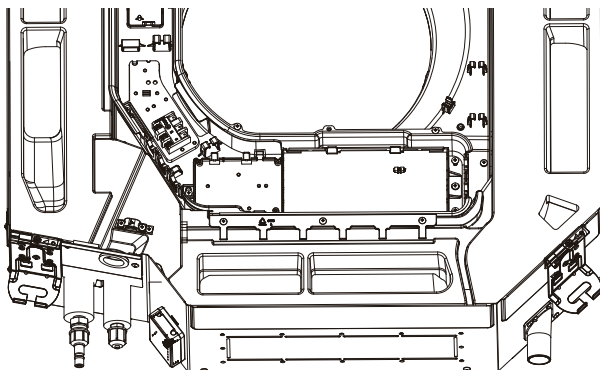
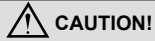

Fig.32



- | |
|---|
| ① . Tighten the power cord respectively on the terminal boards with screws. Faulty connection may cause a fire. |
| ② . If the power supply are wired incorrectly, the air conditioner may be damaged. |
| ③ . Connect the indoor unit connection cord properly based on the corresponding marks as shown in Fig.32. |
| ④ . Ground both the indoor and outdoor units by attaching a ground wire. |
| ⑤ . Unit shall be grounded in compliance with the applicable local and national codes. |

6 Installation of Controller

Refer to the Installation Manual of the controller for more details.

7 Test Running

7.1 Trial Operation and Testing

- (1). The meaning of error codes as shown below:

Table 8

Number	Error code	Error
1	E1	Compressor high pressure protection
2	E2	Indoor anti-freeze protection
3	E3	Compressor low pressure protection, refrigerant lack protection and refrigerant collecting mode
4	E4	Compressor high discharge temperature protection
5	E5	AC over-current protection
6	E6	Communication error
7	E7	Mode conflict
8	E8	Anti-high temperature protection
9	E9	Full water protection
10	F1	Indoor ambient temperature sensor is open/short circuited
11	F2	Indoor evaporator temperature sensor is open/short circuited
12	F3	Outdoor ambient temperature sensor is open/short circuited
13	F4	Outdoor condenser temperature sensor is open/short circuited
14	F5	Outdoor discharge temperature sensor is open/short circuited
15	C5	Jumper cap malfunction protection
16	EE	Loading EEPROM malfunction
17	EA	Refrigerant leakage alarm

Note: If there're other error codes, please contact qualified professionals for service.

When the unit is connected with the wired controller, the error code will be simultaneously shown on it.

(2). Instructions to the Error Indicating Lamps on the Panel of the Cassette Type Unit.

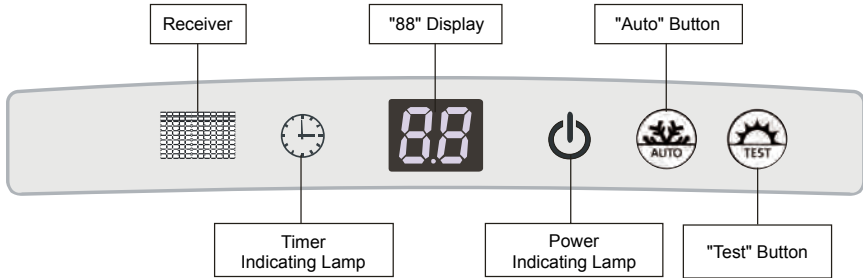

Fig.33

◆ Heating Indicating Lamp:

When this indicator is on, it indicates the heating mode is turned on.

◆ Cooling Indicating Lamp:

When this indicator is on, it indicates the cooling mode is turned on.

◆ Drying Indicating Lamp

When this indicator is on, it indicates the dry mode is turned on.

◆ Power and ON/OFF Indicating Lamp:

It goes red when the unit is powered on while it goes white when the unit is started.

◆ Timer Indicating Lamp:

Timer indicator on indoor unit will be on when timer ON is set under off status and timer OFF is set under on status.

◆ "88" Display:

When there is no error, the dual-8 nixie tube display the set temperature. After receiving the command of displaying indoor ambient temperature from the remote controller, the dual-8 nixie tube displays indoor temperature for 3s and then resume to display the set temperature. If there is error, error code will be displayed. If there's multiple error, error codes will be displayed in turn.

"Auto" button: It's used for turning on or turning off the unit. When use this button to turn in the unit, the unit is under auto mode.

"Test" button: It's only used for the test units. This button is only valid within 3mins after the unit is energized.

NOTE:

- (1) If the light of indoor unit is turned off, when operating the remote controller to send command, the display will be on for 3s and then off.
- (2) When the wired controller is connected, the indoor unit display is invalid and the unit won't receive the remote control command.

8 Troubleshooting and Maintenance

8.1 Troubleshooting

If your air-conditioning unit suffers from abnormal operation or failure, please first check the following points before repair:

Table 10

Failure	Possible Reasons
The unit cannot be started.	① . The power supply is not connected. ② . Electrical leakage of air-conditioning unit causes tripping of the leakage switch. ③ . The operating keys are locked. ④ . The control loop has failure.
The unit operates for a while and then stops.	① . There is obstacle in front of the condenser. ② . The control loop is abnormal. ③ . Cooling operation is selected when the outdoor ambient temperature is above 48°C.
Poor cooling effect.	① . The air filter is dirty or blocked. ② . There is heat source or too many people inside the room. ③ . The door or window is open. ④ . There is obstacle at the air intake or outlet. ⑤ . The set temperature is too high. ⑥ . There is refrigerant leakage. ⑦ . The performance of room temperature sensor becomes worse
Poor heating effect	① . The air filter is dirty or blocked. ② . The door or window is not firmly closed. ③ . The set room temperature is too low. ④ . There is refrigerant leakage. ⑤ . The outdoor ambient temperature is lower than -5°C. ⑥ . Control loop is abnormal.

Note: After carrying out the check of the above items and taking relevant measures to solve the problems but the air-conditioning unit still does not function well, please stop the operation of the unit immediately and contact the local service agency designated. Only ask professional serviceman to check and repair the unit.

9 SPECIALIST'S MANUAL

Aptitude requirement for maintenance man(repairs should be done only be specialists).

- a. Any person who is involved with working on or breaking into a refrigerant circuit should hold a current valid certificate from an industry-accredited assessment authority, which authorises their competence to handle refrigerants safely in accordance with an industry recognised assessment specification.
- b. Servicing shall only be performed as recommended by the equipment manufacturer. Maintenance and repair requiring the assistance of other skilled personnel shall be carried out under the supervision of the person competent in the use of flammable refrigerants.

That pipe-work including piping material, pipe routing, and installation shall include protection from physical damage in operation and service, and be in compliance with national and local codes and standards, such as ASHRAE 15, ASHRAE 15.2, IAPMO Uniform Mechanical Code, ICC International Mechanical Code, or CSA B52. All field joints shall be accessible for inspection prior to being covered or enclosed.

- **Checks to the area**
Prior to beginning work on systems containing flammable refrigerants, safety checks are necessary to ensure that the risk of ignition is minimised. For repair to the refrigerating system, the following precautions shall be complied with prior to conducting work on the system.
- **Work procedure**
Work shall be undertaken under a controlled procedure so as to minimise the risk of a flammable gas or vapour being present while the work is being performed.
- **General work area**
All maintenance staff and others working in the local area shall be instructed on the nature of work being carried out. Work in confined spaces shall be avoided.
- **Checking for presence of refrigerant**
The area shall be checked with an appropriate refrigerant detector prior to and during work, to ensure the technician is aware of potentially toxic or flammable atmospheres. Ensure that the leak detection equipment being used is suitable for use with all applicable refrigerants, i.e. non-sparking adequately sealed or intrinsically safe.
- **Presence of fire extinguisher**

If any hot work is to be conducted on the refrigerating equipment or any associated parts, appropriate fire extinguishing equipment shall be available to hand. Have a dry powder or CO2 fire extinguisher adjacent to the charging area.

- **No ignition sources**
No person carrying out work in relation to a refrigerating system which involves exposing any pipe work shall use any sources of ignition in such a manner that it may lead to the risk of fire or explosion. All possible ignition sources, including cigarette smoking, should be kept sufficiently far away from the site of installation, repairing, removing and disposal, during which refrigerant can possibly be released to the surrounding space. Prior to work taking place, the area around the equipment is to be surveyed to make sure that there are no flammable hazards or ignition risks. "No Smoking" signs shall be displayed.
- **Ventilated area**
Ensure that the area is in the open or that it is adequately ventilated before breaking into the system or conducting any hot work. A degree of ventilation shall continue during the period that the work is carried out. The ventilation should safely disperse any released refrigerant and preferably expel it externally into the atmosphere.
- **Checks to the refrigerating equipment**
Where electrical components are being changed, they shall be fit for the purpose and to the correct specification. At all times the manufacturer's maintenance and service guidelines shall be followed. If in doubt, consult the manufacturer's technical department for assistance.
The following checks shall be applied to installations using flammable refrigerants:
 - the actual refrigerant charge is in accordance with the room size within which the refrigerant containing parts are installed;
 - the ventilation machinery and outlets are operating adequately and are not obstructed;
 - if an indirect refrigerating circuit is being used, the secondary circuit shall be checked for the presence of refrigerant;
 - marking to the equipment continues to be visible and legible. Markings and signs that are illegible shall be corrected;
 - refrigerating pipe or components are installed in a position where they are unlikely to be exposed to any substance which may corrode refrigerant containing components, unless the components are constructed of materials which are inherently

resistant to being corroded or are suitably protected against being so corroded.

- **Checks to electrical devices**

Repair and maintenance to electrical components shall include initial safety checks and component inspection procedures. If a fault exists that could compromise safety, then no electrical supply shall be connected to the circuit until it is satisfactorily dealt with. If the fault cannot be corrected immediately but it is necessary to continue operation, an adequate temporary solution shall be used. This shall be reported to the owner of the equipment so all parties are advised.

Initial safety checks shall include:

- that capacitors are discharged: this shall be done in a safe manner to avoid possibility of sparking;
- that no live electrical components and wiring are exposed while charging, recovering or purging the system;
- that there is continuity of earth bonding.

- **Repairs to sealed components**

Sealed electrical components shall be replaced.

- **Repair to intrinsically safe components**

Intrinsically safe components must be replaced.

- **Cabling**

Check that cabling will not be subject to wear, corrosion, excessive pressure, vibration, sharp edges or any other adverse environmental effects. The check shall also take into account the effects of aging or continual vibration from sources such as compressors or fans.

- **Detection of flammable refrigerants**

Under no circumstances shall potential sources of ignition be used in the searching for or detection of refrigerant leaks. A halide torch (or any other detector using a naked flame) shall not be used.

The following leak detection methods are deemed acceptable for all refrigerant systems.

Electronic leak detectors may be used to detect refrigerant leaks but, in the case of flammable refrigerants, the sensitivity may not be adequate, or may need re-calibration. (Detection equipment shall be calibrated in a refrigerant-free area.) Ensure that the detector is not a potential source of ignition and is suitable for the refrigerant used. Leak detection equipment shall be set at a percentage of the LFL of the refrigerant and shall be calibrated to the refrigerant employed, and the appropriate percentage of gas (25% maximum) is confirmed.

Leak detection fluids are also suitable for use with

most refrigerants but the use of detergents containing chlorine shall be avoided as the chlorine may react with the refrigerant and corrode the copper pipe-work.

NOTE: Examples of leak detection fluids are

- bubble method,
- fluorescent method agents.

If a leak is suspected, all naked flames shall be removed/extinguished.

If a leakage of refrigerant is found which requires brazing, all of the refrigerant shall be recovered from the system, or isolated (by means of shut off valves) in a part of the system remote from the leak. Removal of refrigerant shall be according to clause Removal and evacuation.

- **Removal and evacuation**

When breaking into the refrigerant circuit to make repairs – or for any other purpose –conventional procedures shall be used. However, for flammable refrigerants it is important that best practice be followed, since flammability is a consideration. The following procedure shall be adhered to:

- safely remove refrigerant following local and national regulations;
 - evacuate;
 - purge the circuit with inert gas (optional for A2L);
 - evacuate (optional for A2L);
 - continuously flush or purge with inert gas when using flame to open circuit; and
 - open the circuit.

The refrigerant charge shall be recovered into the correct recovery cylinders if venting is not allowed by local and national codes. For appliances containing flammable refrigerants, the system shall be purged with oxygen-free nitrogen to render the appliance safe for flammable refrigerants. This process might need to be repeated several times. Compressed air or oxygen shall not be used for purging refrigerant systems.

For appliances containing flammable refrigerants, refrigerants purging shall be achieved by breaking the vacuum in the system with oxygen-free nitrogen and continuing to fill until the working pressure is achieved, then venting to atmosphere, and finally pulling down to a vacuum (optional for A2L). This process shall be repeated until no refrigerant is within the system (optional for A2L). When the final oxygen-free nitrogen charge is used, the system shall be vented down to atmospheric pressure to enable work to take place.

The outlet for the vacuum pump shall not be close to any potential ignition sources, and ventilation shall be available.

- **Charging procedures**

In addition to conventional charging procedures, the following requirements shall be followed.

- Ensure that contamination of different refrigerants does not occur when using charging equipment. Hoses or lines shall be as short as possible to minimise the amount of refrigerant contained in them.

- Cylinders shall be kept in an appropriate position according to the instructions.

- Ensure that the refrigerating system is earthed prior to charging the system with refrigerant.

- Label the system when charging is complete (if not already).

- Extreme care shall be taken not to overfill the refrigerating system.

Prior to recharging the system, it shall be pressure-tested with the appropriate purging gas. The system shall be leak-tested on completion of charging but prior to commissioning. A follow up leak test shall be carried out prior to leaving the site.

- **Decommissioning**

Before carrying out this procedure, it is essential that the technician is completely familiar with the equipment and all its detail. It is recommended good practice that all refrigerants are recovered safely. Prior to the task being carried out, an oil and refrigerant sample shall be taken in case analysis is required prior to re-use of recovered refrigerant. It is essential that electrical power is available before the task is commenced.

- a) Become familiar with the equipment and its operation.

- b) Isolate system electrically.

- c) Before attempting the procedure, ensure that:

- mechanical handling equipment is available, if required, for handling refrigerant cylinders;
- all personal protective equipment is available and being used correctly;
- the recovery process is supervised at all times by a competent person;
- recovery equipment and cylinders conform to the appropriate standards.

- d) Pump down refrigerant system, if possible.

- e) If a vacuum is not possible, make a manifold so that refrigerant can be removed from various parts of the system.

- f) Make sure that cylinder is situated on the scales before recovery takes place.

- g) Start the recovery machine and operate in accordance with instructions.

- h) Do not overfill cylinders. (No more than 80% volume liquid charge).

- i) Do not exceed the maximum working pressure of the cylinder, even temporarily.

- j) When the cylinders have been filled correctly and the process completed, make sure that the cylinders and the equipment are removed from site promptly and all isolation valves on the equipment are closed off.

- k) Recovered refrigerant shall not be charged into another refrigerating system unless it has been cleaned and checked.

- **Labelling**

Equipment shall be labelled stating that it has been de-commissioned and emptied of refrigerant. The label shall be dated and signed. For appliances containing flammable refrigerants, ensure that there are labels on the equipment stating the equipment contains flammable refrigerant.

- **Recovery**

When removing refrigerant from a system, either for servicing or decommissioning, it is recommended good practice that all refrigerants are removed safely.

When transferring refrigerant into cylinders, ensure that only appropriate refrigerant recovery cylinders are employed. Ensure that the correct number of cylinders for holding the total system charge are available. All cylinders to be used are designated for the recovered refrigerant and labelled for that refrigerant (i.e. special cylinders for the recovery of refrigerant). Cylinders shall be complete with pressure-relief valve and associated shut-off valves in good working order. Empty recovery cylinders are evacuated and, if possible, cooled before recovery occurs.

The recovery equipment shall be in good working order with a set of instructions concerning the equipment that is at hand and shall be suitable for the recovery of the flammable refrigerant. If in doubt, the manufacturer should be consulted. In addition, a set of calibrated weighing scales shall be available and in good working order. Hoses shall be complete with leak-free disconnect couplings and in good condition.

The recovered refrigerant shall be processed according to local legislation in the correct recovery cylinder, and the relevant waste transfer note arranged. Do not mix refrigerants in recovery units and especially not in cylinders.

If compressors or compressor oils are to be removed, ensure that they have been evacuated

to an acceptable level to make certain that flammable refrigerant does not remain within the lubricant. The compressor body shall not be heated by an open flame or other ignition sources to accelerate this process. When oil is drained from a system, it shall be carried out safely.

Transportation, marking and storage for units **Transport of equipment containing flammable refrigerants.**

Attention is drawn to the fact that additional transportation regulations may exist with respect to equipment containing flammable gas. The maximum number of pieces of equipment or the configuration of the equipment permitted to be transported together will be determined by the applicable transport regulations.

Marking of equipment using signs

Signs for similar appliances used in a work area are generally addressed by local regulations and give the minimum requirements for the provision of safety and/or health signs for a work location.

All required signs are to be maintained and employers should ensure that employees receive suitable and sufficient instruction and training on the meaning of appropriate safety signs and the actions that need to be taken in connection with these signs.

The effectiveness of signs should not be diminished by too many signs being placed together.

Any pictograms used should be as simple as possible and contain only essential details.

Disposal of equipment using flammable refrigerants

See national regulations.

Storage of equipment/appliances

The storage of the appliance should be in accordance with the applicable regulations or instructions, whichever is more stringent.

Avoid other heat sources or direct sun light.

Avoid a place where is possible for inflammable gas to leak out.

Storage of packed (unsold) equipment

Storage package protection should be constructed such a way that mechanical damage to the equipment inside the package will not cause a leak of the REFRIGERANT CHARGE.

The maximum number of pieces of equipment permitted to be stored together will be determined by local regulations.



GREE ELECTRIC APPLIANCES, INC. OF ZHUHAI

Add: West Jinji Rd, Qianshan, Zhuhai, Guangdong, China, 519070

Tel: (+86-756) 8522218

Fax: (+86-756) 8669426

E-mail: global@cn.gree.com

Web: www.gree.com



600005068543