

# OWNER'S MANUAL

---

## TTW Air Conditioner

### Models

26TTW09AC230V1A-T	26TTW09HC230V1A-T
26TTW12AC230V1A-T	26TTW12HC230V1A-T
26TTW09HP230V1A-T	26TTW12HP230V1A-T
26TTW09AC115V1A-T	26TTW12AC115V1A-T
26TTW09HP115V1A-T	26TTW07HP230V1A-T

Thank you for choosing our product.

For proper operation, please read and keep this manual carefully.

# Contents

SAFETY PRECAUTIONS .....	1
IMPORTANT NOTE TO THE OWNER .....	4
IMPORTANT NOTE TO THE SERVICER.....	4
TRANSPORTATION DAMAGE .....	4
UNPACKING THE UNIT.....	4
OPERATING INSTRUCTIONS .....	4
INSTALLATION INSTRUCTIONS .....	5
WIRING .....	8
AIR CONDITIONER FEATURES.....	9
AUXILIARY CONTROLS-DIP SWITCHES.....	12
AIR CONDITIONER FEATURES.....	13
ADDITIONAL THINGS YOU SHOULD KNOW.....	17
WARRANTY.....	18

This appliance is not intended for use by persons (including children) with reduced physical, sensory or mental capabilities, or lack of experience and knowledge, unless they have been given supervision or instruction concerning use of the appliance by a person responsible for their safety. Children should be supervised to ensure that they do not play with the appliance.

It is not allowed to be installed on an unstable or mobile base structure (such as a truck), or in a corrosive environment.



## WARNING

### HIGH VOLTAGE!

**Disconnect ALL power before servicing or installing. Multiple power sources may be present. Failure to do so may cause property damage, personal injury, or death.**



**RECOGNIZE THIS SYMBOL AS A SAFETY PRECAUTION.**

## ATTENTION INSTALLING PERSONNEL

As a professional installer you have an obligation to know the product better than the customer. This includes all safety precautions and related items.

Prior to actual installation, thoroughly familiarize yourself with this Instruction Manual. Pay special attention to all safety warnings. Often during installation or repair it is possible to place yourself in a position which is more hazardous than when the unit is in operation.

Instructions for installation and use of this product are provided by the manufacturer.

Remember, it is your responsibility to install the product safely and to know it well enough to be able to instruct a customer on its safe use.

Safety is a matter of common sense...a matter of thinking before acting. Most dealers have a list of specific good safety practices...follow them.

The precautions listed in this Installation Manual are intended as supplemental to existing practices. However, if there is a direct conflict between existing practices and the content of this manual, the precautions listed here take precedence.

# EXPLANATION OF SYMBOLS



Indicates a hazardous situation that, if not avoided, will result in death or serious injury.



Indicates a hazardous situation that, if not avoided, could result in death or serious injury.



Indicates a hazardous situation that, if not avoided, may result in minor or moderate injury.





Indicates important but not hazard-related information, used to indicate risk of property damage.





Indicates a hazard that would be assigned a signal word WARNING or CAUTION.

# Safety Precautions

















To prevent injury to the user or other people and property damage, the following instructions must be followed. Incorrect operation due to ignoring of instructions may cause harm or damage. The seriousness is classified by the following indications.

 <b>WARNING</b>	This symbol indicates the possibility of death or serious injury.
 <b>CAUTION</b>	This symbol indicates the possibility of injury or damage to property.

- Meaning of symbols used in this manual are as shown below.

	<b>NEVER DO THIS.</b>
	<b>ALWAYS DO THIS.</b>

## WARNING

- |  |  |  |
|--|--|--|
| <p> Plug in power plug properly</p> <ul style="list-style-type: none"> <li>● Otherwise, it may cause electric shock or fire due to excess heat generation.</li> </ul>                                 | <p> Do not operate or stop the unit by inserting or pulling out the power plug.</p> <ul style="list-style-type: none"> <li>● It may cause electric shock or fire due to heat generation.</li> </ul> | <p> Do not damage or use an unspecified power cord.</p> <ul style="list-style-type: none"> <li>● If the power cord is damaged, it must be replaced by the manufacturer or an authorized service center in order to avoid hazard.</li> </ul> |
| <p> Do not modify power cord length or share the outlet with other appliances.</p> <ul style="list-style-type: none"> <li>● It may cause electric shock or fire due to heat generation.</li> </ul>    | <p> Do not operate with wet hands or in damp environment.</p> <ul style="list-style-type: none"> <li>● It may cause electric shock.</li> </ul>  | <p> Do not direct airflow at room occupants only.</p> <ul style="list-style-type: none"> <li>● This could damage your health.</li> </ul>  |
| <p> Always ensure effective grounding.</p> <ul style="list-style-type: none"> <li>● Incorrect grounding may cause electric shock.</li> </ul>  | <p> Do not allow water to run into electric parts.</p> <ul style="list-style-type: none"> <li>● It may cause failure of machine or electric shock.</li> </ul>                                       | <p> Always install circuit breaker and a dedicated power circuit.</p> <ul style="list-style-type: none"> <li>● Incorrect installation may cause fire and electric shock.</li> </ul>   |
| <p> Unplug the unit if strange sounds, smell, or smoke comes from it.</p> <ul style="list-style-type: none"> <li>● It may cause fire and electric shock.</li> </ul>                                   | <p> Do not use the socket if it is loose or damaged.</p> <ul style="list-style-type: none"> <li>● It may cause fire and electric shock.</li> </ul>  | <p> Do not open the unit during operation.</p> <ul style="list-style-type: none"> <li>● It may cause electric shock.</li> </ul>   |
| <p> Keep firearms away.</p> <ul style="list-style-type: none"> <li>● It may cause fire.</li> </ul>  | <p> Do not use the power cord close to heating appliances.</p> <ul style="list-style-type: none"> <li>● It may cause fire and electric shock.</li> </ul>  | <p> Do not use the power cord near flammable gas or combustibles, such as gasoline, benzene, thinner, etc.</p> <ul style="list-style-type: none"> <li>● It may cause an explosion or fire.</li> </ul>                                       |
| <p> Ventilate room before operating air conditioner if there is a gas leakage from another appliance.</p> <ul style="list-style-type: none"> <li>● It may cause explosion, fire and burns.</li> </ul> | <p> Do not disassemble or modify unit.</p> <ul style="list-style-type: none"> <li>● It may cause failure and electric shock.</li> </ul>   |  |

# Safety Precautions



## CAUTION



When the air filter is to be removed, do not touch the metal parts of the unit.

- It may cause an injury.



Do not clean the air conditioner with water.

- Water may enter the unit and degrade the insulation. It may cause an electric shock.



Ventilate the room well when used together with a stove, etc.

- An oxygen shortage may occur.



When the unit is to be cleaned, switch off, and turn off the circuit breaker.

- Do not clean unit when power is on as it may cause fire and electric shock, it may cause an injury.



Do not put a pet or house plant where it will be exposed to direct air flow.

- This could injure the pet or plant.



Do not use for special purposes.

- Do not use this air conditioner to preserve precision devices, food, pets, plants, and art objects. It may cause deterioration of quality, etc.



Stop operation and close the window in storm or hurricane.

- Operation with windows opened may cause wetting of indoor and soaking of household furniture.



Hold the plug by the head of the power plug when taking it out.

- It may cause electric shock and damage.



Turn off the main power switch when not using the unit for a long time.

- It may cause failure of product or fire.



Do not place obstacles around air-inlets or inside of air-outlet.

- It may cause failure of appliance or accident.



Ensure that the installation bracket of the outdoor appliance is not damaged due to prolonged exposure.

- If bracket is damaged, there is concern of damage due to falling of unit.



Always insert the filters securely. Clean the filter once every two weeks.

- Operation without filters may cause failure.



Do not use strong detergent such as wax or thinner but use a soft cloth.

- Appearance may be deteriorated due to change of product color or scratching of its surface.



Do not place heavy object on the power cord and ensure that the power cord is not compressed.

- There is danger of fire or electric shock.



Do not drink water drained from air conditioner.

- It contains contaminants and could make you sick.



Use caution when unpacking and installing. Sharp edges could cause injury.



If water enters the unit, turn the unit off at the power outlet and switch off the circuit breaker. Isolate supply by taking the power plug out and contact a qualified service technician.

# Safety Precautions

**NOTICE** The power supply cord with this air conditioner contains a current detection device designed to reduce the risk of fire. Please refer to the section Operation of Current Device, for details. In the event that the power supply cord is damaged, it cannot be repaired-it must be replaced with a cord from the Product Manufacturer.

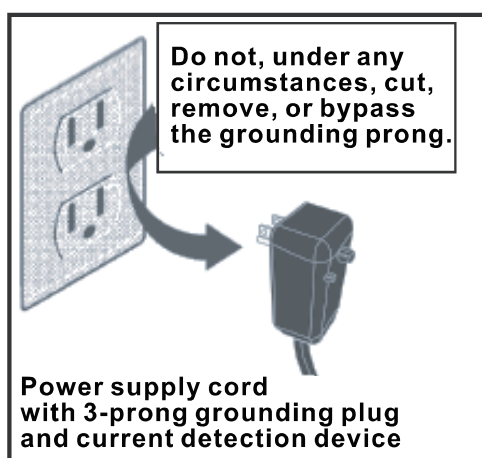

## **▲ WARNING For your safety**

- Do not store or use gasoline or other flammable vapors and liquids in the vicinity of this or any other appliance.
- Avoid fire hazard or electric shock. Do not use an extension cord or an adaptor plug. Do not remove any prong from the power cord.

## **▲ WARNING Electrical Information**

- Be sure the electrical service is adequate for the model you have chosen. This information can be found on the serial plate, which is located on the side of the cabinet and behind the grille.
  - Be sure the air conditioner is properly grounded. To minimize shock and fire hazards, proper grounding is important. The power cord is equipped with a three-prong grounding plug for protection against shock hazards.
  - Your air conditioner must be used in a properly grounded wall receptacle. If the wall receptacle you intend to use is not adequately grounded or protected by a time delay fuse or circuit breaker, have a qualified electrician install the proper receptacle.
  - Ensure the receptacle is accessible after the unit installation.
  - Do not run air conditioner without side protective cover in place. This could result in mechanical damage within the air conditioner.
- Do not use an extension cord or an adapter plug.**

## Operation of Current Device

The power supply cord contains a current device that senses damage to the power cord. To test your power supply cord do the following:

1. Plug in the Air Conditioner.
2. The power supply cord will have TWO buttons on the plug head. Press the TEST button, you will notice a click as the RESET button pops out.
3. Press the RESET button, again you will notice a click as the button engages.
4. The power supply cord is now supplying electricity to the unit. (On some products this it also indicated by a light on the plug head.)

### NOTES:

- Do not use this device to turn the unit on or off.
- Always make sure the RESET button is pushed in for correct operation.
- The power supply cord must be replaced if it fails reset when either the TEST button is pushed, or it cannot be reset. Please contact Customer Service.
- If power supply cord is damaged. It cannot be repaired . It MUST be replaced with a new cord – please contact Customer Service.

## IMPORTANT NOTE TO THE OWNER

This equipment is to be serviced by professionally trained personnel only. If this equipment is improperly installed, adjusted or altered by an unqualified person, a safety hazard may result.

## IMPORTANT NOTE TO THE SERVICER

Read this manual and familiarize yourself with the specific items which must be adhered to before attempting to service this unit. The precautions listed in this manual should not supersede existing practices but should be considered as supplemental information.

## TRANSPORTATION DAMAGE

All units are securely packed in shipping containers approved by the National Safe Transit Association. The carton should be checked upon arrival for external damage. If damage is found, immediately make a written request for inspection by the carrier's agent.

In the event of damage:

1. Note on the delivery receipt any visible damage to shipment or container.
2. Notify carrier promptly and request an inspection.
3. File the claim with the following supporting documents within the six month statute of limitations.
  - a. Original Bill of Lading, certified copy, or indemnity bond.
  - b. Original paid freight bill or indemnity.
  - c. Original invoice or certified copy, showing trade and other discounts or reductions.
  - d. Copy of the inspection report issued by carrier's representative at the time damage is reported to the carrier.

The carrier is responsible for making prompt inspection of damage and for a thorough investigation of each claim. The distributor or manufacturer will not accept claims from dealers for transportation damage.

## UNPACKING THE UNIT

1. Cut the carton banding and open the carton.
2. Remove the literature, hardware pack, upper styrofoam shipping blocks, and styrofoam corner posts.
3. Remove the front assembly.
4. Lift the unit from the remaining carton.
5. Dispose of the cardboard and styrofoam at an approved Recycle Center. Check all contents for damaged or missing parts. In case of concealed damage, notify the carrier as soon as possible—preferably within 5 days. Refer to step 3 of the Transportation Damage section if damage or missing parts are noted.

## OPERATING INSTRUCTIONS

Check the data specification plate and ensure the proper voltage and current rating for the type of power plug on the unit is available. **DO NOT REMOVE THE GROUNDING PRONG FROM THE POWER CORD** See Figure 1 for the types of acceptable plugs. Do not use an extension cord for the installation of this product. Refer to the data specification plate for electrical requirements.

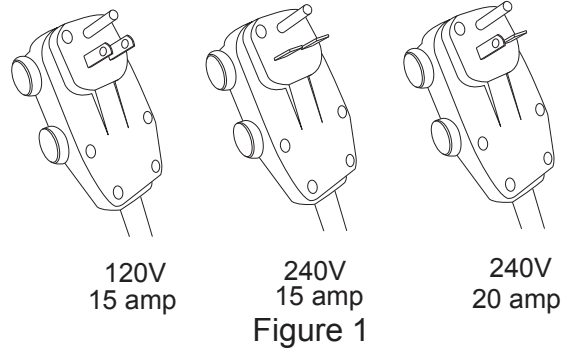

- LCDI or AFCI Power Cords - Underwrites Laboratories and the National Electric Code (NEC) now require power cords that sense current leakage and can open the electrical circuit to the unit on units rated at 250 volts or less. In the event that unit does not operate, check the reset button located on or near the head of the power cord as part of the normal troubleshooting procedure.

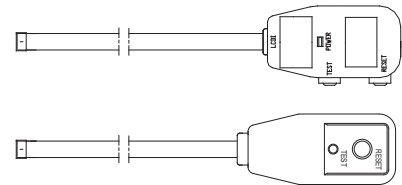

LCDI power Cord

**Note:** Plug may be different with the actual product. Please refer to actual product.

## VOLTAGE MEASUREMENTS

Before connecting the unit, measure the supply voltage. Voltage must fall within the voltage utilization range given in Table 1.

Operating Voltage		
Unit Voltage Rating	Voltage Utilization Range	
	Minimum	Maximum
230/208	187	253
115	103	126

Table 1  
Operating Voltage



## WARNING

To prevent electrical shock, property damage, personal injury, or death, do not remove grounding prong from plug. Follow all operating instructions.

## INSTALLATION INSTRUCTIONS

To ensure that the unit operates safely and efficiently, it must be installed, operated, and maintained according to these installation and operating instructions and all local codes and ordinances, or, in their absence, with the latest edition of the National Electrical Code. The proper installation of this unit is described in the following sections. Following the steps in the order presented should ensure proper installation.

### Sleeve installation

In order for condensate water to drain properly inside the unit, the sleeve must be installed properly:

- Level from right to left.
- A slight downward pitch from the indoor side to the outdoor side as shown in Figure 3.

Refer to the Installation Instructions supplied with the wall sleeve for a complete description of the installation procedure.

**NOTE:** Wall sleeve (PBWS01A) is not shipped with chassis and must be purchased separately.

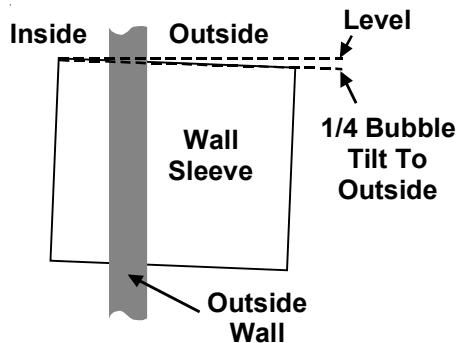

Figure 2

## CHASSIS INSTALLATION

1. Remove front grille. See Figure A.

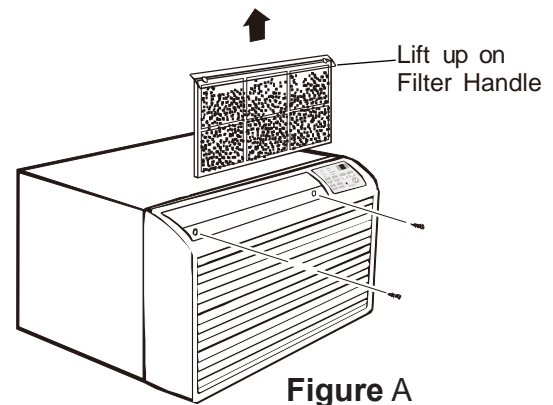
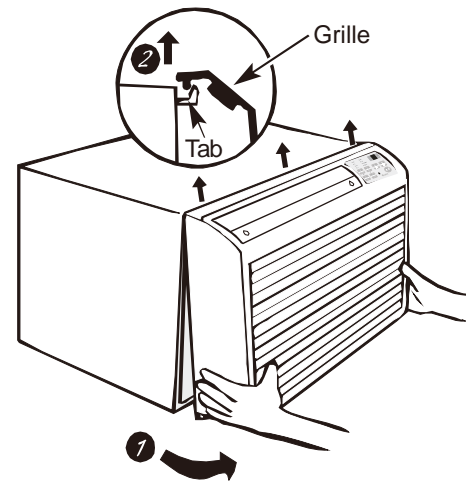

Figure A

The front grille can be removed for more thorough cleaning or to make the model and serial numbers accessible. To remove, pull the filter out and remove the two grille screws.



Pull the grille out from the bottom and lift up from the tabs on the top of the case.

2. Remove the grounding screw and wire next to the grounding symbol on right side of chassis control panel (Figure 3). Attach other end of ground wire to the hole in the bottom right side of the sleeve with #8 x 3/8" blunt point sheet metal screw. The hole on the sleeve is indicated by grounding symbol on the sleeve. Slide chassis part of the way into the sleeve and reattach the ground wire back to the hole on the right side on the control panel area next to the grounding symbol.



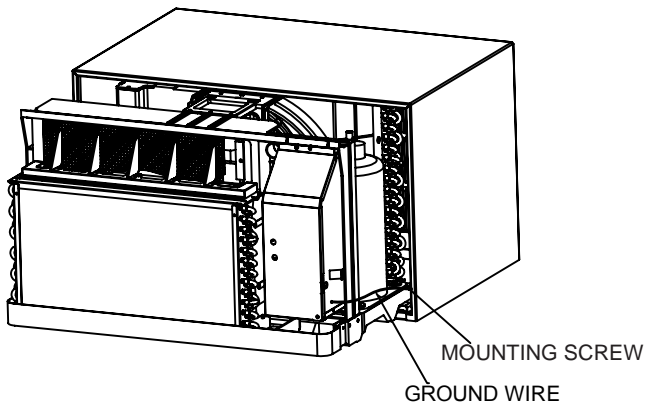

**Figure 3**

3. Remove shipping pads inside air conditioner next to compressor. (See Figure B.)

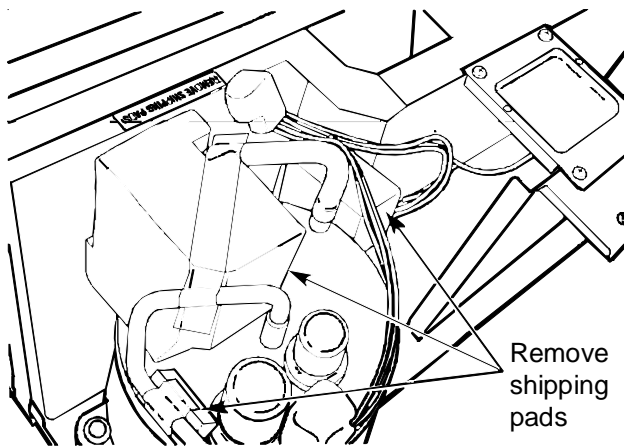

**Figure B**

4. Carefully slide the chassis into the sleeve. Ensure that the ground wire is not pinched or in the path of the condenser fan.

5. Loosen locking plate screw and rotate tab with tab behind wall case flange (See Figure C) then tighten locking plate screw.

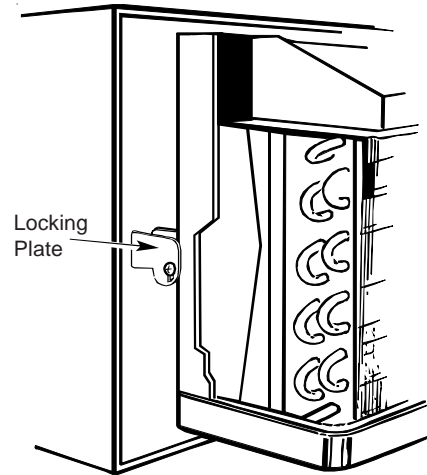

**Figure C**

6. If outlet is on the left side of the unit. route power cord as shown in Figure D.

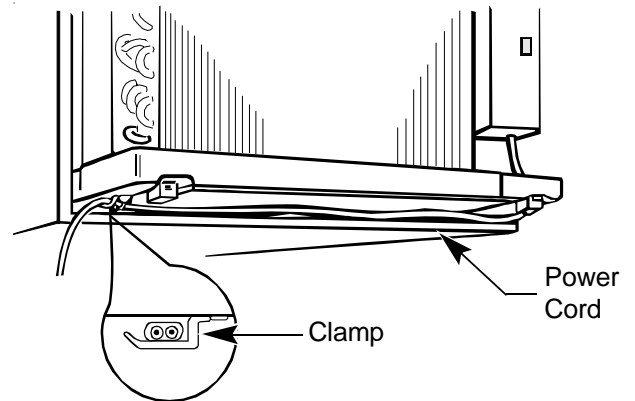

**Figure D**

To replace front grille:

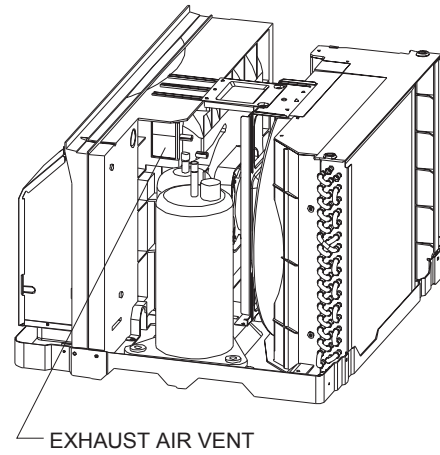
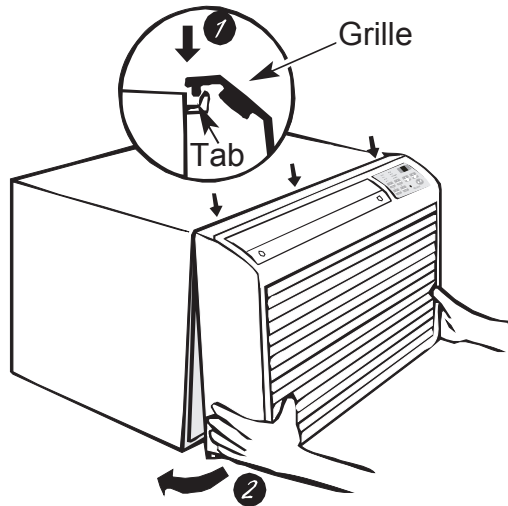

Figure 4

Hook the tabs on the front grille even with the tabs on the case and snap into place. Replace the screws and filter. Refer to Page 2, Figure A.

**AIR DIRECTION:**

Horizontal louvers on the front grille let you control the air direction up and down.

**VENT CONTROL AND AIR DIRECTION** (See Figure E)  
The vent control is located behind the front grille on the right side of the air discharge area. When set at CLOSE only the air inside the room will be circulated and conditioned. When set at OPEN, some inside air is exhausted outside.

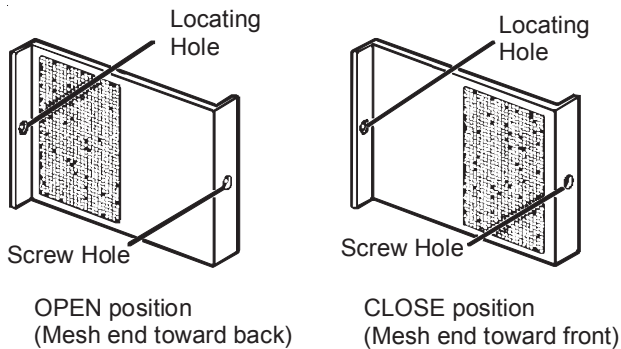
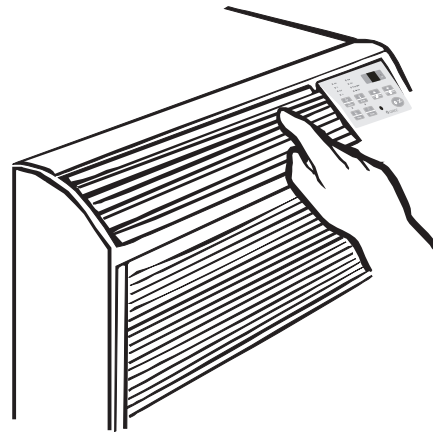

Figure E

To open or close the vent:

1. Remove the unit from the sleeve to access this vent door.
2. Remove the vent card screw.
3. Remove the vent card, turn it over and replace it by locating rear hole in card over locating pin inside air discharge and reattaching screw at front.

Remove the front grille to adjust the vertical louvers side-to-side to direct the air left or right.

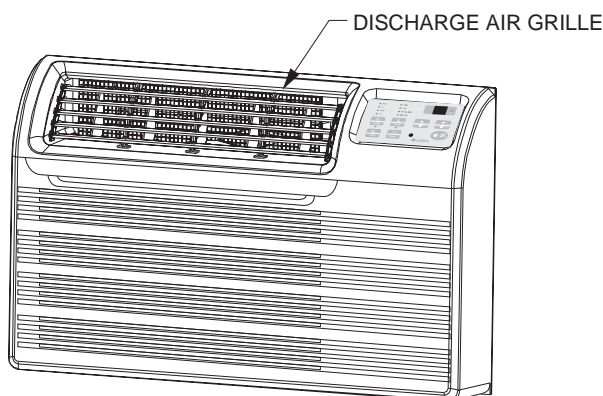
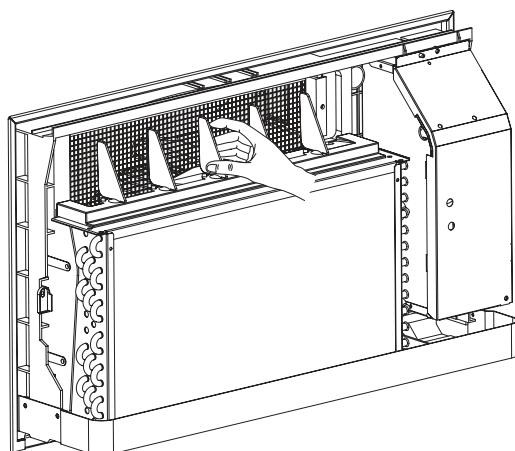

Figure 5

**IMPORTANT NOTES:**

1. The unit is equipped with a rubber-grommet-mounted compressor. These grommets are factory set and require no adjustment.
2. Obstruction to air flow must be checked and removed. Check the indoor and outdoor grilles for obstructions. The unit must be located where curtains, furniture, trees, or other objects do not block air flow to and from the unit. If air is obstructed and/or deflected back into the unit, the air conditioner's compressor may cycle on and off rapidly. This could cause damage to the compressor.

**WIRING**

Before wiring the unit, please review the following warnings and cautions.

**! WARNING**

To avoid the risk of electrical shock, personal injury or death, do not service this unit without first opening all disconnects and/or removing the unit cord set plug from the wall outlet.

**! WARNING**

To avoid the risk of electrical shock, personal injury, or property damage, do not use an extension cord with this unit.

**! WARNING**

To avoid the risk of fire, property damage, or personal injury, use only copper conductors.

**! WARNING**

To avoid the risk of personal injury, wiring to the unit must be properly polarized and grounded.

**! WARNING**

This air conditioner is not meant to provide unattended cooling or life support for persons or animals who are unable to react to the failure of this product.

The failure of an unattended air conditioner may result in extreme heat in the conditioned space causing overheating or death of persons or animals. Take proper precautions to avoid unattended operation.

# AIR CONDITIONER FEATURES

# ELECTRONIC CONTROL OPERATING INSTRUCTIONS

Before you begin, thoroughly familiarize yourself with the control panel and remote as shown below and all its functions. Then follow the symbol for the functions you desire. The unit can be controlled by the touch pad alone or with the remote.

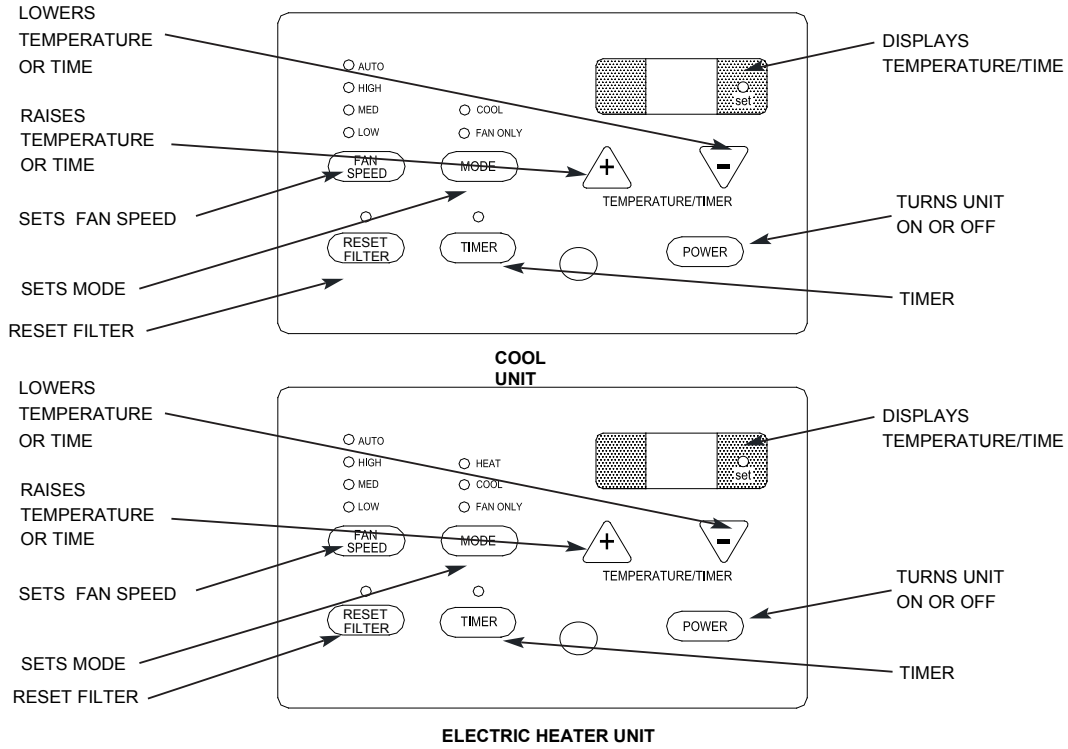

## Remote Control

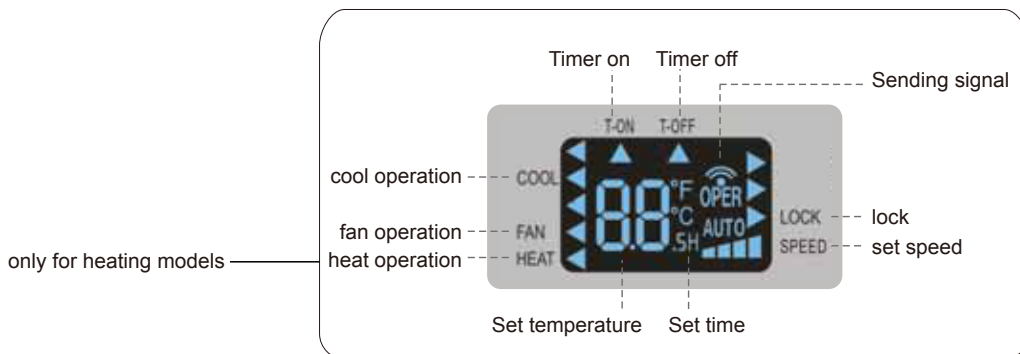
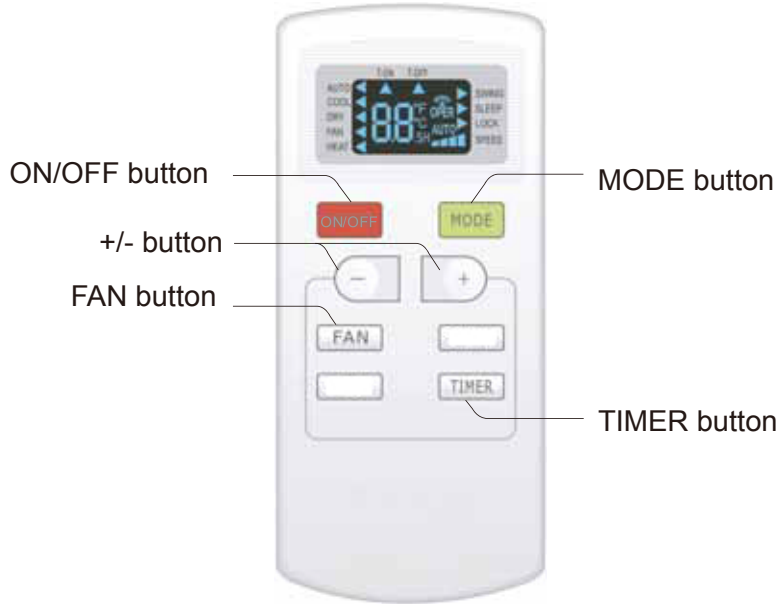

# AIR CONDITIONER FEATURES

## Notice:

- When power is connected (stand by condition), you can operate the air conditioner through the remote control.
- When unit is on, each time you press the button on the remote control, the sending signal icon “” on the display of remote control will blink once. If the air conditioner gives out a beep sound, it means the signal has been sent.
- When unit is off, set temperature will be displayed on the remote control. *If the light of indoor unit display is turned on, the corresponding icon will be displayed.* When the unit is on, it will display the icon of the on-going function.
- This is a general use remote control, it could be used for air conditioners with multifunction. For some function, which the model doesn't have, if press the corresponding button on the remote control that the unit will keep the original running status.

### 1 ON/OFF button

Press this button to turn unit on/off.

### 2 MODE button

Pressing this button once can select your required mode circularly as below (the corresponding icon “” will be lit up after the mode is selected):



*\*Only for models with heating function.*





- When selecting cool mode, the air conditioner will operate under cool mode. Then press + or - button to adjust set temperature. Press FAN button to adjust fan speed.
- When selecting fan mode, the air conditioner will operate in fan mode only. Then press the FAN button to adjust fan speed.
- When selecting heat mode, the air conditioner will operate under heat mode. Then press + or - button to adjust the set temperature. Press FAN button to adjust fan speed. *Cooling only units can't receive heating mode signal. If setting HEAT mode by the remote control, pressing the ON/OFF button can't turn on the air conditioner.*

**Note:** The unit can only receive the signal for cool/fan/heat and it has no action when receiving the signal of other mode.

### 3 + / - button

- Pressing “+” or “-” button once will increase or decrease set temperature by 1°F(°C). Hold “+” or “-” button for 2 seconds, set temperature on remote controller will change quickly. Release the button after your required set temperature is reached.
- When setting Timer On or Timer Off, press “+” or “-” button to adjust the time. *See TIMER Button for setting details.*

### 4 FAN button

Pressing this button can select fan speed circularly as: AUTO, SPEED 1 () , SPEED 2 () , SPEED 3 () , SPEED 4 () .



## Note:

- Under Auto speed, air conditioner will select proper fan speed automatically according to ambient temperature.

### 5 TIMER button

- When unit is on, press this button to set Timer Off. T-OFF and H icon will be blinking. Within 5 seconds, press “+” or “-” button to adjust the time for Timer Off. Pressing “+” or “-” button once will increase or decrease the time by 0.5h. Hold “+” or “-” button for 2 seconds, time will change quickly. Release the button after your required set time is reached. Then press TIMER button to confirm it. T-OFF and H icon will stop blinking.
- When unit is off, press this button to set Timer On. T-ON and H icon will be blinking. Within 5 seconds, press “+” or “-” button to adjust the time for Timer On. Pressing “+” or “-” button once will increase or decrease the time by 0.5h. Hold “+” or “-” button for 2 seconds, time will change quickly. Release the button after your required set time is reached. Then press TIMER button to confirm it. T-ON and H icon will stop blinking.
- Cancel Timer On/Off: If Timer function is set up, press TIMER button once to review the remaining time. Within 5 seconds, press TIMER button again to cancel this function.

**Note:**

- Range of time setting is: 0.5~24h.
- The interval between two motions can't exceed 5 seconds, otherwise the remote control will exit setting status.

**Child lock function**

Pressing “+” and “-” buttons simultaneously can turn on or turn off child lock function. When child lock function is started, LOCK indicator on remote control is ON. If you operate the remote control, remote control won't send signal.

**Temperature display switchover function**

Under OFF status, press “-” button and “MODE” button simultaneously can switch between °C and °F.

1. After putting through the power, press “ON/OFF” button on remote controller to turn on the air conditioner.
2. Press “MODE” button to select your required mode: AUTO, COOL, FAN, HEAT.
3. Press “+” or “-” button to set your required temperature. (Temperature can't be adjusted under auto mode).
4. Press “FAN” button to set your required fan speed: auto, low, medium and high speed..

**NOTICE**

- During operation, point the remote control signal sender at the receiving window on indoor unit.
- The distance between signal sender and receiving window should be no more than 26ft, and there should be no obstacles between them.
- Fluorescent lamp or wireless telephone may interfere with the signal. Remote control should be close to indoor unit during operation.
- Replace new batteries of the same model when replacement is required.
- When you don't use remote controller for a long time, please take out the batteries.
- If the display on remote controller is fuzzy or there's no display, replace the batteries.

**AUXILIARY CONTROLS-DIP SWITCHES**

The auxiliary dip switch controls are located behind the room cabinet-as shown in the following figure.

The owner is responsible for checking switches and ensuring they are in the desired position.

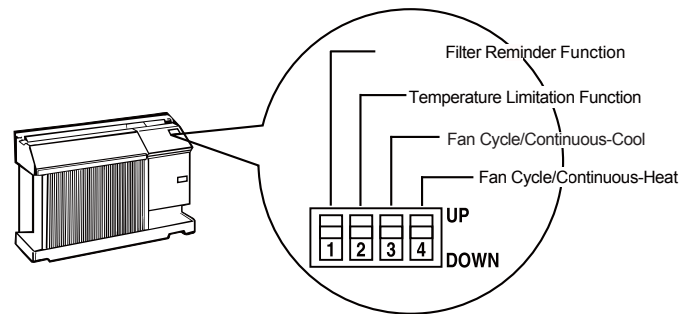
**Filter Reminder Function**

When this switch is enabled (*DOWN*), an LED will light up the user interface after 250 hrs. of accumulated fan run time. It serves as a reminder to clean the filter. When this switch is disabled (*UP*), the function is disabled. The default setting is *DOWN* (enabled).

**Temperature limitation function**

When this switch is disabled (*DOWN*), the setting temp range is from 61°F to 86°F. When this switch is enabled (*UP*), the setting temp range is from 65°F to 86°F in cooling and 61°F to 78°F in heating. The default setting is *DOWN* (disabled).

**Fan Cycle/Continuous - Cool**

When this switch is enabled (*DOWN*), it allows the indoor fan to cycle on/off with the compressor. When this switch is disabled (*UP*), it allows the indoor fan to run continuously. The default setting is *DOWN* (fan cycle).

**Fan Cycle/Continuous - Heat**

When this switch is enabled (*DOWN*), it allows the indoor fan to cycle on/off with the heater or the compressor operation. When this switch is disabled (*UP*), it allows the indoor fan to run continuously. The default setting is *DOWN* (fan cycle).

## AUXILIARY CONTROLS-DIP SWITCHES

The auxiliary dip switch controls are located behind the room cabinet-as shown in this figure. The owner is responsible for checking switches and ensuring they are in the desired position.

For models:

26TTW09AC230V1A-T 26TTW09HC230V1A-T  
26TTW12AC230V1A-T 26TTW12HC230V1A-T  
26TTW09HP230V1A-T 26TTW12HP230V1A-T  
26TTW09AC115V1A-T 26TTW12AC115V1A-T  
26TTW09HP115V1A-T 26TTW07HP230V1A-T

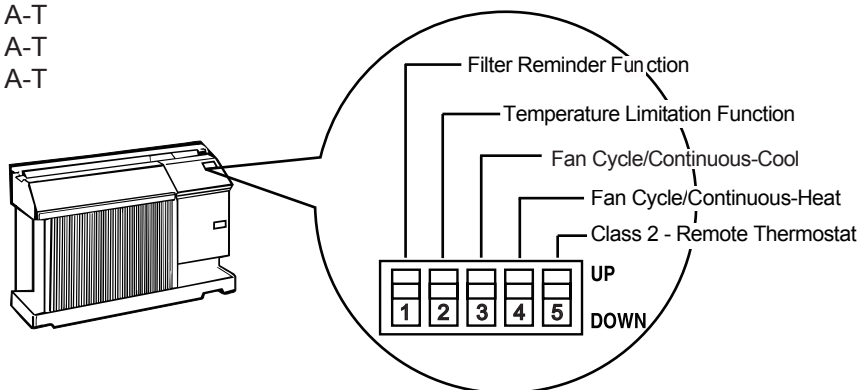

### Temperature limitation function

When this switch is disabled (**DOWN**), the setting temp range from 61°F to 86°F. When this switch is enabled (**UP**), the setting temp range from 65°F to 86°F in cooling and 61°F to 78°F in heating. The default setting is **DOWN** (disabled). Display always shows full range (61°F (16 °C) to 86°F (30 °C)).

### Filter Reminder Function

When this switch is enabled (**DOWN**), an LED will light up the user interface after 250 hrs of accumulated fan run time. It serves as a reminder to clean the filter. When this switch is disabled (**UP**), the function is disabled. The default setting is **DOWN** (enabled).

### Fan Cycle/Continuous - Cool

When this switch is enabled (**DOWN**), it allows the indoor fan to cycle on/off with the compressor. When this switch is disabled (**UP**), it allows the indoor fan to run continuously. The default setting is **DOWN** (fan cycle).

### Fan Cycle/Continuous - Heat

When this switch is enabled (**DOWN**), it allows the indoor fan to cycle on/off with the heater or the compressor operation. When this switch is disabled (**UP**), it allows the indoor fan to run continuously. The default setting is **DOWN** (fan cycle).

### 24 Volt AC - Remote Thermostat

When this switch is enabled (**UP**), it allows the unit to operate with a 24 Volt AC Remote Control Wall Thermostat. The unit controls are disabled. The default setting is **DOWN** (disabled).

# AIR CONDITIONER FEATURES (continued)

## TO TURN UNIT ON:

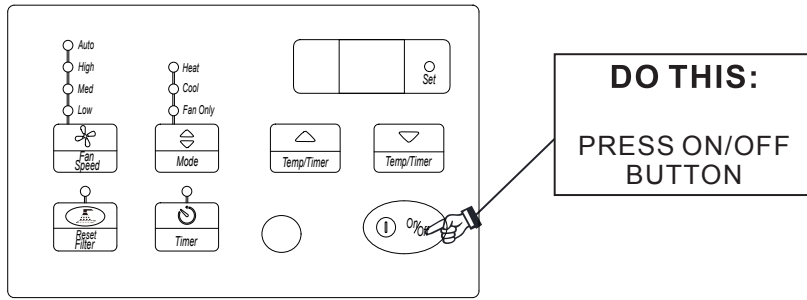

**DO THIS:**  
PRESS ON/OFF  
BUTTON

## YOU WILL SEE:

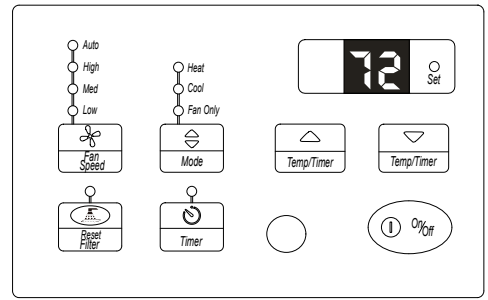

## TO CHANGE TEMPERATURE SETTING:

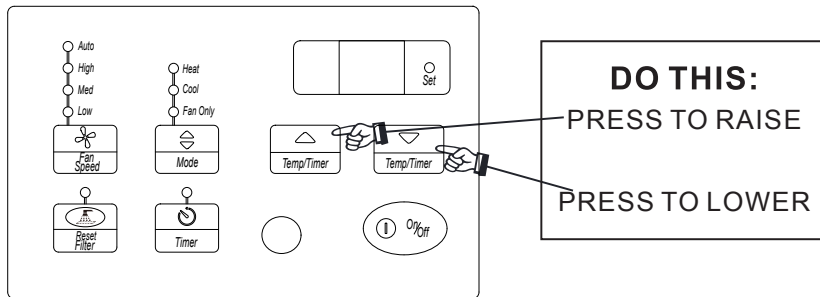

**DO THIS:**  
PRESS TO RAISE  
PRESS TO LOWER

## YOU WILL SEE:

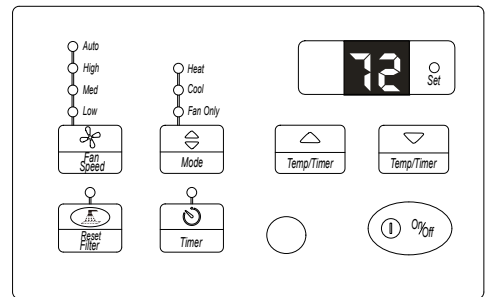

Note: Press or hold either up(Δ) or down(▽) button until the desired temperature is seen on display. This temperature will be automatically maintained anywhere between 61°F (16°C) and 86°F (30°C) for both cooling and heating modes. If you want the display to read the actual room temperature, "Select the fan only mode".

## TO CHANGE FAN SPEEDS:

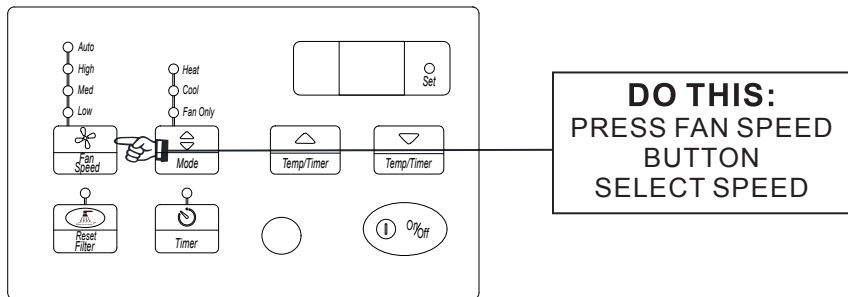

**DO THIS:**  
PRESS FAN SPEED  
BUTTON  
SELECT SPEED

## YOU WILL SEE THE SPEED CHOSEN:

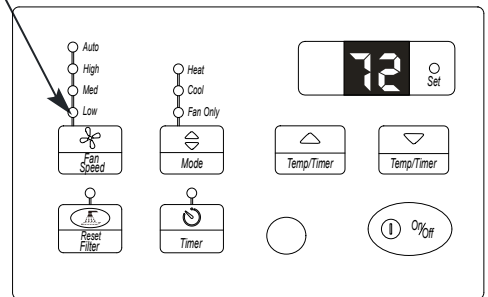

## TO USE AUTO FAN FEATURE:

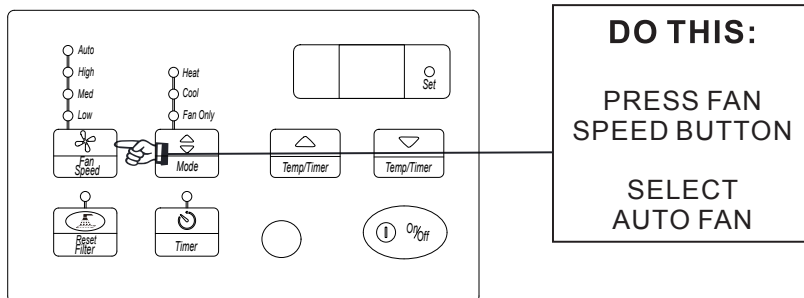

**DO THIS:**  
PRESS FAN  
SPEED BUTTON  
SELECT  
AUTO FAN

## YOU WILL SEE:

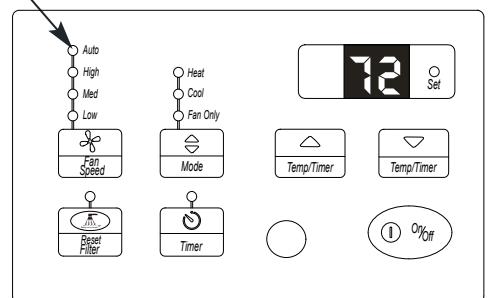

Note: The fan speed will automatically set to the speed needed to provide optimum comfort with the set temperature. If the room needs more cooling, the fan speed will automatically increase. If the room needs less cooling, the fan speed will automatically decrease. Auto fan speed cannot be used when in the Fan Only mode.



## AIR CONDITIONER FEATURES (continued)

### TO OPERATE ON FAN ONLY:

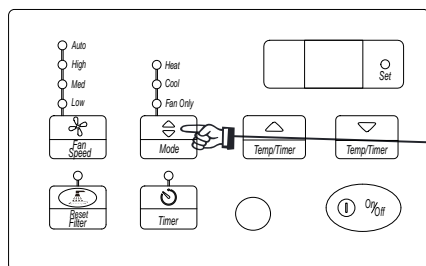

**DO THIS:**

PRESS  
MODE BUTTON

CHOOSE  
FAN ONLY

### YOU WILL SEE:

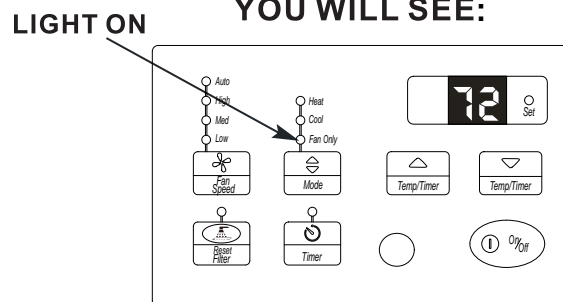

Note: Use this function only when cooling is not desired, such as for room air circulation. You can choose any fan speed you prefer, EXCEPT AUTO FAN. During this function, the display will show the actual current temperature, not the set temperature as in the cooling mode.

### TIMER-DELAY START/STOP FEATURE:

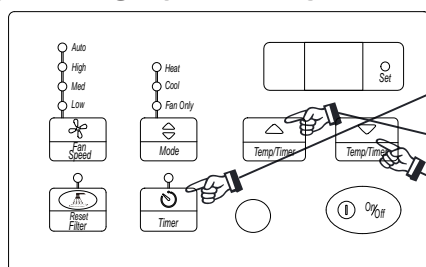

**FIRST DO THIS:**  
PRESS TIMER BUTTON

**THEN  
DO THIS:**  
PRESS TEMP/TIMER  
BUTTON

### YOU WILL SEE THE TIME CHOSEN:

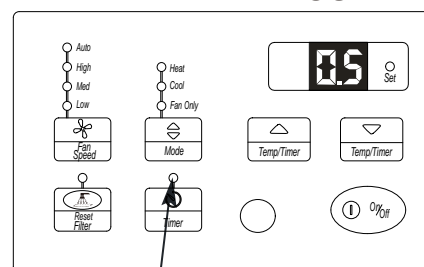

Note 1: For Delay Stop, the unit must be in the ON position.

Note 2: For Delay Start, the unit must be in the OFF position.

To adjust timer setting, tap or hold the UP arrow (^) or DOWN arrow (v) to change the delay time by 0.5 hour increments up to 10 hours, then by 1 hour increments up to 24 hours. The control will count down the timer remaining until start (8, 7.5, 7, etc.). After set Timer, the unit will enter into Timer mode by 5 seconds, then Timer light on, Set light off. In Timer mode: Set temperature and fan speed keeps previously set temperature and fan speed; Temperature display set temperature, no display if power turn off; Press Timer once, LED display remaining time of set time, LED return to set temperature by 5 seconds; When in Fan Only mode, LED only display room temperature, do not display set temperature. Turning the unit "ON" or "OFF" at any timer will cancel the Delay Start/Stop function. The delay Start/Stop feature will work until the unit either starts or stops. Once this has happened then the above steps have to be repeated again.

# AIR CONDITIONER FEATURES (continued)

## COOLING FEATURE (on some models):

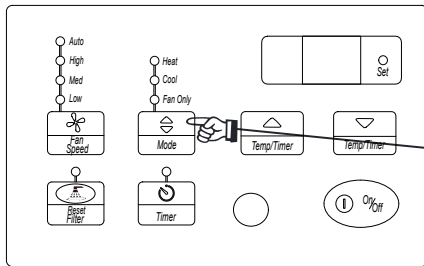

**DO THIS:**  
  
PRESS  
MODE BUTTON  
SELECT COOL

## LIGHT ON YOU WILL SEE:

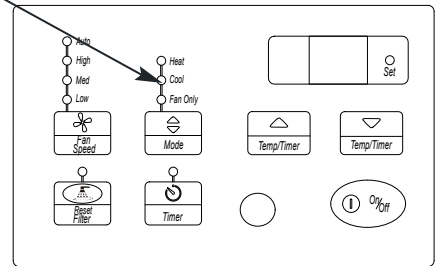

Note: This feature can be used with any combination of FAN Speeds, Timer. When in the “Cool” Mode, the fan will run continuously while cool is needed. The temperature will automatically be maintained anywhere between 61°F (16°C) and 86°F (30°C). When the room set temperature is satisfied, the fan will cycle off and on to circulate and sample the room air. If the air conditioner is off and is then turned on while set to a Cool setting or if turned from a fan setting to a Cool setting, it may take approximately 3 minutes for the compressor to start and cooling to begin.

## HEATING FEATURE (on some models):

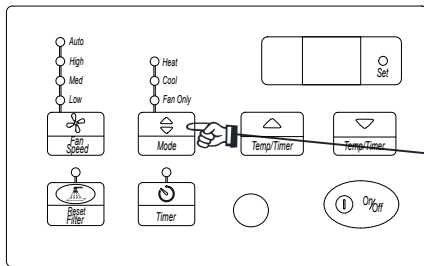

**DO THIS:**  
  
PRESS  
MODE BUTTON  
SELECT HEAT

## LIGHT ON YOU WILL SEE:

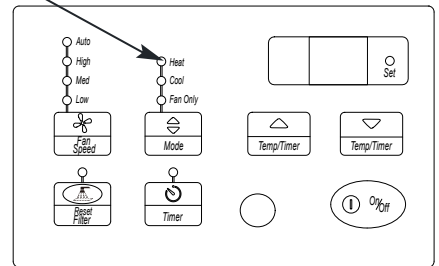

Note: This feature can be used with any combination of FAN Speeds, Timer. When in the “Heat” Mode, the fan will run continuously while heat is needed. The temperature will automatically be maintained anywhere between 61°F (16°C) and 86°F (30°C). When the room set temperature is satisfied, the fan will cycle off and on to circulate and sample the room air.

## RESET FILTER FEATURE :

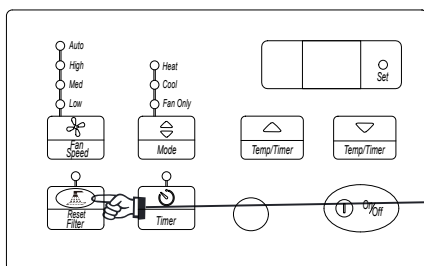

**DO THIS:**  
  
RESET FILTER

## LIGHT ON

## YOU WILL SEE:

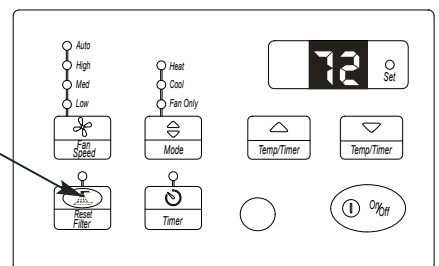

## TO TURN UNIT OFF:

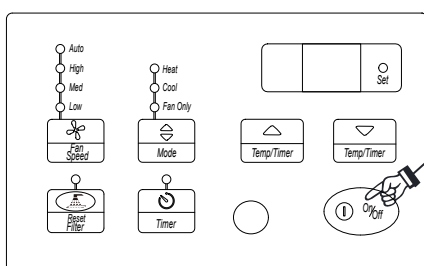

**DO THIS:**  
  
PRESS  
ON/OFF BUTTON

## YOU WILL SEE:

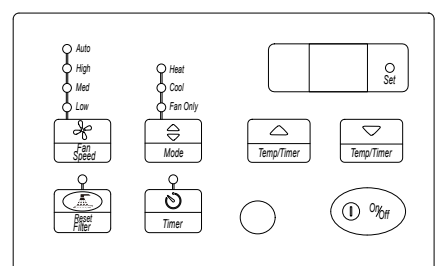

# AIR CONDITIONER FEATURES (continued)

## FAULT CODES

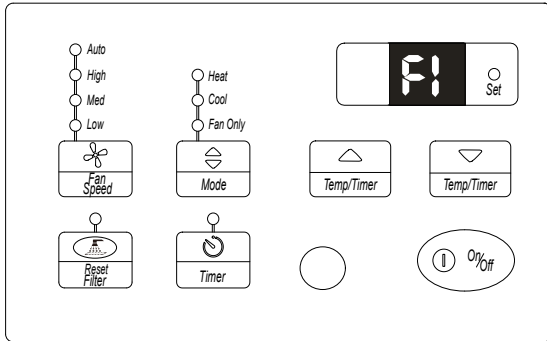

If the display reads “F1” the Ambient temperature sensor has failed

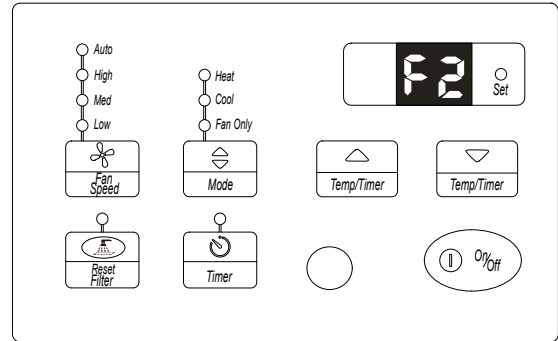

If the display reads “F2” the Inner tube temperature sensor has failed

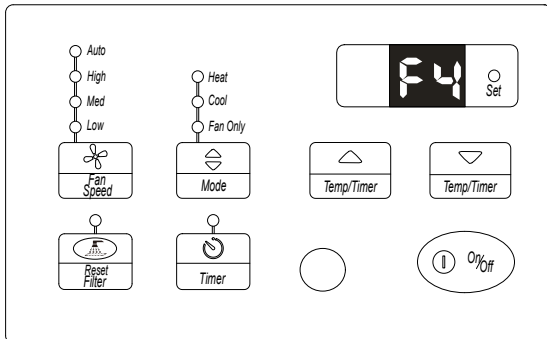

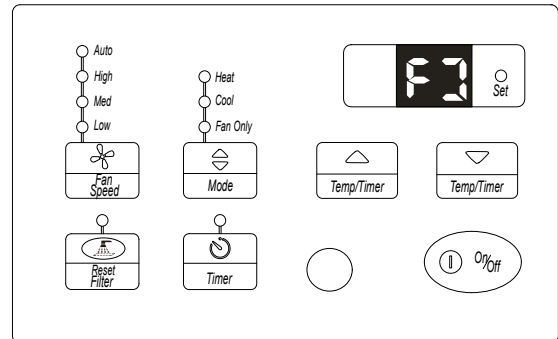

If the display reads “F4” the External tube temperature sensor has failed



If the display reads “FJ” the Air outlet temperature sensor has failed.

## ADDITIONAL THINGS YOU SHOULD KNOW

Now that you have mastered the operating procedure, here are more features in your control that you should know.

- The Remote Control will operate all the control panel features, follow the same instructions.
-  The "Cool "circuit has an automatic 3 minute time delayed start if the unit is turned off and on quickly. This prevents overheating of the compressor and possible circuit breaker tripping. The fan will continue to run during this time. 
- The control will maintain any set temperature between 61°F and 86°F.
- The control is capable of displaying temperature in degrees Fahrenheit or degrees Celsius. To convert from one to the other, press and hold the Up and Down Temperature Selection Pads at the same time for 3 seconds.
- Instructions for installation and use of this product are provided by the manufacturer.

### COMPRESSOR

The compressor is hermetically sealed, permanently lubricated and requires no additional oiling.

### FRONT PANEL AND GRILLE

The front panel and grille can be cleaned with a mild soap or detergent. Do not use hydrocarbon-based cleaners (e.g. acetone, benzene, naphtha, gasoline, etc.) to clean the front panel or grille. Use care when cleaning the control area. Do not use an excessively wet cleaning cloth.

### SCHEDULED MAINTENANCE

To achieve continuing top performance and high efficiency, a regular cleaning/inspection schedule must be established. Maintaining this schedule can be accomplished by either a local maintenance staff or an authorized servicer and must follow the instructions described in this manual.

- If the unit is operated in a dusty climate, dust may collect in the basepan and clog the condenser coil. It is advisable to remove the unit from the sleeve and thoroughly clean the basepan and condenser coil on a periodic basis.
- If the unit is installed ocean side or in a corrosive atmosphere, its life may be greatly reduced by the corrosive environment. Under these conditions, the unit should be removed from the sleeve and completely cleaned once a year. At that time any scratches or blisters on the painted surfaces should be sanded and repainted.

### OUTDOOR COIL CLEANING

The coils on the outdoor side of the air conditioner should be checked regularly. For cleaning outside coil, remove the 6 screws that mount the condenser coil top cover to condenser shroud.



### Normal Operating Sounds and Conditions

#### POPPING OR GURGLING SOUNDS

This sound is the refrigerant traveling through the lines. This is a normal sound which may be heard for a few seconds after the unit shuts off.

#### WATER TRICKLING SOUNDS

This sound is produced by the water as it is picked up and run over the coils. This procedure improves the efficiency of the unit and helps with water removal.

#### WATER DRIPPING

Water will collect in the basepan during high humidity days.

#### STARTING DELAY

You may notice a short delay in the startup if you try to restart the unit too soon after turning it off or if you adjust the thermostat right after the compressor has shut off. This delay protects the compressor.

#### Obtaining Service

In the unlikely event this unit requires repair or servicing beyond what is covered in this manual, contact an authorized service organization.

To obtain an authorized servicer, contact your sales representative or agency.

# Warranty

---

Gree Electric Appliances, Inc. of Zhuhai warrants the accompanying Gree Thru-the -Wall Room Air Conditioner (Models: 26TTW09AC115V1A-T etc) to be free of defects in material and workmanship for the applications specified in its operation instruction for the period of parts specified below.

5 YEARS FOR COMPRESSOR
1 YEAR FOR OTHER COMPONENTS

This warranty shall not apply to broken or marred cabinets, accessories, knobs, filters or routine maintenance. This warranty does not apply to uncrating, setup, installation, removal of the product for repair or reinstallation of the product after repair.

This warranty does not apply to repairs or replacements necessitated by any cause beyond the control of Gree Electric Appliances including, but not limited to, any malfunction, defect or failure caused by or resulting from unauthorized service or parts, improper maintenance, operation contrary to furnished instructions, shipping or transit accidents, modification or repair by the user, abuse, misuse, neglect, accident, incorrect power line voltage, fire, flood or other Acts of God, or normal wear and tear.

Warranty service must be performed by a qualified HVAC contractor. Gree maintains a centralized service network to provide parts and assist in resolving service problems if difficulties are encountered. Gree agrees to provide service information, sell repair parts and reimburse the dealer /serviceman for parts in accordance with Gree Electric Appliances' Policies and Procedures.

GREE ELECTRIC APPLIANCES MAINTAINS THAT ALL WARRANTIES, INCLUDING IMPLIED WARRANTY OR MERCHANTABILITY ARE LIMITED TO THE TERMS AND CONDITIONS SPECIFIED ABOVE. GREE ELECTRIC APPLIANCES DISCLAIMS ANY LIABILITY FOR CONSEQUENTIAL OR INCIDENTAL DAMAGES AND IN NO EVENT SHALL GREE ELECTRIC APPLIANCES' INTERNATIONAL INC.'S LIABILITY EXCEED THE RETAIL VALUE OF THE AIR CONDITIONER.

This warranty covers only new products purchased from our authorized dealers or retailers. It does not cover internet sales, used, salvaged, or refurbished products.

## FOR TECHNICAL SUPPORT AND WARRANTY SERVICE

GREE ELECTRIC APPLIANCES, INC. OF ZHUHAI

West Jinji RD, Qianshan, Zhuhai,  
Guangdong, China. 519070.

Monday through Friday, 9:00 AM to 5:00 PM,

Call : (+86-756)8614883

Email: Global@gree.com.cn

Website: www.gree.com.cn





For more Information: [www. GreeComfort.com](http://www.GreeComfort.com)

Gree Electric Appliances, Inc. 2019 All rights reserved. Cat No. GREE\_26TTW-T\_INSTALL&OWNERS\_010119



66129931033