



# ***Technical Sales Guide***

## **DC INVERTER MULTI VRF INDOOR UNIT**

(GC202003-X)

Capacity Range: 5800~96000Btu/h

Rate Frequency: 60Hz



# CONTENTS

- PRODUCT CHARACTERISTIC..... 1
- UNIT PARAMETERS .....7
- ELECTRICAL SPECIFICATIONS.....40
- COOLING/HEATING CAPACITY CORRECTION .....43
- UNIT NOISE CURVES .....62
- FAN CHARACTERISTICS.....88
- UNIT INSTALLATION SPACE REQUIREMENTS .....98
- REQUIREMENTS FOR COMMUNICATION MODE .....121
- OPTIONAL COMPONENTS.....124

## 1 PRODUCT CHARACTERISTIC

### 1.1 Low Static Pressure Duct Type Indoor Unit

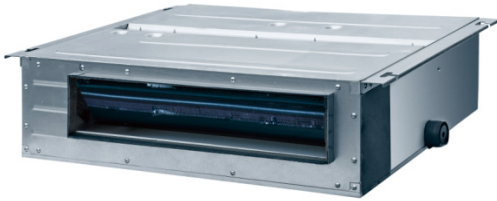
Features	Characteristic
	<ul style="list-style-type: none"> <li>◆ Low static pressure, low noise Especially suitable for rooms of compact structure or small installation space. Also it provides you with a comfortable and quiet living environment.</li> <li>◆ Convenient installation Tab type plastic filter, detachable fan motor, independent water pump assembly, all for convenient maintenance.</li> <li>◆ Intelligent drainage device Water height difference up to 3.3ft. which can effectively drain out condensing water and save space.</li> <li>◆ Protection function Water overflow protection, anti-freezing protection, fan motor overload protection, temperature sensor malfunction protection.</li> </ul>

### 1.2 Slim Duct Type Indoor Unit

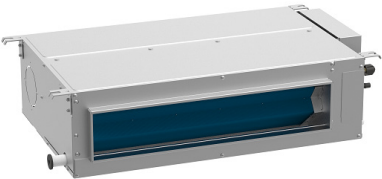
Features	Characteristic
	<ul style="list-style-type: none"> <li>◆ High-efficiency DC brushless motor is used. Its efficiency is improved by over 30% compared with common motor. Evaporator flow path adopts simulating optimized design via the refrigeration system simulation software, which has greatly increased the heat exchange capacity of evaporator.</li> <li>◆ Slim &amp; Small The unit is only 200mm's thick and 450 mm's deep. Suspended ceiling doesn't have to be very high. It is suitable for ordinary rooms</li> <li>◆ Wiring of Electric Control Box Mounting board of electric control box elements are arranged at both sides of the mounting board of fan motor. There is a wire-cross notch on each side so that wiring at both sides of the mounting board of fan motor is convenient and efficient. Strong and weak current are also separated to ensure the effectiveness of weak current signal transmission.</li> <li>◆ Protection Functions Anti - freezing protection, fan motor built-in overload protection, temperature sensor protection.</li> <li>◆ Ultra-quiet High-efficiency centrifugal fan and ultralow noise volute are developed with ANSYS and Fluent. They have also gained national patents. Meanwhile, inlet mute valve is adopted so that noise of the complete unit is greatly reduced.</li> <li>◆ Fast &amp; Strong Intelligent temperature control technology is adopted. Cooling/ Heating function is fast and strong so that room temperature can quickly reach set temperature</li> <li>◆ Flexible Installation Based on the requirements of building and utilization, different ways of air return and different air supply static pressure can be selected.</li> <li>◆ CAN Bus Communication Technology System response speed is faster and communication is more reliable. Auto addressing, non-polar communication, free wire matching.</li> <li>◆ Convenient Operation &amp; Maintenance Electric control box is attached independently so that it can be detached as a whole, which is convenient for fan and motor is also convenient.</li> </ul>

### ➔ 1.3 Four-way Cassette Type Indoor Unit

Features	Characteristic
	<ul style="list-style-type: none"> <li>◆ Strong and balanced airflow Unit features auto operation, Four-way airflow, 7 fan speeds and strong circulating airflow.</li> <li>◆ DC inverter motor With good speed regulation performance, motor efficiency improved by 30% vs. normal motor.</li> <li>◆ Ultra-low noise operation DC inverter motor can realize stepless speed regulation to lower noise. Indoor unit can be set to work under auto quiet mode via wired controller.</li> <li>◆ Protection function Water overflow protection, anti-freezing protection, temperature sensor malfunction protection, fan motor overload protection.</li> <li>◆ Intelligent drainage device Water height difference up to 3.3ft. which can effectively drain out condensing water and save space.</li> </ul>

### ➔ 1.4 High Dstatic Pressure Duct Type Indoor Unit

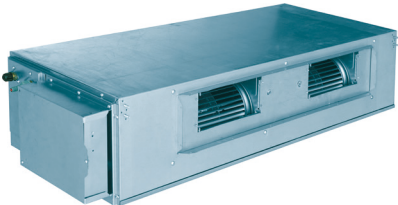
Features	Characteristic
	<ul style="list-style-type: none"> <li>◆ High static pressure design Static pressure can be up to 150Pa(0.6 In.W.G), especially suitable for places in need of long distance airflow.</li> <li>◆ Convenient installation You can choose circular air duct or rectangular air duct according to actual needs. Or you can choose different ways of air return.</li> <li>◆ Easy maintenance The system has maintenance port for easy maintenance.</li> <li>◆ Protection function Anti-freezing protection, fan motor overload protection, temperature sensor malfunction protection.</li> </ul>

### ➔ 1.5 Floor Ceiling Type Indoor Unit

Features	Characteristic
	<ul style="list-style-type: none"> <li>◆ Hoisted or seated, flexible installation Unit can be hoisted or seated. When seated, suspended ceiling is not needed.</li> <li>◆ Protection function Anti-freezing protection, temperature sensor malfunction protection, fan motor overload protection.</li> <li>◆ Beautiful appearance With beautiful and elegant front panel, it is congenial to the indoor surroundings.</li> <li>◆ Horizontal and vertical air swing Wider air swing range for your comfortable working and living environment.</li> </ul>

## ➔ 1.6 Wall Mounted Type Indoor Unit

Features	Characteristic
	<ul style="list-style-type: none"> <li>◆ Filter can be cleaned The filter is removable and can be cleaned for easy maintenance.</li> <li>◆ Quiet design High-efficiency cross flow blade and imported silence valve are adopted, which greatly reduce the noise of entire unit.</li> <li>◆ One IDU with several wired controller and several IDUs with one wired controller One IDU can be connected with several wired controllers in order to control one IDU from different location; meanwhile, several IDUs can be connected with one wired controller in order to achieve centralized control of 16 IDUs in maximum.</li> <li>◆ Wide air supply range The air supply range is wide, so that the wind can be delivered to each corner of the room naturally and evenly.</li> <li>◆ Super cooling and heating function Intelligent temperature control technology is adopted with super cooling and heating function, so that the room temperature can reach set temperature rapidly.</li> <li>◆ I-feel function When I-feel function is activated, the unit can detect the temperature around the user and adjust the temperature, so that the comfort of user is improved. (Remote controller shall be equipped)</li> <li>◆ Panel is removable The panel of indoor unit can be removed easily for convenient maintenance.</li> </ul> <p>The response of the system is quicker with more reliable communication; auto addressing, non-polar communication and free wiring are available.</p> <ul style="list-style-type: none"> <li>◆ Multiple protections Anti-freezing protection, temperature sensor malfunction protection, fan motor overload protection.</li> </ul>

## ➔ 1.7 Fresh Air Processing Type Indoor Unit

Features	Characteristic
	<ul style="list-style-type: none"> <li>◆ Fresh Air Processing Indoor Unit Airflow volume: 589CFM~2060CFM Applicable range: Residential houses, villas, business buildings, hotels, apartments, etc.</li> <li>◆ One system, two functions Adopted with DC inverter technology, Fresh Air DC Inverter Multi VRF System features air conditioning function and fresh air function.</li> <li>◆ Enjoy fresh air</li> <li>◆ Less investment Fresh Air DC Inverter Multi VRF System can be combined with Gree GMV5. For a same room, if the same amount of fresh air is to be taken, then the cost of GMV5+Fresh air unit is equivalent to the cost of GMV+Air exchange fan.</li> <li>◆ Less operation cost Unit can control refrigerant output according to actual needs to ensure constant airflow temperature. By adjusting power output, light-load but high power operation can be avoided. Thus, operation cost can be greatly reduced.</li> <li>◆ Less installation space Save installation space for outdoor units. Especially suitable for places that have restricted installation space.</li> </ul>

### ➔ 1.8 Console Type Indoor Unit

Features	Characteristic
	<ul style="list-style-type: none"> <li>◆ Multiple fan speed The fan can operate in multiple speed and satisfy different air flow volume requirements.</li> <li>◆ High drain pump lift Drain pump lift reaches 1.0m, which can effectively drain out water.</li> <li>◆ Detachable grille and long life filter Grille is detachable for easy cleaning. With long life filter, cleaning cycle is 20 times longer.</li> <li>◆ Protection function Water overflow protection, anti-freezing protection, fan motor overload protection, temperature sensor malfunction protection, auxiliary electric heating overheat protection (This function is not included in pure heat pump unit).</li> </ul>

### ➔ 1.9 Two-way Cassette Type Indoor Unit

Features	Characteristic
	<ul style="list-style-type: none"> <li>◆ Beautiful Appearance With beautiful and elegant front panel, it is congenial to the indoor surroundings.</li> <li>◆ Two-way air flow design Two-way air outlet, to stretch air outlet distance and solve air supply problem of elongated room</li> <li>◆ Intelligent drainage device Water height difference up to 1.0m, which can effectively drain out condensing water and save space.</li> <li>◆ Multiple protections Anti-freezing protection, temperature malfunction protection, fan motor overload and humidity sensor protection.</li> </ul>

### ➔ 1.10 Compact Four-way Cassette Type Indoor Unit

Features	Characteristic
	<ul style="list-style-type: none"> <li>◆ Compact design for easy installation Units maintain the uniform length and width with consistent ceiling opening and panel dimension, convenient for design and installation.</li> <li>◆ Ultra-low noise operation DC inverter motor can realize stepless speed regulation to lower noise. Indoor unit can be set to work under auto quiet mode via wired controller.</li> <li>◆ Intelligent drainage device Water height difference up to 3.3ft. Which can effectively drain out condensing water and save space.</li> </ul>

### ➔ 1.11 Super High Static Pressure Duct Type Indoor Unit

Features	Characteristic
	<ul style="list-style-type: none"> <li>◆ High static pressure design Static pressure can be up to 275Pa(1.1In.W.G), especially suitable for places in need of long distance airflow.</li> <li>◆ Convenient installation You can choose circular air duct or rectangular air duct according to actual needs. Or you can choose different ways of air return.</li> <li>◆ Easy maintenance The system has maintenance port for easy maintenance.</li> <li>◆ Protection function Anti-freezing protection, fan motor overload protection, temperature sensor malfunction protection.</li> </ul>

## ➔ 1.12 Air Handler Type Indoor Unit

Features	Characteristic
	<ul style="list-style-type: none"> <li>◆ Multiple fan speed The fan can operate in multiple speed and satisfy different air flow volume requirements.</li> <li>◆ DC inverter motor With good speed regulation performance, motor efficiency improved by 30% vs. normal motor.</li> <li>◆ Ultra-low noise operation DC inverter motor can realize stepless speed regulation to lower noise. Indoor unit can be set to work under auto quiet mode via wired controller.</li> <li>◆ Protection function Anti-freezing protection, fan motor overload protection, temperature sensor malfunction protection. Anti-freezing protection, fan motor overload protection, temperature sensor malfunction protection.</li> </ul>

## ➔ 1.13 AHU-KIT Type Indoor Unit

Features	Characteristic
	<ul style="list-style-type: none"> <li>◆ Make the air handling unit is with functions and advantages of VRF products . Connected to VRF system of air handling unit and retained the original user function and project application function of VRF system. Installation, debugging, operation and maintenance are more convenient.</li> <li>◆ Multiple installation method for convenient project design. The air handling unit equipped with AHU-KIT has multiple methods for connecting VRF system. It can independently connect to VRF system to compose a one-to-one proposal; it can also match with other air handling unit or general VRF indoor units to connect to the same VRF system for composing a one-to-more proposal. In this case, it is convenient for project design.</li> <li>◆ Independent design, convenient installation. AHU-KIT is composed by two independent boxes( electronic expansion valve and control box) and designed independently, which is convenient for installation and application.</li> <li>◆ Error signal is connected for reliable installation and operation. Error signal of air handling unit is connected to AHU-KIT. Where there's malfunction, the unit will stop operation, same and reliable.</li> </ul>

## ➔ 1.14 1-way Cassette Type

Features	Characteristic
	<ul style="list-style-type: none"> <li>◆ Beautiful Appearance With beautiful and elegant front panel, it is congenial to the indoor surroundings.</li> <li>◆ One-way air flow design One-way air outlet, to stretch air outlet distance and solve air supply problem of elongated room.</li> <li>◆ Intelligent drainage device Water height difference up to 1.0m, which can effectively drain out condensing water and save space.</li> <li>◆ Multiple protections Anti-freezing protection, temperature malfunction protection, fan motor overload and humidity sensor protection.</li> </ul>

### ➔ 1.15 Low static pressure Duct Type Indoor Unit

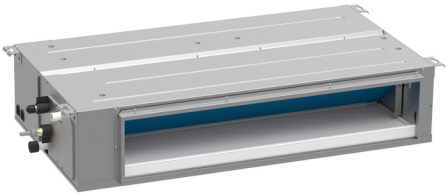
Features	Characteristic
	<ul style="list-style-type: none"> <li>◆ Low static pressure, low noise Especially suitable for rooms of compact structure or small installation space. Also it provides you with a comfortable and quiet living environment.</li> <li>◆ Convenient installation Tab type plastic filter, detachable fan motor, independent water pump assembly, all for convenient maintenance.</li> <li>◆ Intelligent drainage device Water height difference up to 3.3ft. which can effectively drain out condensing water and save space.</li> <li>◆ Protection function Water overflow protection, anti-freezing protection, fan motor overload protection, temperature sensor malfunction protection.</li> </ul>

### ➔ 1.16 360°Air Discharge Compact Cassette Indoor Unit

Features	Characteristic
	<ul style="list-style-type: none"> <li>◆ 360° Air Supply 360°air supply design for wide air supply range and balanced temperature distribution, more comfortable.</li> <li>◆ Independent Swing Control 4 swing blades can be controlled independently; multiple air supply angle combinations is available for free and humanized control, avoiding direct air blow to people.</li> <li>◆ New Air Duct and Blade Design for Low Noise Adopt new air duct and blade with fluid simulation design for lower noise; noise is as low as 25dB.</li> <li>◆ DC Quiet Drainage Pump Water height difference up to 1.2m, which can effectively drain out condensing water and save space. Adopting high-lift DC quiet type drainage pump for lower power consumption and better sound quality; the maximum lifting height is 1200mm; installation is more flexible and the drainage pipe layout is more convenient.</li> </ul>

### ➔ 1.17 360°Air Discharge Cassette Indoor Unit

Features	Characteristic
	<ul style="list-style-type: none"> <li>◆ 360° Air Supply. 360°air supply design for wide air supply range and balanced temperature distribution, more comfortable.</li> <li>◆ Independent Swing Control. 4 swing blades can be controlled independently; multiple air supply angle combinations is available for free and humanized control, avoiding direct air blow to people.</li> <li>◆ Ultra-low noise operation. DC inverter motor can realize stepless speed regulation to lower noise. Indoor unit can be set to work under auto quiet mode via wired controller.</li> <li>◆ DC Quiet Drainage Pump Water height difference up to 1.2m, which can effectively drain out condensing water and save space. Adopting high-lift DC quiet type drainage pump for lower power consumption and better sound quality; the maximum lifting height is 1200mm; installation is more flexible and the drainage pipe layout is more convenient.</li> </ul>



## 2 UNIT PARAMETERS

### 2.1 Low Static Pressure Duct Type Indoor Unit

Model		GMV-ND07PLS/ A-T(U)	GMV-ND09PLS/ A-T(U)	GMV-ND12PLS/ A-T(U)	GMV-ND14PLS/ A-T(U)	GMV-ND18PLS/ A-T(U)	GMV-ND22PLS/ A-T(U)		
Cooling Capacity	Btu/h	7500	9500	12000	15000	18000	24000		
	kW	2.2	2.8	3.5	4.4	5.3	7.0		
Heating Capacity	Btu/h	8500	10500	13500	17000	20000	27000		
	kW	2.5	3.1	4.0	5.0	5.9	7.9		
Casing Finish		Galvanized Steel plate							
Dimensions (W×D×H)	Outline	mm	700×615 ×200	700×615 ×200	700×615 ×200	900×615 ×200	1100×615 ×200	1100×615 ×200	
		in.	27-9/16×24- 3/16×7-7/8	27-9/16×24- 3/16×7-7/8	27-9/16×24- 3/16×7-7/8	35-7/16×24- 3/16×7-7/8	43-5/16×24- 3/16×7-7/8	43-5/16×24- 3/16×7-7/8	
	Packaging	mm	893×743 ×305	893×743 ×305	893×743 ×305	1123×743 ×305	1323×743 ×305	1323×743 ×305	
		in.	35-3/16×29- 1/4×12	35-3/16×29- 1/4×12	35-3/16×29- 1/4×12	44-3/16×29- 1/4×12	52-1/16×29- 1/4×12	52-1/16×29- 1/4×12	
Net Weight	lbs.	51	51	51	60	69	69		
	kg	23	23	23	27	31	31		
Gross Weight	lbs.	64	64	64	73	86	86		
	kg	29	29	29	33	39	39		
Pipe Connection	Liquid Side	mm	Φ6.35	Φ6.35	Φ6.35	Φ6.35	Φ9.52	Φ9.52	
		in.	Φ1/4	Φ1/4	Φ1/4	Φ1/4	Φ3/8	Φ3/8	
	Gas Side	mm	Φ9.52	Φ9.52	Φ12.7	Φ12.7	Φ15.9	Φ15.9	
		in.	Φ3/8	Φ3/8	Φ1/2	Φ1/2	Φ5/8	Φ5/8	
	Drain Pipe	mm	Φ25	Φ25	Φ25	Φ25	Φ25	Φ25	
		in.	Φ1	Φ1	Φ1	Φ1	Φ1	Φ1	
Power Supply		1-phase 208/230V 60Hz							
Fan	Type × Quantity		Centrifugal×2	Centrifugal×2	Centrifugal×2	Centrifugal×3	Centrifugal×4	Centrifugal×4	
	Driving Mechanism		Direct-driven						
	Motor Type		BLDC						
	Motor Power Input	W	43	43	43	52	99	99	
	Motor Running Current	A	0.3	0.3	0.3	0.5	0.7	0.7	
	Airflow Rate (H/M/L)	CFM	265/235/147	265/235/147	324/265/206	412/353/265	589/471/353	589/471/353	
		m <sup>3</sup> /h	450/400/250	450/400/250	550/450/350	700/600/450	1000/800/600	1000/800/600	
	External Static Pressure	Default	in.W.G.	0.06	0.06	0.06	0.06	0.06	0.06
			Pa	15	15	15	15	15	15
		Range	in.W.G.	0~0.12	0~0.12	0~0.12	0~0.12	0~0.12	0~0.12
Pa			0~30	0~30	0~30	0~30	0~30	0~30	
Sound Pressure Level(H/M/L)		dB(A)	31/29/25	31/29/25	32/30/27	33/31/28	35/33/30	35/33/30	
Heat Exchanger		Fenestrate plain film --hydrophilic film							
Air Filter		PP							
Refrigeration Control Device		EXV							
Protection Device		Fuse							

## 2.2 Slim Duct Type Indoor Unit

Model		GMV-ND07PLS/ B-T(U)	GMV-ND09PLS/ B-T(U)	GMV-ND12PLS/ B-T(U)	GMV-ND14PLS/ B-T(U)	GMV-ND18PLS/ B-T(U)	GMV-ND24PLS/ B-T(U)		
Cooling Capacity	Btu/h	7500	9500	12000	15000	18000	24000		
	kW	2.2	2.8	3.6	4	5.6	7.1		
Heating Capacity	Btu/h	9500	10500	13500	17000	20000	27000		
	kW	2.8	3.2	4	4.5	6.3	8		
Casing Finish		Galvanized Steel plate							
Dimensions (W×D×H)	Outline	mm	710×462×200	710×462×200	710×462×200	1010×462×200	1010×462×200	1310×462×200	
		in.	27-15/16×18-3/16×7-14/16	27-15/16×18-3/16×7-14/16	27-15/16×18-3/16×7-14/16	39-12/16×18-3/16×7-14/16	39-12/16×18-3/16×7-14/16	51-9/16×18-3/16×7-14/16	
	Packaging	mm	1025×570×285	1025×570×285	1025×570×285	1322×570×285	1625×570×285	1625×570×285	
		in.	40-4/16×22-5/16×10-10/16	40-4/16×22-5/16×10-10/16	40-4/16×22-5/16×10-10/16	52-1/16×22-5/16×10-10/16	52-1/16×22-5/16×10-10/16	64×22-5/16×10-10/16	
Net Weight	lbs.	40.8	40.8	41.9	55.1	55.1	68.4		
	kg	18.5	18.5	19	25	25	31		
Gross Weight	lbs.	51.8	51.8	52.9	68.4	68.4	82.7		
	kg	23.5	23.5	24	31	31	37.5		
Pipe Connection	Liquid Side	mm	Φ6.35	Φ6.35	Φ6.35	Φ6.35	Φ9.52	Φ9.52	
		in.	Φ1/4	Φ1/4	Φ1/4	Φ1/4	Φ3/8	Φ3/8	
	Gas Side	mm	Φ9.52	Φ9.52	Φ12.7	Φ12.7	Φ15.9	Φ15.9	
		in.	Φ3/8	Φ3/8	Φ1/2	Φ1/2	Φ5/8	Φ5/8	
	Drain Pipe	mm	Φ25	Φ25	Φ25	Φ25	Φ25	Φ25	
		in.	Φ1	Φ1	Φ1	Φ1	Φ1	Φ1	
Power Supply		1-phase 208/230V 60Hz							
Fan	Type × Quantity		Centrifugal×2	Centrifugal×2	Centrifugal×2	Centrifugal×3	Centrifugal×4	Centrifugal×4	
	Driving Mechanism		Direct-driven						
	Motor Type		BLDC						
	Motor Power Input	W	30	30	30	30	60	80	
	Motor Running Current	A	0.16	0.16	0.16	0.16	0.29	0.3	
	Airflow Rate (H/M/L)	CFM	265/206/118	265/206/118	324/235/177	441/324/235	500/412/324	647/500/383	
		m <sup>3</sup> /h	450/350/200	450/350/200	550/400/300	750/550/400	850/700/550	1100/850/600	
	External Static Pressure	Default	in.W.G.	0.06	0.06	0.06	0.06	0.06	0.06
			Pa	15	15	15	15	15	15
		Range	in.W.G.	0~0.12	0~0.12	0~0.12	0~0.12	0~0.12	0~0.12
Pa			0~30	0~30	0~30	0~30	0~30	0~30	
Sound Pressure Level(H/M/L)	dB(A)	30/25/22	30/25/22	31/27/25	33/29/27	35/31/29	37/32/30		
Heat Exchanger		Fenestrate plain film --hydrophilic film							
Air Filter		PP							
Refrigeration Control Device		EXV							
Protection Device		Fuse							

# DC INVERTER MULTI VRF INDOOR UNIT TECHNICAL SALES GUIDE

## 2.3 Four-way Cassette Type

Model		GMV-ND07T/ A-T(U)	GMV-ND09T/ A-T(U)	GMV-ND12T/ A-T(U)	GMV-ND15T/ A-T(U)	GMV-ND18T/ A-T(U)	
Cooling Capacity	Btu/h	7500	9500	12000	15000	18000	
	kW	2.2	2.8	3.5	4.4	5.3	
Heating Capacity	Btu/h	8500	10500	13500	17000	20000	
	kW	2.5	3.1	4.0	5	5.9	
Casing Finish		Galvanized Steel plate					
Dimensions (W×D×H)	Body Outline	mm	840×840×190	840×840×240	840×840×240	840×840×240	840×840×240
		in.	33×33×7-1/2	33×33×9-1/2	33×33×9-1/2	33×33×9-1/2	33×33×9-1/2
	Body Packaging	mm	963×963×272	963×963×325	963×963×325	963×963×325	963×963×325
		in.	37-15/16×37-15/16×10-11/16	37-15/16×37-15/16×12-13/16	37-15/16×37-15/16×12-13/16	37-15/16×37-15/16×12-13/16	37-15/16×37-15/16×12-13/16
	Panel Outline	mm	950×950×65	950×950×65	950×950×65	950×950×65	950×950×65
		in.	37-3/8×37-3/8×2-1/2	37-3/8×37-3/8×2-1/2	37-3/8×37-3/8×2-1/2	37-3/8×37-3/8×2-1/2	37-3/8×37-3/8×2-1/2
	Panel Packaging	mm	1033×1038×133	1033×1038×133	1033×1038×133	1033×1038×133	1033×1038×133
		in.	40-11/16×40-7/8×5-1/4	40-11/16×40-7/8×5-1/4	40-11/16×40-7/8×5-1/4	40-11/16×40-7/8×5-1/4	40-11/16×40-7/8×5-1/4
Net Weigh	Main Body	lbs.	50	58	58	58	58
		kg	22.5	26.5	26.5	26.5	26.5
	Panel	lbs.	15	15	15	15	15
		kg	7	7	7	7	7
Gross Weigh	Main Body	lbs.	64	75	75	75	75
		kg	29	34	34	34	34
	Panel	lbs.	24	24	24	24	24
		kg	11	11	11	11	11
Pipe Connections	Liquid Side	mm	Φ6.35	Φ6.35	Φ6.35	Φ6.35	Φ9.52
		in.	Φ1/4	Φ1/4	Φ1/4	Φ1/4	Φ3/8
	Gas Side	mm	Φ9.52	Φ9.52	Φ12.7	Φ12.7	Φ15.9
		in.	Φ3/8	Φ3/8	Φ1/2	Φ1/2	Φ5/8
	Drain Pipe	mm	Φ25	Φ25	Φ25	Φ25	Φ25
		in.	Φ1	Φ1	Φ1	Φ1	Φ1
Power supply		1-phase 208/230V 60Hz					
Fan	Type × Quantity		Centrifugal×1	Centrifugal×1	Centrifugal×1	Centrifugal×1	Centrifugal×1
	Driving Mechanism		Direct-driven	Direct-driven	Direct-driven	Direct-driven	Direct-driven
	Motor Type		BLDC	BLDC	BLDC	BLDC	BLDC
	Motor Power Input	W	48	59	59	59	59
	Motor Running Current	mm	0.3	0.5	0.5	0.5	0.5
	Airflow Rate (H/M/L)	CFM	440/385/325	590/530/440	590/530/440	590/530/440	590/530/440
		m <sup>3</sup> /h	750/650/550	1000/900/750	1000/900/750	1000/900/750	1000/900/750
Sound Pressure Level(H/M/L)	dB(A)	36/34/31	37/35/32	37/35/32	37/35/32	37/35/32	
Heat Exchanger		Fenestrate plain film --hydrophilic film					
Air Filter		PP					
Insulation Material		Foamed polystyrene					
Refrigeration Control Device		EXV					
Protection Device		Fuse					
Panel Name		TC01					

Model		GMV-ND24T/ A-T(U)	GMV-ND30T/ A-T(U)	GMV-ND36T/ A-T(U)	GMV-ND42T/ A-T(U)	GMV-ND48T/ A-T(U)	
Cooling Capacity	Btu/h	24000	30000	36000	42000	48000	
	kW	7	8.8	10.6	12.3	14.1	
Heating Capacity	Btu/h	27000	34000	40000	47000	54000	
	kW	7.9	10	11.7	13.8	15.8	
Casing Finish		Galvanized Steel plate					
Dimensions (W×D×H)	Body Outline	mm	840×840×240	840×840×320	840×840×320	840×840×320	840×840×320
		in.	33×33×9-1/2	33×33×12-5/8	33×33×12-5/8	33×33×12-5/8	33×33×12-5/8
	Body Packaging	mm	963×963×325	963×963×409	963×963×409	963×963×409	963×963×409
		in.	37-15/16×37-15/16×12-13/16	37-15/16×37-15/16×16-1/8	37-15/16×37-15/16×16-1/8	37-15/16×37-15/16×16-1/8	37-15/16×37-15/16×16-1/8
	Panel Outline	mm	950×950×65	950×950×65	950×950×65	950×950×65	950×950×65
		in.	37-3/8×37-3/8×2-1/2	37-3/8×37-3/8×2-1/2	37-3/8×37-3/8×2-1/2	37-3/8×37-3/8×2-1/2	37-3/8×37-3/8×2-1/2
	Panel Packaging	mm	1033×1038×133	1033×1038×133	1033×1038×133	1033×1038×133	1033×1038×133
		in.	40-11/16×40-7/8×5-1/4	40-11/16×40-7/8×5-1/4	40-11/16×40-7/8×5-1/4	40-11/16×40-7/8×5-1/4	40-11/16×40-7/8×5-1/4
Net Weigh	Main Body	lbs.	58	72	72	72	72
		kg	26.5	32.5	32.5	32.5	32.5
	Panel	lbs.	15	15	15	15	15
		kg	7	7	7	7	7
Gross Weigh	Main Body	lbs.	75	88	88	88	88
		kg	34	40	40	40	40
	Panel	lbs.	24	24	24	24	24
		kg	11	11	11	11	11
Pipe Connections	Liquid Side	mm	Φ9.52	Φ9.52	Φ9.52	Φ9.52	Φ9.52
		in.	Φ3/8	Φ3/8	Φ3/8	Φ3/8	Φ3/8
	Gas Side	mm	Φ15.9	Φ15.9	Φ15.9	Φ15.9	Φ15.9
		in.	Φ5/8	Φ5/8	Φ5/8	Φ5/8	Φ5/8
	Drain Pipe	mm	Φ25	Φ25	Φ25	Φ25	Φ25
		in.	Φ1	Φ1	Φ1	Φ1	Φ1
Power Supply		1-phase 208/230V 60Hz					
Fan	Type × Quantity		Centrifugal×1	Centrifugal×1	Centrifugal×1	Centrifugal×1	Centrifugal×1
	Driving Mechanism		Direct-driven	Direct-driven	Direct-driven	Direct-driven	Direct-driven
	Motor Type		BLDC	BLDC	BLDC	BLDC	BLDC
	Motor Power Input	W	68	98	110	110	110
	Motor Running Current	A	0.5	0.8	0.9	0.9	0.9
	Airflow Rate (H/M/L)	CFM	695/590/470	885/795/650	1000/825/650	1095/885/680	1095/885/680
m <sup>3</sup> /h		1180/1000/800	1500/1350/1100	1700/1400/1100	1860/1500/1150	1860/1500/1150	
Sound Pressure Level(H/M/L)	dB(A)	38/36/33	40/38/35	41/38/36	43/41/38	43/41/38	
Heat Exchanger	Fenestrate plain film --hydrophilic film						
Air Filter	PP						
Insulation Material	Foamed polystyrene						
Refrigeration Control Device	EXV						
Protection Device	Fuse						
Panel Name	TC01						

# DC INVERTER MULTI VRF INDOOR UNIT TECHNICAL SALES GUIDE



## 2.4 High Static Pressure Duct Type Indoor Unit

Model		GMV-ND18PHS/A-T(U)	GMV-ND24PHS/A-T(U)	GMV-ND30PHS/A-T(U)	GMV-ND36PHS/A-T(U)		
Cooling Capacity	Btu/h	18000	24000	30000	36000		
	kW	5.3	7.0	8.8	10.6		
Heating Capacity	Btu/h	20000	27000	34000	40000		
	kW	5.9	7.9	10	11.7		
Casing Finish		Galvanized Steel plate					
Dimensions (W×D×H)	Outline	mm	1271×558×268	1271×558×268	1229×775×290	1229×775×290	
		in.	50×22×10-1/2	50×22×10-1/2	48-3/8×30-1/2×11-3/8	48-3/8×30-1/2×11-3/8	
	Packaging	mm	1348×597×283	1348×597×283	1338×877×305	1338×877×305	
		in.	53 1/16×23-3/8×11 1/8	53 1/16×23-3/8×11 1/8	52-11/16×34-1/2×12	52-11/16×34-1/2×12	
Net Weight	lbs.	77	77	104	104		
	kg	35	35	47	47		
Gross Weight	lbs.	88	88	119	119		
	kg	40	40	54	54		
Pipe Connections	Liquid Side	mm	Φ9.52	Φ9.52	Φ9.52	Φ9.52	
		in.	Φ3/8	Φ3/8	Φ3/8	Φ3/8	
	Gas Side	mm	Φ15.9	Φ15.9	Φ15.9	Φ15.9	
		in.	Φ5/8	Φ5/8	Φ5/8	Φ5/8	
	Drain Pipe	mm	Φ20	Φ20	Φ20	Φ20	
		in.	Φ3/4	Φ3/4	Φ3/4	Φ3/4	
Power Supply		1-phase 208/230V 60Hz					
Fan	Type × Quantity		Centrifugal×2	Centrifugal×2	Centrifugal×2	Centrifugal×2	
	Driving Mechanism		Direct-driven	Direct-driven	Direct-driven	Direct-driven	
	Motor Type		BLDC	BLDC	BLDC	BLDC	
	Motor Power Input	W	120	130	200	200	
	Motor Running Current	A	0.9	0.9	1.4	1.4	
	Airflow Rate (H/M/L)	CFM	590/470/355	650/530/410	1000/855/650	1000/855/650	
		m <sup>3</sup> /h	1000/800/600	1100/900/700	1700/1450/1100	1700/1450/1100	
	External Static Pressure	Default	in.W.G	0.28	0.28	0.28	0.28
			Pa	70	70	70	70
		Range	in.W.G	0~0.4	0~0.4	0~0.4	0~0.4
Pa			0~100	0~100	0~100	0~100	
Sound Pressure Level(H/M/L)	dB(A)	44/40/36	45/41/37	46/44/42	46/44/42		
Heat Exchanger		Fenestrate plain film -- hydrophilic film					
Air Filter		PP					
Insulation Material		Foamed polystyrene					
Refrigeration Control Device		EXV					
Protection Device		Fuse					

Model		GMV-ND42PHS/ A-T(U)	GMV-ND48PHS/ A-T(U)	GMV-ND72PH/ A-T(U)	GMV-ND96PH/ A-T(U)		
Cooling Capacity	Btu/h	42000	48000	69000	92000		
	kW	12.3	14.1	20.2	27.0		
Heating Capacity	Btu/h	47000	54000	77000	103000		
	kW	13.8	15.8	22.6	30.2		
Casing Finish		Galvanized Steel plate					
Dimensions (W×D×H)	Outline	mm	1229×775×290	1229×775×290	1483×791×385	1686×870×450	
		in.	48-3/8×30-1/2×11-3/8	48-3/8×30-1/2×11-3/8	58-3/8×31-1/8×15-3/16	66-3/8×34-1/4×17-3/4	
	Packaging	mm	1338×877×305	1338×877×305	1578×883×472	1788×988×580	
		in.	52-11/16×34-1/2×12	52-11/16×34-1/2×12	62-1/8×34-3/4×18-5/8	70-3/8×38-7/8×22-7/8	
Net Weight	lbs.	104	104	181	232		
	kg	47	47	82	105		
Gross Weight	lbs.	119	119	229	309		
	kg	54	54	104	140		
Pipe Connections	Liquid Side	mm	Φ9.52	Φ9.52	Φ9.52	Φ9.52	
		in.	Φ3/8	Φ3/8	Φ3/8	Φ3/8	
	Gas Side	mm	Φ15.9	Φ15.9	Φ19.05	Φ22.2	
		in.	Φ5/8	Φ5/8	Φ3/4	Φ7/8	
	Drain Pipe	mm	Φ20	Φ20	Φ25	Φ25	
		in.	Φ3/4	Φ3/4	Φ1	Φ1	
Power Supply		1-phase 208/230V 60Hz					
Fan	Type × Quantity		Centrifugal×2	Centrifugal×2	Centrifugal×2	Centrifugal×2	
	Driving Mechanism		Direct-driven	Direct-driven	Direct-driven	Direct-driven	
	Motor Type		BLDC	BLDC	BLDC	BLDC	
	Motor Power Input	W	220	220	800	900	
	Motor Running Current	A	1.6	1.6	5	6	
	Airflow Rate (H/M/L)	CFM	1180/910/705	1180/1000/825	2355/2120/1885	2590/2355/2120	
		m <sup>3</sup> /h	2000/1550/1200	2000/1700/1400	4000/3600/3200	4400/4000/3600	
	External Static Pressure	Default	in.W.G	0.28	0.28	0.4	0.4
			Pa	70	70	100	100
		Range	in.W.G	0~0.4	0~0.4	0.2~0.8	0.2~0.8
Pa			0~100	0~100	50~200	50~200	
Sound Pressure Level(H/M/L)		dB(A)	48/45/42	48/46/44	54/52/49	55/52/50	
Heat Exchanger		Fenestrate plain film -- hydrophilic film	Fenestrate plain film -- hydrophilic film	/	/		
Air Filter		PP	PP	PP			
Insulation Material		Foamed polystyrene					
Refrigeration Control Device		EXV					
Protection Device		Fuse					

# DC INVERTER MULTI VRF INDOOR UNIT TECHNICAL SALES GUIDE

## 2.5 Floor Ceiling Type Indoor Unit

Model		GMV-ND09ZD/A-T(U)	GMV-ND12ZD/A-T(U)	GMV-ND18ZD/A-T(U)	GMV-ND24ZD/A-T(U)	
Cooling Capacity	Btu/h	9500	12000	18000	24000	
	kW	2.8	3.5	5.3	7.0	
Heating Capacity	Btu/h	10500	13500	20000	27000	
	kW	3.1	4.0	5.9	7.9	
Casing Finish		Galvanized Steel plate				
Dimensions (W×D×H)	Outline	mm	1220×700×225	1220×700×225	1220×700×225	1420×700×245
		in.	48×27-9/16×8-7/8	48×27-9/16×8-7/8	48×27-9/16×8-7/8	55-7/8×27-9/16×9 5/8
	Packaging	mm	1343×823×315	1343×823×315	1343×823×315	1548×828×345
		in.	52-7/8×32-3/8×12-3/8	52-7/8×32-3/8×12-3/8	52-7/8×32-3/8×12-3/8	60-15/16×32-5/8×13-9/16
Net Weight	lbs.	88	88	88	110	
	kg	40	40	40	50	
Gross Weight	lbs.	108	108	108	128	
	kg	49	49	49	58	
Pipe Connection	Liquid Side	mm	Φ6.35	Φ6.35	Φ9.52	Φ9.52
		in.	Φ1/4	Φ1/4	Φ3/8	Φ3/8
	Gas Side	mm	Φ9.52	Φ12.7	Φ15.9	Φ15.9
		in.	Φ3/8	Φ1/2	Φ5/8	Φ5/8
	Drain Pipe	mm	Φ17	Φ17	Φ17	Φ17
		in.	Φ11/16	Φ11/16	Φ11/16	Φ11/16
Power Supply		1-phase 208/230V 60Hz				
Fan	Type × Quantity		Centrifugal×4	Centrifugal×4	Centrifugal×4	Centrifugal×3
	Driving Mechanism		Direct-driven			
	Motor Type		BLDC	BLDC	BLDC	BLDC
	Motor Power Input	W	40	40	50	75
	Motor Running Current	A	0.5	0.5	0.5	0.55
	Airflow Rate(H/M/L)	CFM	380/345/305	380/345/305	560/510/410	825/675/640
m <sup>3</sup> /h		650/585/520	650/585/520	950/865/699	1400/1150/1085	
Sound Pressure Level (H/M/L)	dB(A)	36/34/32	36/34/32	42/38/33	44/42/39	
Air Filter		PP				
Insulation Material		Foamed polystyrene				
Refrigeration Control Device		EXV				
Protection Device		Fuse				

Model		GMV-ND30ZD/A-T(U)	GMV-ND36ZD/A-T(U)	GMV-ND42ZD/A-T(U)	GMV-ND48ZD/A-T(U)	
Cooling Capacity	Btu/h	30000	36000	42000	48000	
	kW	8.8	10.6	12.3	14.1	
Heating Capacity	Btu/h	33000	40000	47000	54000	
	kW	10.0	11.7	13.8	15.8	
Casing Finish		Galvanized Steel plate				
Dimensions (W×D×H)	Outline	mm	1420×700×245	1700×700×245	1700×700×245	1700×700×245
		in.	55-7/8×27-9/16×9-5/8	66-15/16×27-9/16×9-5/8	66-15/16×27-9/16×9-5/8	66-15/16×27-9/16×9-5/8
	Packaging	mm	1548×828×345	1828×828×345	1828×828×345	1828×828×345
		in.	60-15/16×32-5/8×13-9/16	71-15/16×32-5/8×13-9/16	71-15/16×32-5/8×13-9/16	71-15/16×32-5/8×13-9/16
Net Weight	lbs.	110	132	132	132	
	kg	50	60	60	60	
Gross Weight	lbs.	128	150	150	150	
	kg	58	68	68	68	
Pipe Connection	Liquid Side	mm	Φ9.52	Φ9.52	Φ9.52	Φ9.52
		in.	Φ3/8	Φ3/8	Φ3/8	Φ3/8
	Gas Side	mm	Φ15.9	Φ15.9	Φ15.9	Φ15.9
		in.	Φ5/8	Φ5/8	Φ5/8	Φ5/8
	Drain Pipe	mm	Φ17	Φ17	Φ17	Φ17
		in.	Φ11/16	Φ11/16	Φ11/16	Φ11/16
Power Supply		1-phase 208/230V 60Hz		1-phase 208/230V 60Hz		
Fan	Type × Quantity		Centrifugal×3	Centrifugal×4	Centrifugal×4	Centrifugal×4
	Driving Mechanism		Direct-driven		Direct-driven	
	Motor Type		BLDC	BLDC	BLDC	BLDC
	Motor Power Input	W	140	160	160	160
	Motor Running Current	A	0.6	0.7	0.7	0.7
	Airflow Rate(H/M/L)	CFM	940/850/695	1180/904/755	1180/1065/855	1180/1065/855
m <sup>3</sup> /h		1600/1445/1183	2000/1600/1282	2000/1813/1452	2000/1813/1452	
Sound Pressure Level (H/M/L)	dB(A)	50/47/43	51/47/42	52/49/45	52/49/45	
Air Filter		PP				
Insulation Material		Foamed polystyrene				
Refrigeration Control Device		EXV				
Protection Device		Fuse				



# DC INVERTER MULTI VRF INDOOR UNIT TECHNICAL SALES GUIDE

## 2.6 Wall Mounted Type Indoor Unit

Model		GMV-N07G/A3A-D(U)	GMV-N09G/A3A-D(U)	GMV-N12G/A3A-D(U)	GMV-N18G/A3A-D(U)	GMV-N24G/A3A-D(U)	
Cooling Capacity	Btu/h	7500	9500	12000	18000	24000	
	kW	2.2	2.8	3.5	5.2	7	
Heating Capacity	Btu/h	8500	11000	13500	20000	25500	
	kW	2.5	3.2	4	5.8	7.5	
Casing Finish		Galvanized Steel plate					
Dimensions (W×D×H)	Outline	mm	843×180×275	843×180×275	940×200×298	940×200×298	1008×221×319
		in.	33-3/16×7-1/16×10-13/16	33-3/16×7-1/16×10-13/16	37×7-7/8×11-3/4	37×7-7/8×11-3/4	37×7-7/8×11-3/4
	Packaging	mm	973×258×370	973×258×370	1068×288×395	1068×288×395	1131×398×328
		in.	38-5/16×10-3/16×14-9/16	38-5/16×10-3/16×14-9/16	42-1/16×11-5/16×15-9/16	42-1/16×11-5/16×15-9/16	42-1/16×11-5/16×15-9/16
Net Weight	lbs.	22.1	22.1	27.6	27.6	33.1	
	kg	10	10	12.5	12.5	15	
Gross Weight	lbs.	27.6	27.6	34.2	34.2	40.8	
	kg	12.5	12.5	15.5	15.5	18.5	
Pipe Connection	Liquid Side	mm	Φ6.35	Φ6.35	Φ6.35	Φ6.35	Φ9.52
		in.	Φ1/4	Φ1/4	Φ1/4	Φ1/4	Φ3/8
	Gas Side	mm	Φ9.52	Φ9.52	Φ12.7	Φ12.7	Φ15.9
		in.	Φ3/8	Φ3/8	Φ1/2	Φ1/2	Φ5/8
	Drain Pipe	mm	Φ20	Φ20	Φ20	Φ20	Φ30
		in.	Φ4/5	Φ4/5	Φ4/5	Φ4/5	Φ11/6
Power Supply		1-phase 208/230V 60Hz					
Fan	Type × Quantity		Cross-flow ×1	Cross-flow ×1	Cross-flow ×1	Cross-flow ×1	Cross-flow ×1
	Driving Mechanism		Direct-driven				
	Motor Type		PG				
	Motor Power Input	W	50	50	60	60	70
	Motor Running Current	A	0.2	0.2	0.21	0.21	0.31
	Airflow Rate (H/M/L)	CFM	295/247/206	295/247/206	370/324/283	370/324/283	440/353/294
m <sup>3</sup> /h		500/420/350	500/420/350	630/550/480	630/550/480	750/600/500	
Sound Pressure Level (H/M/L)	dB(A)	38/34/30	38/34/30	44/41/38	44/41/38	44/41/38	
Heat Exchanger		Fenestrate plain film -- hydrophilic film					
Air Filter		PP+10%BCM+FP03					
Insulation Material		Foamed polystyrene					
Refrigeration Control Device		EXV					
Protection Device		Fuse					

Model		GMV-N07G/E3A-D(U)	GMV-N09G/E3A-D(U)	GMV-N12G/E3A-D(U)	GMV-N18G/E3A-D(U)	GMV-N24G/E3A-D(U)	
Cooling Capacity	Btu/h	7500	9500	12000	18000	24000	
	kW	2.2	2.8	3.5	5.2	7	
Heating Capacity	Btu/h	8500	11000	13500	20000	25500	
	kW	2.5	3.2	4	5.8	7.5	
Casing Finish		Galvanized Steel plate					
Dimensions (W×D×H)	Outline	mm	843×180×275	843×180×275	940×200×298	940×200×298	940×200×298
		in.	33-3/16×7-1/16×10-13/16	33-3/16×7-1/16×10-13/16	37×7-7/8×11-3/4	37×7-7/8×11-3/4	37×7-7/8×11-3/4
	Packaging	mm	973×258×370	973×258×370	1068×288×395	1068×288×395	1068×288×395
		in.	38-5/16×10-3/16×14-9/16	38-5/16×10-3/16×14-9/16	42-1/16×11-5/16×15-9/16	42-1/16×11-5/16×15-9/16	42-1/16×11-5/16×15-9/16
Net Weight	lbs.	22.1	22.1	27.6	27.6	33.1	
	kg	10	10	12.5	12.5	15	
Gross Weight	lbs.	27.6	27.6	34.2	34.2	40.8	
	kg	12.5	12.5	15.5	15.5	18.5	
Pipe Connection	Liquid Side	mm	Φ6.35	Φ6.35	Φ6.35	Φ6.35	Φ9.52
		in.	Φ1/4	Φ1/4	Φ1/4	Φ1/4	Φ3/8
	Gas Side	mm	Φ9.52	Φ9.52	Φ12.7	Φ12.7	Φ15.9
		in.	Φ3/8	Φ3/8	Φ1/2	Φ1/2	Φ5/8
	Drain Pipe	mm	Φ20	Φ20	Φ20	Φ20	Φ30
		in.	Φ4/5	Φ4/5	Φ4/5	Φ4/5	Φ1 1/6
Power Supply		1-phase 208/230V 60Hz					
Fan	Type × Quantity		Cross-flow×1	Cross-flow×1	Cross-flow×1	Cross-flow×1	Cross-flow×1
	Driving Mechanism		Direct-driven				
	Motor Type		PG				
	Motor Power Input	W	50	50	60	60	70
	Motor Running Current	A	0.2	0.2	0.21	0.21	0.31
	Airflow Rate (H/M/L)	CFM	295/247/206	295/247/206	370/324/283	370/324/283	440/353/294
m <sup>3</sup> /h		500/420/350	500/420/350	630/550/480	630/550/480	750/600/500	
Sound Pressure Level (H/M/L)		dB(A)	38/34/30	38/34/30	44/41/38	44/41/38	44/41/38
Heat Exchanger		Fenestrate plain film -- hydrophilic film					
Air Filter		PP+10%BCM+FP03					
Insulation Material		Foamed polystyrene					
Refrigeration Control Device		EXV					
Protection Device		Fuse					

# DC INVERTER MULTI VRF INDOOR UNIT TECHNICAL SALES GUIDE

Model			GMV-ND06G/ B4B-T(U)	GMV-ND07G/ B4B-T(U)	GMV-ND09G/ B4B-T(U)	GMV-ND12G/ B4B-T(U)	GMV-ND14G/ B4B-T(U)
Cooling Capacity	Btu/h		6000	7500	9500	12000	15000
	kW		1.8	2.2	2.8	3.5	4.4
Heating Capacity	Btu/h		6000	8500	10500	13500	17000
	kW		1.8	2.5	3.2	4.0	5.0
Casing Finish			Galvanized Steel plate				
Dimensions (W×D×H)	Outline	mm	845×209×289	845×209×289	845×209×289	845×209×289	970×300×224
		in.	33-1/4×8-1/4×11-3/8	33-1/4×8-1/4×11-3/8	33-1/4×8-1/4×11-3/8	33-1/4×8-1/4×11-3/8	38-3/16×11-13/16×8-13/16
	Packaging	mm	976×281×379	976×281×379	976×281×379	976×281×379	1096×383×320
		in.	38-7/16×11-1/16×14-15/16	38-7/16×11-1/16×14-15/16	38-7/16×11-1/16×14-15/16	38-7/16×11-1/16×14-15/16	43-1/8×15-1/16×12-5/8
Net Weight	lbs.		23.5	23.5	23.5	23.5	27.5
	kg		10.5	10.5	10.5	10.5	12.5
Gross Weight	lbs.		27.5	27.5	27.5	27.5	34.5
	kg		12.5	12.5	12.5	12.5	15.5
Pipe Connections	Liquid Side	mm	Φ6.35	Φ6.35	Φ6.35	Φ6.35	Φ6.35
		in.	Φ1/4	Φ1/4	Φ1/4	Φ1/4	Φ1/4
	Gas Side	mm	Φ9.52	Φ9.52	Φ9.52	Φ12.7	Φ12.7
		in.	Φ3/8	Φ3/8	Φ3/8	Φ1/2	Φ1/2
	Drain Pipe	mm	Φ20	Φ20	Φ20	Φ20	Φ20
		in.	Φ13/16	Φ13/16	Φ13/16	Φ13/16	Φ13/16
Power Supply			1-phase 208/230V 60Hz				
Fan	Type × Quantity		Cross-flow×1	Cross-flow×1	Cross-flow×1	Cross-flow×1	Cross-flow×1
	Driving Mechanism		Direct-driven				
	Motor Type		BLDC				
	Motor Power Input	W	20	20	20	25	35
	Motor Running Current	A	0.1	0.1	0.1	0.12	0.17
	Airflow Rate (H/M/L)	CFM		294/259/177	294/259/177	294/259/177	371/271/188
m <sup>3</sup> /h			500/440/300	500/440/300	500/440/300	630/460/320	850/580/500
Sound Pressure Level (H/M/L)	dB(A)		35/33/30	35/33/30	35/33/30	38/35/31	43/40/37
Heat Exchanger			Fenestrate plain film -- hydrophilic film				
Air Filter			PP+PP MD10				
Insulation Material			Foamed polystyrene				
Refrigeration Control Device			EXV				
Protection Device			Fuse				

Model		GMV-ND18G/B4B-T(U)	GMV-ND24G/B4B-T(U)	GMV-ND30G/B4B-T(U)	GMV-ND36G/B4B-T(U)	
Cooling Capacity	Btu/h	18000	24000	30000	32500	
	kW	5.2	7.0	8.8	9.5	
Heating Capacity	Btu/h	20000	25500	34000	36000	
	kW	5.8	7.5	10.0	10.5	
Casing Finish		Galvanized Steel plate				
Dimensions (W×D×H)	Outline	mm	1078×325×246	1078×325×246	1350×258×326	1350×258×326
		in.	42-7/16×12-13/16×9-11/16	42-7/16×12-13/16×9-11/16	53-1/8×10-3/16×12-13/16	53-1/8×10-3/16×12-13/16
	Packaging	mm	1203×413×350	1203×413×350	1496×421×369	1496×421×369
		in.	47-3/8×16-1/4×13-3/4	47-3/8×16-1/4×13-3/4	58-7/8×16-9/16×14-1/2	58-7/8×16-9/16×14-1/2
Net Weight	lbs.	35.5	35.5	41	41	
	kg	16	16	18.5	18.5	
Gross Weight	lbs.	42	42	52	52	
	kg	19	19	23.5	23.5	
Pipe Connections	Liquid Side	mm	Φ9.52	Φ9.52	Φ9.52	Φ9.52
		in.	Φ3/8	Φ3/8	Φ3/8	Φ3/8
	Gas Side	mm	Φ15.9	Φ15.9	Φ15.9	Φ15.9
		in.	Φ5/8	Φ5/8	Φ5/8	Φ5/8
	Drain Pipe	mm	Φ20	Φ20	Φ20	Φ20
		in.	Φ13/16	Φ13/16	Φ13/16	Φ13/16
Power Supply		1-phase 208/230V 60Hz				
Fan	Type × Quantity		Cross-flow×1	Cross-flow×1	Cross-flow×1	Cross-flow×1
	Driving Mechanism		Direct-driven			
	Motor Type		BLDC			
	Motor Power Input	W	50	65	80	100
	Motor Running Current	A	0.24	0.31	0.41	0.41
	Airflow Rate(H/M/L)	CFM	647/500/383	706/500/383	912/618/471	971/647/530
m <sup>3</sup> /h		1100/850/650	1200/850/650	1550/1050/800	1650/1100/900	
Sound Pressure Level (H/M/L)	dB(A)	43/41/37	44/41/37	49/46/40	52/48/40	
Heat Exchanger		Fenestrate plain film -- hydrophilic film				
Air Filter		PP+PP MD10				
Insulation Material		Foamed polystyrene				
Refrigeration Control Device		EXV				
Protection Device		Fuse				

# DC INVERTER MULTI VRF INDOOR UNIT TECHNICAL SALES GUIDE

## 2.7 Fresh Air Processing Unit

Model			GMV-NDX42P/A-T(U)	GMV-NDX48P/A-T(U)	GMV-NDX54P/A-T(U)		
Cooling Capacity	Btu/h		42000	48000	54000		
	kW		12.3	14.1	15.8		
Heating Capacity <sup>*1</sup>	Btu/h		29000	34000	45000		
	kW		8.5	10.0	13.2		
Heating Capacity <sup>*2</sup>	Btu/h		36000	41000	52000		
	kW		10.5	12.0	15.2		
Casing Finish			Galvanized Steel plate				
Dimensions (W×D×H)	Outline	mm	1400×700×300	1400×700×300	1483×791×385		
		in.	55-1/8×27-9/16×11-3/16	55-1/8×27-9/16×11-3/16	58-3/8×31-1/8×15-3/16		
	Packaging	mm	1601×813×365	1601×813×365	1578×883×472		
		in.	63×32×14 3/8	63×32×14 3/8	62-1/8×34-3/4×18-5/8		
Net Weight		lbs.	119	119	181		
		kg	54	54	82		
Gross Weight		lbs.	134	134	229		
		kg	61	61	104		
Pipe Connection		Liquid Side	mm	Φ9.52	Φ9.52	Φ9.52	
			in.	Φ3/8	Φ3/8	Φ3/8	
		Gas Side	mm	Φ15.9	Φ15.9	Φ19.05	
			in.	Φ5/8	Φ5/8	Φ3/4	
		Drain Pipe	mm	Φ25	Φ25	Φ25	
			in.	Φ1	Φ1	Φ1	
Power Supply			1-phase 208/230V 60Hz				
Fan	Type × Quantity		Centrifugal×3	Centrifugal×3	Centrifugal×2		
	Driving Mechanism		Direct-driven				
	Motor Type		BLDC				
	Motor Power Input	W	350	350	760		
	Motor Running Current	A	2.0	2.0	4.3		
	Airflow Rate(H/M/L)		CFM	706/589~1177	706/589~1177	1177/883~1766	
			m <sup>3</sup> /h	1200/1000~2000	1200/1000~2000	2000/1500~3000	
	External Static Pressure		Default	in.W.G	0.60	0.60	0.80
				Pa	150	150	200
			Range	in.W.G	0.20~0.80	0.20~0.80	0.20~1.20
Pa				50~200	50~200	50~300	
Sound Pressure Level(H/M/L)		dB(A)	40~50	40~50	45~54		
Heat Exchanger			/				
Air Filter			PP				
Insulation Material			Foamed polystyrene				
Refrigeration Control Device			EXV				
Protection Device			Fuse				

Model			GMV-NDX72P/A-T(U)	GMV-NDX96P/A-T(U)	
Cooling Capacity	Btu/h		72000	96000	
	kW		21.1	28.1	
Heating Capacity <sup>*1</sup>	Btu/h		55000	68000	
	kW		16.1	20.0	
Heating Capacity <sup>*2</sup>	Btu/h		68000	75000	
	kW		20.0	22.0	
Casing Finish			Galvanized Steel plate		
Dimensions (W×D×H)	Outline	mm	1483×791×385	1483×791×385	
		in.	58-3/8×31-1/8×15-3/16	58-3/8×31-1/8×15-3/16	
	Packaging	mm	1578×883×472	1578×883×472	
		in.	62-1/8×34-3/4×18-5/8	62-1/8×34-3/4×18-5/8	
Net Weight		lbs.	181	181	
		kg	82	82	
Gross Weight		lbs.	229	229	
		kg	104	104	
Pipe Connection	Liquid Side	mm	Φ9.52	Φ9.52	
		in.	Φ3/8	Φ3/8	
	Gas Side	mm	Φ19.05	Φ22.2	
		in.	Φ3/4	Φ7/8	
	Drain Pipe	mm	Φ25	Φ25	
		in.	Φ1	Φ1	
Power supply			1-phase 208/230V 60Hz		
Fan	Type × Quantity		Centrifugal×2	Centrifugal×2	
	Driving Mechanism		Direct-driven		
	Motor Type		BLDC		
	Motor Power Input	W	750	750	
	Motor Running Current	A	4.3	4.9	
	Airflow Rate (H/M/L)		CFM	1177/883~1766	1471/1177~2060
			m <sup>3</sup> /h	2000/1500~3000	2500/2000~3500
	External Static Pressure		Default	in.W.G	0.80
				Pa	200
			Range	in.W.G	0.20~1.20
Pa				50~300	
Sound Pressure Level(H/M/L)		dB(A)	45~54	47~54	
Heat Exchanger			/		
Air Filter			PP		
Insulation Material			Foamed polystyrene		
Refrigeration Control Device			EXV		
Protection Device			Fuse		

**NOTICE!**

- ① Rated cooling capacity test conditions: indoor 95.0°FDB/82.4°F WB, outdoor 95.0°FDB; connection pipe length: 24-5/8ft., without height drop between units. The default air outlet temperature of the unit is 64.4°F.
- ② Rated heating capacity test conditions: ×1. indoor 44.6°FDB, outdoor 44.6°FDB/42.8 °F WB, ×2 indoor 32°FDB, outdoor 32°FDB/26.8°F WB, connection pipe length: 24-5/8ft., without height drop between units. The default air outlet temperature of the unit is 71.6°F.

③ The Sound Pressure Level will change with the External Static Pressure.

④ This series can be matched with GMV5 only.

According to the different selected air volume, there are two kinds of connection method for the VRF fresh air series indoor unit:

(1) If the selected air volume  $\leq 1471\text{CFM}(2500\text{m}^3/\text{h})$ , connect with normal indoor units by blow method, or connect with the fixed outdoor unit as shown in (2).

Model of Indoor Unit	Model of Outdoor Unit
GMV-NDX42P/A-T(U)	The total capacity of connected fresh air series indoor units and conventional VRF indoor units must be within 50%~100% of the capacity of outdoor unit, among which, the total capacity of connected fresh air indoor units cannot exceed 30% of the capacity of outdoor unit. Fresh air indoor units can operate independently. The total capacity of connected fresh air indoor units cannot exceed 50%~100% of the capacity of outdoor unit.
GMV-NDX48P/A-T(U)	
GMV-NDX54P/A-T(U)	
GMV-NDX72P/A-T(U)	
GMV-NDX96P/A-T(U)	

**NOTICE!**

When fresh air series indoor units and conventional VRF indoor units will be connected, please follow the capacity requirement strictly. The total capacity of connected fresh air indoor units cannot exceed 30% of the capacity of outdoor unit, while the total capacity of indoor units shall be within 50%~100% of the capacity of outdoor unit. Otherwise, the comfortableness will be affected or even the unit will be damaged.

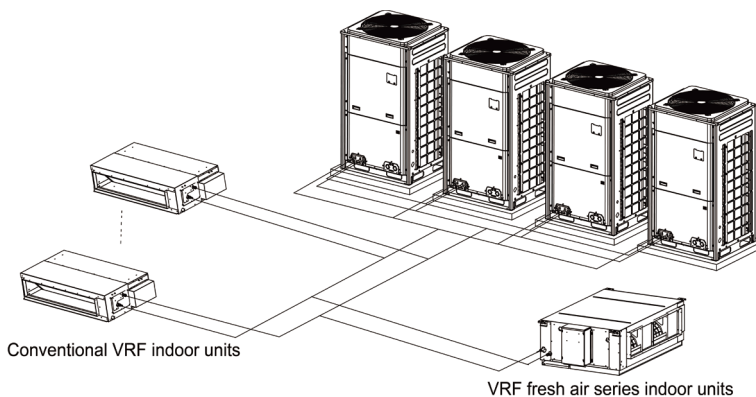

(2) If the selected air volume  $> 1471\text{CFM}(2500\text{m}^3/\text{h})$ , it can only connect the fixed outdoor unit as below:

Model of Indoor Unit	Model of Outdoor Unit
GMV-NDX54P/A-T(U)	GMV-72WM/B-F(U)
GMV-NDX72P/A-T(U)	GMV-72WM/B-F(U)
GMV-NDX96P/A-T(U)	GMV-72WM/B-F(U)

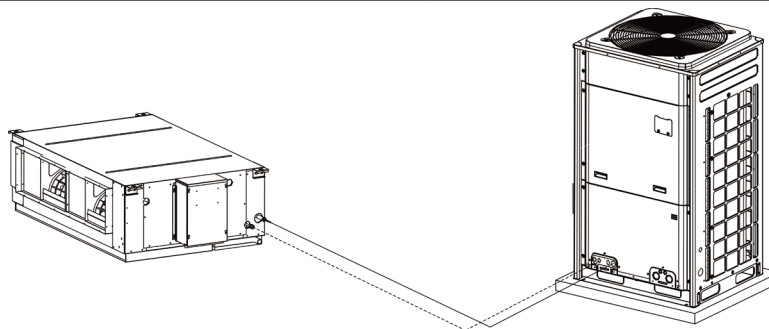

(3) For example:

- 1) Customer select GMV-NDX96P/A-T(U) model. After the unit is installed, the fan static pressure is 0.8 in.W.G(200Pa). The required air volume by the customer is 1766CFM(3000m<sup>3</sup>/h), the corresponding static notch on the curve diagram between air volume and static pressure is notch 09. Because the air volume is more than 1471CFM(2500m<sup>3</sup>/h), it needs to adopt the second fixed connection method, matching GMV-96WM/B-F(U).
- 2) Customer select GMV-NDX72P/A-T(U) model. After the unit is installed, the fan static pressure is 0.6 in.W.G(150Pa). The required air volume by the customer is 1354CFM(2300m<sup>3</sup>/h), the corresponding static notch on the curve diagram between air volume and static pressure is notch 05. Because the air volume is less than 1471CFM(2500m<sup>3</sup>/h), it can adopt first connection method or the second fixed connection method by matching GMV-72WM/B-F(U).

## 2.8 Console Type

Model			GMV-ND07C/A-T(U)	GMV-ND09C/A-T(U)	GMV-ND12C/A-T(U)	GMV-ND18C/A-T(U)
Cooling Capacity	Btu/h		7500	9500	12000	18000
	kW		2.2	2.8	3.5	5.3
Heating Capacity	Btu/h		8500	11000	13500	20000
	kW		2.5	3.2	4	5.8
Casing Finish			Galvanized Steel plate			
Dimensions (W×D×H)	Outline	mm	700×215×600	700×215×600	700×215×600	700×215×600
		in.	27-9/16×8-1/2×23-5/8	27-9/16×8-1/2×23-5/8	27-9/16×8-1/2×23-5/8	27-9/16×8-1/2×23-5/8
	Packaging	mm	785×280×762	785×280×762	785×280×762	785×280×762
		in.	31×15-2/5×11-3/5	31×15-2/5×11-3/5	31×15-2/5×11-3/5	31×15-2/5×11-3/5
Net Weight	lbs.		35	35	35	35
	kg		16	16	16	16
Gross Weight	lbs.		42	42	42	42
	kg		19	19	19	19
Pipe Connections	Liquid Side	mm	Φ6.35	Φ6.35	Φ6.35	Φ6.35
		in.	Φ1/4	Φ1/4	Φ1/4	Φ1/4
	Gas Side	mm	Φ9.52	Φ9.52	Φ12.7	Φ12.7
		in.	Φ3/8	Φ3/8	Φ1/2	Φ1/2
	Drain Pipe	mm	Φ28	Φ28	Φ28	Φ28
		in.	Φ1-1/9	Φ1-1/9	Φ1-1/9	Φ1-1/9
Power Supply			1-phase 208/230V 60Hz			
Fan	Type × Quantity		Centrifugal×1	Centrifugal×1	Centrifugal×1	Centrifugal×1
	Driving Mechanism		Direct-driven			
	Motor Type		BLDC			
	Motor Power Input	W	38	38	38	38
	Motor Running Current	A	0.4	0.4	0.4	0.4
	Airflow Rate (H/M/L)	CFM		235	235	282
m <sup>3</sup> /h			400	400	480	680
Sound Pressure Level(H/M/L)		dB(A)	38	38	40	46
Heat Exchanger			Fenestrate plain film -- hydrophilic film			
Air Filter			PP			
Insulation Material			Foamed polystyrene			
Refrigeration Control Device			EXV			
Protection Device			Fuse			



# DC INVERTER MULTI VRF INDOOR UNIT TECHNICAL SALES GUIDE

## 2.9 Two-way Cassette Type

Model		GMV-ND09TS/ A-T(U)	GMV-ND12TS/ A-T(U)	GMV-ND15TS/ A-T(U)	GMV-ND18TS/ A-T(U)	GMV-ND24TS/ A-T(U)	
Cooling Capacity	Btu/h	9500	12000	15000	18000	24000	
	kW	2.8	3.5	4.4	5.3	7	
Heating Capacity	Btu/h	10500	13500	17000	20000	27000	
	kW	3.1	4.0	5	5.9	7.9	
Casing Finish		Galvanized Steel plate					
Dimensions (W×D×H)	Body Outline	mm	1200×520×340	1200×520×340	1200×520×340	1200×520×340	1200×520×340
		in.	47-1/4×20-1/2×13-3/8	47-1/4×20-1/2×13-3/8	47-1/4×20-1/2×13-3/8	47-1/4×20-1/2×13-3/8	47-1/4×20-1/2×13-3/8
	Body Packaging	mm	1523×658×430	1523×658×430	1523×658×430	1523×658×430	1523×658×430
		in.	60×26×17	60×26×17	60×26×17	60×26×17	60×26×17
	Panel Outline	mm	1443×630×33	1443×630×33	1443×630×33	1443×630×33	1443×630×33
		in.	55-3/4×24-13/16×1-1/4	55-3/4×24-13/16×1-1/4	55-3/4×24-13/16×1-1/4	55-3/4×24-13/16×1-1/4	55-3/4×24-13/16×1-1/4
Panel Packaging	mm	1578×658×120	1578×658×120	1578×658×120	1578×658×120	1578×658×120	
	in.	62-1/8×30-1/4×4-11/16	62-1/8×30-1/4×4-11/16	62-1/8×30-1/4×4-11/16	62-1/8×30-1/4×4-11/16	62-1/8×30-1/4×4-11/16	
Net Weight	Body	lbs.	95	95	95	95	101
		kg	43	43	43	43	46
	Panel	lbs.	15	15	15	15	15
		kg	7	7	7	7	7
Gross Weight	Body	lbs.	119	119	119	119	123
		kg	54	54	54	54	56
	Panel	lbs.	24	24	24	24	24
		kg	11	11	11	11	11
Pipe Connection	Liquid Side	mm	Φ6.35	Φ6.35	Φ6.35	Φ9.52	Φ9.52
		in.	Φ1/4	Φ1/4	Φ1/4	Φ3/8	Φ3/8
	Gas Side	mm	Φ9.52	Φ12.7	Φ12.7	Φ15.9	Φ15.9
		in.	Φ3/8	Φ1/2	Φ1/2	Φ5/8	Φ5/8
	Drain Pipe	mm	Φ25	Φ25	Φ25	Φ25	Φ25
		in.	Φ1	Φ1	Φ1	Φ1	Φ1
Power Supply		1-phase 208/230V 60Hz			1-phase 208/230V 60Hz		
Fan	Type × Quantity		Centrifugal×3	Centrifugal×3	Centrifugal×3	Centrifugal×3	Centrifugal×3
	Driving Mechanism		Direct-driven				
	Motor Type		BLDC				
	Motor Power Input	W	55	55	55	55	91
	Motor Running Current	A	0.4	0.4	0.4	0.4	0.7
	Airflow Rate (H/M/L)	CFM	490/355/312	490/355/312	490/355/312	490/355/312	650/483/448
m <sup>3</sup> /h		830/600/530	830/600/530	830/600/530	830/600/530	1100/820/760	
Sound Pressure Level (H/M/L)		dB(A)	35/33/31	35/33/31	35/33/31	35/33/31	39/37/35
Heat Exchanger		/					
Air Filter		PP					
Insulation Material		Foamed polystyrene					
Refrigeration Control Device		EXV					
Protection Device		Fuse					
Panel Name		TE01					

## 2.10 Compact Four-way Cassette Type

Model		GMV-ND07T/B-T(U)	GMV-ND09T/B-T(U)	GMV-ND12T/B-T(U)	GMV-ND15T/B-T(U)	GMV-ND18T/B-T(U)	
Cooling Capacity	Btu/h	7500	9500	12000	15000	18000	
	kW	2.2	2.8	3.5	4.4	5.3	
Heating Capacity	Btu/h	8500	10500	13500	17000	20000	
	kW	2.5	3.1	4.0	5.0	5.9	
Casing Finish		Galvanized Steel plate					
Dimensions(W×D×H)	Body Outline	mm	596×596×240	596×596×240	596×596×240	596×596×240	596×596×240
		in.	23-1/2×23-1/2×9-1/2	23-1/2×23-1/2×9-1/2	23-1/2×23-1/2×9-1/2	23-1/2×23-1/2×9-1/2	23-1/2×23-1/2×9-1/2
	Body Packaging	mm	778×738×300	778×738×300	778×738×300	778×738×300	778×738×300
		in.	30-5/8×29×11-3/4	30-5/8×29×11-3/4	30-5/8×29×11-3/4	30-5/8×29×11-3/4	30-5/8×29×11-3/4
	Panel Outline	mm	670×670×50	670×670×50	670×670×50	670×670×50	670×670×50
		in.	26-3/8×26-3/8×2	26-3/8×26-3/8×2	26-3/8×26-3/8×2	26-3/8×26-3/8×2	26-3/8×26-3/8×2
	Panel Packaging	mm	763×763×105	763×763×105	763×763×105	763×763×105	763×763×105
		in.	30×30×4-1/8	30×30×4-1/8	30×30×4-1/8	30×30×4-1/8	30×30×4-1/8
Net Weigh	Main Body	lbs.	45	45	45	45	45
		kg	20.5	20.5	20.5	20.5	20.5
	Panel	lbs.	8	8	8	8	8
		kg	3.5	3.5	3.5	3.5	3.5
Gross Weigh	Main Body	lbs.	56	56	56	56	56
		kg	25.5	25.5	25.5	25.5	25.5
	Panel	lbs.	11	11	11	11	11
		kg	5	5	5	5	5
Pipe Connections	Liquid Side	mm	Φ6.35	Φ6.35	Φ6.35	Φ6.35	Φ9.52
		in.	Φ1/4	Φ1/4	Φ1/4	Φ1/4	Φ3/8
	Gas Side	mm	Φ9.52	Φ9.52	Φ12.7	Φ12.7	Φ15.9
		in.	Φ3/8	Φ3/8	Φ1/2	Φ1/2	Φ5/8
	Drain Pipe	mm	Φ25	Φ25	Φ25	Φ25	Φ25
		in.	Φ1	Φ1	Φ1	Φ1	Φ1
Power Supply		1-phase 208/230V 60Hz					
Fan	Type × Quantity		Centrifugal×1	Centrifugal×1	Centrifugal×1	Centrifugal×1	Centrifugal×1
	Driving Mechanism		Direct-driven	Direct-driven	Direct-driven	Direct-driven	Direct-driven
	Motor Type		BLDC	BLDC	BLDC	BLDC	BLDC
	Motor Power Input	W	35	35	35	45	45
	Motor Running Current	A	0.4	0.4	0.4	0.5	0.5
	Airflow Rate (H/M/L)	CFM	355/295/235	355/295/235	355/295/235	410/355/283	410/355/283
Sound Pressure Level(H/M/L)	m <sup>3</sup> /h	600/500/400	600/500/400	600/500/400	700/600/480	700/600/480	
Sound Pressure Level(H/M/L)	dB(A)	41/39/35	41/39/35	41/39/35	45/43/38	45/43/38	
Heat Exchanger		Fenestrate plain film --hydrophilic film					
Air Filter		PP					
Insulation Material		Foamed polystyrene					
Refrigeration Control Device		EXV					
Protection Device		Fuse					
Panel Name		TC03					

# DC INVERTER MULTI VRF INDOOR UNIT TECHNICAL SALES GUIDE

## 2.11 Super High Static Pressure Duct Type Indoor Unit

Model		GMV-ND07PHS/B-T(U)	GMV-ND09PHS/B-T(U)	GMV-ND12PHS/B-T(U)	GMV-ND15PHS/B-T(U)		
Cooling Capacity	Btu/h	7500	9500	12000	15000		
	kW	2.2	2.8	3.5	4.4		
Heating Capacity	Btu/h	8500	10500	13500	17000		
	kW	2.5	3.1	4	5		
Casing Finish		Galvanized Steel plate					
Dimensions (W×D×H)	Outline	mm	700×700×300	700×700×300	1000×700×300	1000×700×300	
		in.	27-9/16×27-9/16×11-13/16	27-9/16×27-9/16×11-13/16	39-3/8×27-9/16×11-13/16	39-3/8×27-9/16×11-13/16	
	Packaging	mm	897×808×360	897×808×360	1205×813×360	1205×813×360	
		in.	35-5/16×32x14-3/16	35-5/16×32x14-3/16	47-7/16×32x14-3/16	47-7/16×32x14-3/16	
Net Weight	lbs.	73	73	94	94		
	kg	33	33	42.6	42.6		
Gross Weight	lbs.	86	86	108	108		
	kg	39	39	49	49		
Pipe Connections	Liquid Side	mm	Φ6.35	Φ6.35	Φ6.35	Φ6.35	
		in.	Φ1/4	Φ1/4	Φ1/4	Φ1/4	
	Gas Side	mm	Φ9.52	Φ9.52	Φ12.7	Φ12.7	
		in.	Φ3/8	Φ3/8	Φ1/2	Φ1/2	
	Drain Pipe	mm	Φ25	Φ25	Φ25	Φ25	
		in.	Φ1	Φ1	Φ1	Φ1	
Power Supply		1-phase 208/230V 60Hz					
Fan	Type × Quantity		Centrifugal×1	Centrifugal×1	Centrifugal×2	Centrifugal×2	
	Driving Mechanism		Direct-driven	Direct-driven	Direct-driven	Direct-driven	
	Motor Type		BLDC	BLDC	BLDC	BLDC	
	Motor Power Input	W	/	/	/	/	
	Motor Running Current	A	0.3	0.3	0.3	0.3	
	Airflow Rate (H/M/L)	CFM	324/282/235	324/282/235	353/294/247	500/412/353	
		m <sup>3</sup> /h	550/480/400	550/480/400	600/500/420	850/700/600	
	External Static Pressure	Default	in.W.G	0.24	0.24	0.24	0.24
			Pa	60	60	60	60
		Range	in.W.G	0~0.6	0~0.6	0~0.6	0~0.6
Pa			0~150	0~150	0~150	0~150	
Sound Pressure Level(H/M/L)	dB(A)	35/33/31	35/33/31	36/34/32	40/37/34		
Heat Exchanger		Fenestrate plain film -- hydrophilic film					
Air Filter		PP	PP	PP	PP		
Insulation Material		Foamed polystyrene					
Refrigeration Control Device		EXV	EXV	EXV	EXV		
Protection Device		Fuse	Fuse	Fuse	Fuse		

Model			GMV-ND18PHS/ B-T(U)	GMV-ND22PHS/ B-T(U)	GMV-ND24PHS/ B-T(U)	GMV-ND30PHS/ B-T(U)	
Cooling Capacity	Btu/h		18000	22000	24000	30000	
	kW		5.3	6.4	7	8.8	
Heating Capacity	Btu/h		20000	24000	27000	34000	
	kW		5.9	7	7.9	10	
Casing Finish			Galvanized Steel plate				
Dimensions (W×D×H)	Outline	mm	1000×700×300	1000×700×300	1000×700×300	1400×700×300	
		in.	39-3/8×27-9/16×11-13/16	39-3/8×27-9/16×11-13/16	39-3/8×27-9/16×11-13/16	55-1/8×27-9/16×11-13/16	
	Packaging	mm	1205×813×360	1205×813×360	1205×813×360	1601×813×365	
		in.	47-7/16×32×14-3/16	47-7/16×32×14-3/16	47-7/16×32×14-3/16	63-1/16×32×14-3/8	
Net Weight	lbs.		94	94	94	121	
	kg		42.6	42.6	42.6	55	
Gross Weight	lbs.		108	108	108	137	
	kg		49	49	49	62	
Pipe Connections	Liquid Side	mm	Φ9.52	Φ9.52	Φ9.52	Φ9.52	
		in.	Φ3/8	Φ3/8	Φ3/8	Φ3/8	
	Gas Side	mm	Φ15.9	Φ15.9	Φ15.9	Φ15.9	
		in.	Φ5/8	Φ5/8	Φ5/8	Φ5/8	
	Drain Pipe	mm	Φ25	Φ25	Φ25	Φ25	
		in.	Φ1	Φ1	Φ1	Φ1	
Power Supply			1-phase 208/230V 60Hz				
Fan	Type × Quantity		Centrifugal×2	Centrifugal×2	Centrifugal×2	Centrifugal×3	
	Driving Mechanism		Direct-driven	Direct-driven	Direct-driven	Direct-driven	
	Motor Type		BLDC	BLDC	BLDC	BLDC	
	Motor Power Input	W	/	/	/	/	
	Motor Running Current	A	0.7	0.7	0.9	1.2	
	Airflow Rate (H/M/L)	CFM	589/471/412	589/471/412	736/618/559	1059/853/736	
		m <sup>3</sup> /h	1000/800/700	1000/800/700	1250/1050/950	1800/1450/1250	
	External Static Pressure	Default	in.W.G	0.36	0.36	0.36	0.36
			Pa	90	90	90	90
		Range	in.W.G	0~0.8	0~0.8	0~0.8	0~0.8
Pa			0~200	0~200	0~200	0~200	
Sound Pressure Level(H/M/L)		dB(A)	42/38/35	42/38/35	43/39/35	44/41/38	
Heat Exchanger			Fenestrate plain film -- hydrophilic film				
Air Filter			PP	PP	PP	PP	
Insulation Material			Foamed polystyrene				
Refrigeration Control Device			EXV	EXV	EXV	EXV	
Protection Device			Fuse	Fuse	Fuse	Fuse	

# DC INVERTER MULTI VRF INDOOR UNIT TECHNICAL SALES GUIDE

Model		GMV-ND36PHS/ B-T(U)	GMV-ND42PHS/ B-T(U)	GMV-ND48PHS/ B-T(U)	GMV-ND54PHS/ B-T(U)		
Cooling Capacity	Btu/h	36000	42000	48000	54000		
	kW	10.6	12.3	14.1	15.8		
Heating Capacity	Btu/h	40000	47000	54000	60000		
	kW	11.7	13.8	15	17.6		
Casing Finish		Galvanized Steel plate					
Dimensions (W×D×H)	Outline	mm	1400×700×300	1400×700×300	1400×700×300	1400×700×300	
		in.	55-1/8×27-9/16×11-13/16	55-1/8×27-9/16×11-13/16	55-1/8×27-9/16×11-13/16	55-1/8×27-9/16×11-13/16	
	Packaging	mm	1601×813×365	1601×813×365	1678×808×365	1678×808×365	
		in.	63-1/16×32×14-3/8	63-1/16×32×14-3/8	66-1/16×32×14-3/8	66-1/16×32×14-3/8	
Net Weight	lbs.	121	121	128	128		
	kg	55	55	58	58		
Gross Weight	lbs.	137	137	148	148		
	kg	62	62	67	67		
Pipe Connections	Liquid Side	mm	Φ9.52	Φ9.52	Φ9.52	Φ9.52	
		in.	Φ3/8	Φ3/8	Φ3/8	Φ3/8	
	Gas Side	mm	Φ15.9	Φ15.9	Φ15.9	Φ19.05	
		in.	Φ5/8	Φ5/8	Φ5/8	Φ3/4	
	Drain Pipe	mm	Φ25	Φ25	Φ25	Φ25	
		in.	Φ1	Φ1	Φ1	Φ1	
Power Supply		1-phase 208/230V 60Hz					
Fan	Type × Quantity		Centrifugal×3	Centrifugal×3	Centrifugal×3	Centrifugal×3	
	Driving Mechanism		Direct-driven	Direct-driven	Direct-driven	Direct-driven	
	Motor Type		BLDC	BLDC	BLDC	BLDC	
	Motor Power Input	W	/	/	/	/	
	Motor Running Current	A	1.2	1.2	1.3	1.3	
	Airflow Rate (H/M/L)	CFM	1177/942/824	1177/942/824	1383/1118/971	1471/1177/1030	
		m <sup>3</sup> /h	2000/1600/1400	2000/1600/1400	2350/1900/1650	2500/2000/1750	
	External Static Pressure	Default	in.W.G	0.36	0.36	0.36	0.36
			Pa	90	90	90	90
		Range	in.W.G	0~0.8	0~0.8	0~0.8	0~0.8
Pa			0~200	0~200	0~200	0~200	
Sound Pressure Level(H/M/L)	dB(A)	45/42/40	45/42/40	46/43/41	47/44/42		
Heat Exchanger		Fenestrate plain film -- hydrophilic film					
Air Filter		PP	PP	PP	PP		
Insulation Material		Foamed polystyrene					
Refrigeration Control Device		EXV	EXV	EXV	EXV		
Protection Device		Fuse	Fuse	Fuse	Fuse		

Model			GMV-ND72PH/B-T(U)	GMV-ND96PH/B-T(U)	
Cooling Capacity	Btu/h		72000	96000	
	kW		21.1	28.1	
Heating Capacity	Btu/h		81000	108000	
	kW		23.7	31.7	
Casing Finish			Galvanized Steel plate		
Dimensions (W×D×H)	Outline	mm	1240X1040X470	1240X1040X470	
		in.	48-3/4×41×18-1/2	48-3/4×41×18-1/2	
	Packaging	mm	1520x1153X605	1520x1153X605	
		in.	59-7/8×45-3/8×23-7/8	59-7/8×45-3/8×23-7/8	
	Net Weight	lbs.	223	236	
		kg	101	107	
Gross Weight	lbs.	331	340		
	kg	150	154		
Pipe Connections	Liquid Side	mm	Φ9.52	Φ9.52	
		in.	Φ3/8	Φ3/8	
	Gas Side	mm	Φ19.05	Φ22.2	
		in.	Φ3/4	Φ7/8	
	Drain Pipe	mm	Φ25	Φ25	
		in.	Φ1	Φ1	
	Power Supply			1-phase 208/230V 60Hz	
	Fan	Type × Quantity		Centrifugal×2	Centrifugal×2
Driving Mechanism		Direct-driven	Direct-driven		
Motor Type		BLDC	BLDC		
Motor Power Input		W	750	750	
Motor Running Current		A	4.5	5.4	
Airflow Rate(H/M/L)		CFM	2355/1885/1650	2530/2120/1885	
		m <sup>3</sup> /h	4000/3200/2800	4300/3600/3200	
External Static Pressure		Default	in.W.G	0.52	0.6
			Pa	130	150
		Range	in.W.G	0.2~0.98	0.2~1.1
			Pa	50~245	50~275
Sound Pressure Level(H/M/L)		dB(A)	46/45/44	48/46/45	
Heat Exchanger			Fenestrate plain film -- hydrophilic film		
Air Filter			PP	PP	
Insulation Material			Foamed polystyrene		
Refrigeration Control Device			EXV	EXV	
Protection Device			Fuse	Fuse	

## ➔ 2.12 Air Handler Type Indoor Unit

Model			GMV-ND09A/A-T(U)	GMV-ND12A/A-T(U)	GMV-ND18A/A-T(U)	
Cooling Capacity	Btu/h		9500	12000	18000	
	kW		2.8	3.5	5.3	
Heating Capacity	Btu/h		10500	13500	20000	
	kW		3.1	4.0	5.9	
Casing Finish			Galvanized Steel plate			
Dimensions (W×D×H)	Outline	mm	460×540×1105	460×540×1105	460×540×1105	
		in.	18-1/8×21-1/4×43-1/2	18-1/8×21-1/4×43-1/2	18-1/8×21-1/4×43-1/2	
	Packaging	mm	517×620×1170	517×620×1170	517×620×1170	
		in.	20-3/8×24-3/8×46-1/8	20-3/8×24-3/8×46-1/8	20-3/8×24-3/8×46-1/8	
Net Weight	lbs.		119	119	124	
	kg		54	54	56	
Gross Weight	lbs.		128	128	135	
	kg		58	58	61	
Pipe Connections	Liquid Side	mm	Φ6.35	Φ6.35	Φ9.52	
		in.	Φ1/4	Φ1/4	Φ3/8	
	Gas Side	mm	Φ9.52	Φ12.7	Φ15.9	
		in.	Φ3/8	Φ1/2	Φ5/8	
Drain Pipe	/	G1	G1	G1		
Power Supply			1-phase 208/230V 60Hz			
Fan	Type × Quantity		Centrifugal×1	Centrifugal×1	Centrifugal×1	
	Driving Mechanism		Direct-driven	Direct-driven	Direct-driven	
	Motor Type		BLDC	BLDC	BLDC	
	Motor Power Input	W	55.0	55.0	122.5	
	Motor Running Current	A	1.1	1.1	1.1	
	Airflow Rate (H/M/L)	CFM		559/383/324	559/383/324	824/706/559
		m <sup>3</sup> /h		950/650/550	950/650/550	1400/1200/950
	External Static Pressure	Default	in.W.G	0.1	0.1	0.1
Pa			25	25	25	
Range		in.W.G	0~0.3	0~0.3	0~0.3	
		Pa	0~75	0~75	0~75	
Sound Pressure Level(H/M/L)	dB(A)		36/34/32	36/34/32	45/43/41	
Heat Exchanger			Fenestrate plain film -- hydrophilic film			
Air Filter			PP	PP	PP	
Insulation Material			Foamed polystyrene			
Refrigeration Control Device			EXV	EXV	EXV	
Protection Device			Fuse	Fuse	Fuse	

Model			GMV-ND24A/A-T(U)	GMV-ND30A/A-T(U)	GMV-ND36A/A-T(U)	GMV-ND42A/A-T(U)	
Cooling Capacity	Btu/h		24000	30000	36000	42000	
	kW		7.0	8.8	10.6	12.3	
Heating Capacity	Btu/h		27000	34000	40000	47000	
	kW		7.9	10.0	11.7	13.8	
Casing Finish			Galvanized Steel plate				
Dimensions (W×D×H)	Outline	mm	460×540×1105	460×540×1105	540×540×1224	540×540×1224	
		in.	18-1/8×21-1/4×43-1/2	18-1/8×21-1/4×43-1/2	21-1/4×21-1/4×48-1/4	21-1/4×21-1/4×48-1/4	
	Packaging	mm	517×620×1170	517×620×1170	597×620×1289	597×620×1289	
		in.	20-3/8×24-3/8×46-1/8	20-3/8×24-3/8×46-1/8	23-1/2×24-3/8×50-3/4	23-1/2×24-3/8×50-3/4	
Net Weight	lbs.		124	124	148	148	
	kg		56	56	67	67	
Gross Weight	lbs.		135	135	159	159	
	kg		61	61	72	72	
Pipe Connections	Liquid Side	mm	Φ9.52	Φ9.52	Φ9.52	Φ9.52	
		in.	Φ3/8	Φ3/8	Φ3/8	Φ3/8	
	Gas Side	mm	Φ15.9	Φ15.9	Φ15.9	Φ15.9	
		in.	Φ5/8	Φ5/8	Φ5/8	Φ5/8	
Drain Pipe	/	G1	G1	G1	G1		
Power Supply			1-phase 208/230V 60Hz				
Fan	Type × Quantity		Centrifugal×1	Centrifugal×1	Centrifugal×1	Centrifugal×1	
	Driving Mechanism		Direct-driven	Direct-driven	Direct-driven	Direct-driven	
	Motor Type		BLDC	BLDC	BLDC	BLDC	
	Motor Power Input	W	122.5	183.7	294	367.5	
	Motor Running Current	A	1.1	1.4	2.6	2.7	
	Airflow Rate (H/M/L)	CFM		824/706/559	882/706/559	1353/1176/1000	1441/1265/1118
		m <sup>3</sup> /h		1400/1200/950	1500/1200/950	2300/2000/1700	2450/2150/1900
	External Static Pressure	Default	in.W.G	0.1	0.15	0.15	0.15
Pa			25	37	37	37	
Range		in.W.G	0~0.3	0~0.3	0~0.4	0~0.4	
		Pa	0~75	0~75	0~100	0~100	
Sound Pressure Level(H/M/L)	dB(A)	45/43/41	46/44/42	49/47/45	50/48/46		
Heat Exchanger			Fenestrate plain film -- hydrophilic film				
Air Filter			PP	PP	PP	PP	
Insulation Material			Foamed polystyrene				
Refrigeration Control Device			EXV	EXV	EXV	EXV	
Protection Device			Fuse	Fuse	Fuse	Fuse	



# DC INVERTER MULTI VRF INDOOR UNIT TECHNICAL SALES GUIDE

Model			GMV-ND48A/A-T(U)	GMV-ND54A/A-T(U)	
Cooling Capacity	Btu/h		48000	54000	
	kW		14.1	15.8	
Heating Capacity	Btu/h		54000	60000	
	kW		15.8	17.6	
Casing Finish			Galvanized Steel plate		
Dimensions (W×D×H)	Outline	mm	630×540×1224	630×540×1224	
		in.	24-7/8×21-1/4×48-1/4	24-7/8×21-1/4×48-1/4	
	Packaging	mm	687×621×1295	687×621×1295	
		in.	27×24-1/2×51	27×24-1/2×51	
	Net Weight	lbs.		179	179
		kg		81	81
Gross Weight	lbs.		192	192	
	kg		87	87	
Pipe Connections	Liquid Side	mm	Φ9.52	Φ9.52	
		in.	Φ3/8	Φ3/8	
	Gas Side	mm	Φ15.9	Φ15.9	
		in.	Φ5/8	Φ5/8	
	Drain Pipe	/	G1	G1	
Power Supply			1-phase 208/230V 60Hz		
Fan	Type × Quantity		Centrifugal×1	Centrifugal×1	
	Driving Mechanism		Direct-driven	Direct-driven	
	Motor Type		BLDC	BLDC	
	Motor Power Input	W	428.7	441	
	Motor Running Current	A	3.4	3.5	
	Airflow Rate (H/M/L)	CFM		1618/1500/1353	1676/1559/1353
		m <sup>3</sup> /h		2750/2550/2300	2850/2650/2300
	External Static Pressure	Default	in.W.G	0.2	0.2
			Pa	50	50
		Range	in.W.G	0~0.5	0~0.5
Pa			0~125	0~125	
Sound Pressure Level(H/M/L)		dB(A)	51/49/47	52/50/48	
Heat Exchanger			Fenestrate plain film -- hydrophilic film		
Air Filter			PP	PP	
Insulation Material			Foamed polystyrene		
Refrigeration Control Device			EXV	EXV	
Protection Device			Fuse	Fuse	

## 2.13 AHU-KIT Type Indoor Unit

Model			GMV-N12U/A-T(U)		GMV-N24U/A-T(U)			GMV-N48U/A-T(U)			
Defaulted Capacity of ex-factory	Capacity		12		24			48			
	Cooling	kW	3.52		7.03			14.07			
	Cooling	kBtu/h	12.0		24.0			48.0			
	Heating	kW	3.96		7.91			15.83			
	Heating	kBtu/h	13.5		27.0			54.0			
Adjustable Capacity	Capacity		9	12	15	18	24	30	36	48	
	Cooling	kW	2.64	3.52	4.40	5.28	7.03	8.79	10.55	14.07	
	Cooling	kBtu/h	9.5	12.0	15.0	18.0	24.0	30.0	36.0	48.0	
	Heating	kW	3.08	3.96	4.98	5.86	7.91	9.96	11.72	15.83	
	Heating	kBtu/h	10.5	13.5	17.0	20.0	27.0	34.0	40.0	54.0	
Power Input		W	5.0		5.0			5.0			
Power Supply		Ph/V/Hz	1-Ph 208/230V 60Hz		1-Ph 208/230V 60Hz			1-Ph 208/230V 60Hz			
Size of Connection Pipe	AHU-KIT (ex-factory pipe size)		mm	Φ6.35	Φ6.35	Φ9.52	Φ9.52	Φ9.52	Φ9.52	Φ9.52	Φ9.52
			in.	Φ1/4	Φ1/4	Φ3/8	Φ3/8	Φ3/8	Φ3/8	Φ3/8	Φ3/8
	Air Handling Unit	Liquid Pipe	mm	Φ6.35	Φ6.35	Φ6.35	Φ9.52	Φ9.52	Φ9.52	Φ9.52	Φ9.52
			in.	Φ1/4	Φ1/4	Φ1/4	Φ3/8	Φ3/8	Φ3/8	Φ3/8	Φ3/8
		Gas Pipe	mm	Φ9.52	Φ12.7	Φ12.7	Φ15.9	Φ15.9	Φ15.9	Φ15.9	Φ15.9
			in.	Φ3/8	Φ1/2	Φ1/2	Φ5/8	Φ5/8	Φ5/8	Φ5/8	Φ5/8
	Connection Method			Brazing Connection		Brazing Connection			Brazing Connection		
	Outline Dimension (W×D×H)	EXV Box	mm	203×326×85		203×326×85			203×326×85		
in.			8×12-7/8×3-3/8		8×12-7/8×3-3/8			8×12-7/8×3-3/8			
Control Box		mm	334×284×111		334×284×111			334×284×111			
		in.	13-1/8×11-1/8×4-3/8		13-1/8×11-1/8×4-3/8			13-1/8×11-1/8×4-3/8			
Net Weight	kg		9.5		9.5			9.5			
	lbs		21		21			21			

# DC INVERTER MULTI VRF INDOOR UNIT TECHNICAL SALES GUIDE

Model			GMV-N96U/A-T(U)				GMV-N192U/A-T(U)			
Defaulted Capacity of ex-factory	Capacity		96				192			
	Cooling	kW	28.14				56.27			
	Cooling	kBtu/h	96.0				192			
	Heating	kW	31.65				63.31			
	Heating	kBtu/h	108.0				216			
Adjustable Capacity	Capacity		72	96	120	144	168	192	288	
	Cooling	kW	21.10	28.14	35.17	42.20	49.24	56.27	84.41	
	Cooling	kBtu/h	72	96	120	144	168	192	288	
	Heating	kW	23.74	31.65	39.57	47.48	55.39	63.31	94.96	
	Heating	kBtu/h	81	108	135	162	189	216	324	
Power Input		W	5.0				5.0			
Power Supply		Ph/V/Hz	1-Ph 208/230V 60Hz				1-Ph 208/230V 60Hz			
Size of Connection Pipe	AHU-KIT (ex-factory pipe size)		mm	Φ9.52	Φ9.52	Φ9.52	Φ9.52	Φ15.9	Φ15.9	Φ15.9
			in.	Φ3/8	Φ3/8	Φ3/8	Φ3/8	Φ5/8	Φ5/8	Φ5/8
	Air Handling Unit	Liquid Pipe	mm	Φ9.52	Φ9.52	Φ12.7	Φ12.7	Φ15.9	Φ15.9	Φ19.05
			in.	Φ3/8	Φ3/8	Φ1/2	Φ1/2	Φ5/8	Φ5/8	Φ3/4
	Gas Pipe	mm	Φ19.05	Φ22.2	Φ28.6	Φ28.6	Φ28.6	Φ28.6	Φ34.9	
		in.	Φ3/4	Φ7/8	Φ1-1/8	Φ1-1/8	Φ1-1/8	Φ1-1/8	Φ1-3/8	
Connection Method			Brazing Connection				Brazing Connection			
Outline Dimension (W×D×H)	EXV Box	mm	203×326×85				246×500×120			
		in.	8×12-7/8×3-3/8				9-5/8×19-5/8×4-3/4			
	Control Box	mm	334×284×111				334×284×111			
		in.	13-1/8×11-1/8×4-3/8				13-1/8×11-1/8×4-3/8			
Net Weight	kg		9.5				13			
	lbs		21				28			

Model			GMV-N48U/A-T(U) + GMV-N192U/A-T(U)						
Capacity			48+288						
Cooling	kW		98.48						
Cooling	kBtu/h		336						
Heating	kW		110.79						
Heating	kBtu/h		378						
Power Input		W	5.0+5.0						
Power Supply		Ph/V/Hz	1-Ph 208/230V 60Hz						
Size of Connection Pipe	Air Handling Unit	Liquid Pipe	mm	Φ19.05					
			in.	Φ3/4					
		Gas Pipe	mm	Φ34.9					
			in.	Φ1-3/8					
Outline Dimension (W×D×H)	Electronic Expansion Valve Box		mm	(203×326×85) + (246×500×120)					
			in.	(8×12-7/8×3-3/8) + (9-5/8×19-5/8×4-3/4)					
	Control Box		mm	(334×284×111)×2					
			in.	(13-1/8×11-1/8×4-3/8)×2					
Net Weight			kg	9.5+13					
			lbs	21+28					

## 2.14 1-way Cassette Type

Model		GMV-ND07TD/A-T(U)	GMV-ND09TD/A-T(U)	GMV-ND12TD/A-T(U)	
Cooling Capacity	Btu/h	7500	9500	12000	
	kW	2.2	2.8	3.6	
Heating Capacity	Btu/h	8500	10500	13500	
	kW	2.5	3.2	4	
Casing Finish		Galvanized Steel plate			
Dimensions (W×D×H)	Body Outline	mm	987×385×178	987×385×178	987×385×178
		in.	38-7/8×15-3/16×7	38-7/8×15-3/16×7	38-7/8×15-3/16×7
	Body Packaging	mm	1307×501×310	1307×501×310	1307×501×310
		in.	51-1/2×19-3/4×12-3/16	51-1/2×19-3/4×12-3/16	51-1/2×19-3/4×12-3/16
	Panel Outline	mm	1200×460×55	1200×460×55	1200×460×55
		in.	47-1/4×18-1/8×2-3/16	47-1/4×18-1/8×2-3/16	47-1/4×18-1/8×2-3/16
	Panel Packaging	mm	1265×536×118	1265×536×118	1265×536×118
		in.	49-13/16×21-1/8×4-3/4	49-13/16×21-1/8×4-3/4	49-13/16×21-1/8×4-3/4
Net Weigh	Main Body	lbs.	44	44	44
		kg	20	20	20
	Panel	lbs.	9.3	9.3	9.3
		kg	4.2	4.2	4.2
Gross Weigh	Main Body	lbs.	60	60	60
		kg	27	27	27
	Panel	lbs.	13.2	13.2	13.2
		kg	6	6	6
Pipe Connections	Liquid Side	mm	Φ6.35	Φ6.35	Φ6.35
		in.	Φ1/4	Φ1/4	Φ1/4
	Gas Side	mm	Φ9.52	Φ9.52	Φ12.7
		in.	Φ3/8	Φ3/8	Φ1/2
	Drain Pipe	mm	Φ25	Φ25	Φ25
		in.	Φ1	Φ1	Φ1
Power Supply		1-phase 208/230V 60Hz			
Fan	Type × Quantity		Cross-flow	Cross-flow	Cross-flow
	Driving Mechanism		Direct-driven	Direct-driven	Direct-driven
	Motor Type		BLDC	BLDC	BLDC
	Motor Power Input	W	30	30	30
	Motor Running Current	A	0.2	0.2	0.2
	Airflow Rate (H/M/L)	CFM	353/294/265	353/294/265	353/294/265
m <sup>3</sup> /h		600/500/450	600/500/450	600/500/450	
Sound Pressure Level(H/M/L)	dB(A)	36/32/28	36/32/28	36/32/28	
Heat Exchanger		Fenestrate plain film --hydrophilic film			
Air Filter		PP	PP	PP	
Insulation Material		Foamed polystyrene	Foamed polystyrene	Foamed polystyrene	
Refrigeration Control Device		EXV	EXV	EXV	
Protection Device		Fuse	Fuse	Fuse	
Panel Name		TD01	TD01	TD01	

# DC INVERTER MULTI VRF INDOOR UNIT TECHNICAL SALES GUIDE

## 2.15 Low Static Pressure Duct Type Indoor Unit

Model		GMV-ND30PLS/C-T(U)	GMV-ND36PLS/C-T(U)	GMV-ND42PLS/C-T(U)	GMV-ND48PLS/C-T(U)		
Product Code		CM810N2020	CM810N2010	CM810N2000	CM810N1990		
Cooling Capacity	Btu/h	30000	36000	42000	48000		
	kW	8.8	10.6	12.3	14.1		
Heating Capacity	Btu/h	34000	40000	47000	54000		
	kW	10.0	11.7	13.8	15.8		
Casing Finish		Galvanized Steel plate					
Dimensions (W×D×H)	Outline	mm	1340×655×260	1340×655×260	1340×655×260	1340×655×260	
		in.	52-3/4×25-13/16×10-1/4	52-3/4×25-13/16×10-1/4	52-3/4×25-13/16×10-1/4	52-3/4×25-13/16×10-1/4	
	Packaging	mm	1588×858×315	1588×858×315	1588×858×315	1588×858×315	
		in.	62-1/2×33-3/4×12-3/8	62-1/2×33-3/4×12-3/8	62-1/2×33-3/4×12-3/8	62-1/2×33-3/4×12-3/8	
Net Weight	lbs.	100	100	102	102		
	kg	45.5	45.5	46.5	46.5		
Gross Weight	lbs.	120	120	122	122		
	kg	54.5	54.5	55.5	55.5		
Pipe Connection	Liquid Side	mm	Φ9.52	Φ9.52	Φ9.52	Φ9.52	
		in.	Φ3/8	Φ3/8	Φ3/8	Φ3/8	
	Gas Side	mm	Φ15.9	Φ15.9	Φ15.9	Φ15.9	
		in.	Φ5/8	Φ5/8	Φ5/8	Φ5/8	
	Drain Pipe	mm	Φ25	Φ25	Φ25	Φ25	
		in.	Φ2.5	Φ2.5	Φ2.5	Φ2.5	
Power Supply		1-phase 208/230V 60Hz					
Fan	Type × Quantity		Centrifugal×3	Centrifugal×3	Centrifugal×3	Centrifugal×3	
	Driving Mechanism		Direct-driven				
	Motor Type		BLDC				
	Motor Power Input	W	130	130	170	170	
	Motor Running Current	A	2.4	2.4	2.4	2.4	
	Airflow Rate (H/M/L)	CFM	880/735/530	1000/880/650	1180/1000/825	1180/1000/825	
		m <sup>3</sup> /h	1500/1250/900	1700/1500/1100	2000/1700/1400	2000/1700/1400	
	External Static Pressure	Default	in.W.G.	0.2	0.2	0.2	0.2
			Pa	50	50	50	50
		Range	in.W.G.	0~0.32	0~0.32	0~0.32	0~0.32
Pa			0~80	0~80	0~80	0~80	
Sound Pressure Level(H/M/L)		dB(A)	40/36/32	40/36/32	42/40/37	42/40/37	
Heat Exchanger		Fenestrate plain film --hydrophilic film					
Air Filter		PP					
Refrigeration Control Device		EXV					
Protection Device		Fuse					

## 2.16 360°Air Discharge Compact Cassette Type

Model		GMV-ND05T/E-T(U)	GMV-ND07T/E-T(U)	GMV-ND09T/E-T(U)	
Product Code		CM500N1600	CM500N1590	CM500N1620	
Cooling Capacity	Btu/h	5800	7500	9500	
	kW	1.7	2.2	2.8	
Heating Capacity	Btu/h	6200	8500	10500	
	kW	1.8	2.5	3.1	
Casing Finish		Galvanized Steel plate			
Dimensions (W×D×H)	Body Outline	mm	570×570×265	570×570×265	570×570×265
		inch	22-7/16×22-7/16×10-7/16	22-7/16×22-7/16×10-7/16	22-7/16×22-7/16×10-7/16
	Body Packaging	mm	698×653×295	698×653×295	698×653×295
		inch	27-1/2×25-11/16×11-5/8	27-1/2×25-11/16×11-5/8	27-1/2×25-11/16×11-5/8
	Panel Outline	mm	620×620×47.5	620×620×47.5	620×620×47.5
		inch	24-3/8×24-3/8×1-7/8	24-3/8×24-3/8×1-7/8	24-3/8×24-3/8×1-7/8
Panel Packaging	mm	701×701×125	701×701×125	701×701×125	
	inch	27-5/8×27-5/8×5	27-5/8×27-5/8×5	27-5/8×27-5/8×5	
Net Weigh	Main Body	lbs.	38.6	38.6	38.6
		kg	17.5	17.5	17.5
	Panel	lbs.	6.6	6.6	6.6
		kg	3.0	3.0	3.0
Gross Weigh	Main Body	lbs.	49.6	49.6	49.6
		kg	22.5	22.5	22.5
	Panel	lbs.	10	10	10
		kg	4.5	4.5	4.5
Pipe Connections	Liquid Side	mm	Φ6.35	Φ6.35	Φ6.35
		inch	Φ1/4	Φ1/4	Φ1/4
	Gas Side	mm	Φ9.52	Φ9.52	Φ9.52
		inch	Φ3/8	Φ3/8	Φ3/8
	Drain Pipe	mm	Φ25	Φ25	Φ25
		inch	Φ1	Φ1	Φ1
Power Supply		1-phase 208/230V 60Hz			
Fan	Type × Quantity		Centrifugal×1	Centrifugal×1	Centrifugal×1
	Driving Mechanism		Direct-driven	Direct-driven	Direct-driven
	Motor Type		BLDC	BLDC	BLDC
	Motor Power Input	W	35	35	35
	Motor Running Current	A	0.3	0.3	0.3
	Airflow Rate(H/M/L)	CFM	270/250/220	295/270/220	335/280/250
	m <sup>3</sup> /h	460/420/370	500/460/370	570/480/420	
Sound Pressure Level(H/M/L)	dB(A)	33/30/25	36/31/25	36/33/28	
Heat Exchanger		Fenestrate plain film --hydrophilic film			
Air Filter		PP	PP	PP	
Insulation Material		Foamed polystyrene	Foamed polystyrene	Foamed polystyrene	
Refrigeration Control Device		EXV	EXV	EXV	
Protection Device		Fuse	Fuse	Fuse	
Panel Name		TF05	TF05	TF05	

# DC INVERTER MULTI VRF INDOOR UNIT TECHNICAL SALES GUIDE

Model			GMV-ND12T/E-T(U)	GMV-ND15T/E-T(U)	GMV-ND18T/E-T(U)
Product Code			CM500N1580	CM500N1610	CM500N1570
Cooling Capacity	Btu/h		12000	15000	18000
	kW		3.5	4.4	5.3
Heating Capacity	Btu/h		13500	17000	20000
	kW		4	5	5.9
Casing Finish			Galvanized Steel plate		
Dimensions (W×D×H)	Body Outline	mm	570×570×265	570×570×265	570×570×265
		inch	22-7/16×22-7/16×10-7/16	22-7/16×22-7/16×10-7/16	22-7/16×22-7/16×10-7/16
	Body Packaging	mm	698×653×295	698×653×295	698×653×295
		inch	27-1/2×25-11/16×11-5/8	27-1/2×25-11/16×11-5/8	27-1/2×25-11/16×11-5/8
	Panel Outline	mm	620×620×47.5	620×620×47.5	620×620×47.5
		inch	24-3/8×24-3/8×1-7/8	24-3/8×24-3/8×1-7/8	24-3/8×24-3/8×1-7/8
	Panel Packaging	mm	701×701×125	701×701×125	701×701×125
		inch	27-5/8×27-5/8×5	27-5/8×27-5/8×5	27-5/8×27-5/8×5
Net Weigh	Main Body	lbs.	38.6	38.6	38.6
		kg	17.5	17.5	17.5
	Panel	lbs.	6.6	6.6	6.6
		kg	3.0	3.0	3.0
Gross Weigh	Main Body	lbs.	49.6	49.6	49.6
		kg	22.5	22.5	22.5
	Panel	lbs.	10	10	10
		kg	4.5	4.5	4.5
Pipe Connections	Liquid Side	mm	Φ6.35	Φ6.35	Φ9.52
		inch	Φ1/4	Φ1/4	Φ3/8
	Gas Side	mm	Φ12.7	Φ12.7	Φ15.9
		inch	Φ1/2	Φ1/2	Φ5/8
	Drain Pipe	mm	Φ25	Φ25	Φ25
		inch	Φ1	Φ1	Φ1
Power Supply			1-phase 208/230V 60Hz		
Fan	Type × Quantity		Centrifugal×1	Centrifugal×1	Centrifugal×1
	Driving Mechanism		Direct-driven	Direct-driven	Direct-driven
	Motor Type		BLDC	BLDC	BLDC
	Motor Power Input	W	46	46	46
	Motor Running Current	A	0.4	0.4	0.4
	Airflow Rate (H/M/L)	CFM		365/325/280	430/385/330
m <sup>3</sup> /h			620/550/480	730/650/560	730/650/560
Sound Pressure Level(H/M/L)	dB(A)		39/37/35	43/41/39	43/41/39
Heat Exchanger			Fenestrate plain film --hydrophilic film		
Air Filter			PP	PP	PP
Insulation Material			Foamed polystyrene	Foamed polystyrene	Foamed polystyrene
Refrigeration Control Device			EXV	EXV	EXV
Protection Device			Fuse	Fuse	Fuse
Panel Name			TF05	TF05	TF05

## 2.17 360° Air Discharge Cassette Indoor Unit

Model		GMV-ND07T/ C-T(U)	GMV-ND09T/ C-T(U)	GMV-ND12T/ C-T(U)	GMV-ND15T/ C-T(U)	GMV-ND18T/ C-T(U)		
Product Code		CM500N1560	CM500N1480	CM500N1530	CM500N1460	CM500N1470		
Cooling Capacity	Btu/h	7500	9500	12000	15000	18000		
	kW	2.2	2.8	3.5	4.4	5.3		
Heating Capacity	Btu/h	8500	10500	13500	17000	20000		
	kW	2.5	3.1	4.0	5	5.9		
Casing Finish		Galvanized Steel plate						
Dimensions (W×D×H)	Body Outline	mm	840×840×240	840×840×240	840×840×240	840×840×240	840×840×240	
		inch	33-1/8×33-1/8×9-1/2	33-1/8×33-1/8×9-1/2	33-1/8×33-1/8×9-1/2	33-1/8×33-1/8×9-1/2	33-1/8×33-1/8×9-1/2	
	Body Packaging	mm	963×963×325	963×963×325	963×963×325	963×963×325	963×963×325	
		inch	37-7/8×37-7/8×12-3/4	37-7/8×37-7/8×12-3/4	37-7/8×37-7/8×12-3/4	37-7/8×37-7/8×12-3/4	37-7/8×37-7/8×12-3/4	
	Panel Outline	mm	950×950×65	950×950×65	950×950×65	950×950×65	950×950×65	
		inch	37-3/8×37-3/8×2-1/2	37-3/8×37-3/8×2-1/2	37-3/8×37-3/8×2-1/2	37-3/8×37-3/8×2-1/2	37-3/8×37-3/8×2-1/2	
	Panel Packaging	mm	1038×1033×112	1038×1033×112	1038×1033×112	1038×1033×112	1038×1033×112	
		inch	40-7/8×40-7/8×4-3/8	40-7/8×40-7/8×4-3/8	40-7/8×40-7/8×4-3/8	40-7/8×40-7/8×4-3/8	40-7/8×40-7/8×4-3/8	
	Net Weigh	Main Body	lbs.	64	64	64	64	64
			kg	29	29	29	29	29
Panel		lbs.	13	13	13	13	13	
		kg	6	6	6	6	6	
Gross Weigh	Main Body	lbs.	82	82	82	82	82	
		kg	37	37	37	37	37	
	Panel	lbs.	21	21	21	21	21	
		kg	9.5	9.5	9.5	9.5	9.5	
Pipe Connections	Liquid Side	mm	Φ6.35	Φ6.35	Φ6.35	Φ6.35	Φ9.52	
		inch	Φ1/4	Φ1/4	Φ1/4	Φ1/4	Φ3/8	
	Gas Side	mm	Φ9.52	Φ9.52	Φ12.7	Φ12.7	Φ15.9	
		inch	Φ3/8	Φ3/8	Φ1/2	Φ1/2	Φ5/8	
	Drain Pipe	mm	Φ25	Φ25	Φ25	Φ25	Φ25	
		inch	Φ1	Φ1	Φ1	Φ1	Φ1	
Power supply		1-phase 208/230V 60Hz						
Fan	Type × Quantity		Centrifugal×1	Centrifugal×1	Centrifugal×1	Centrifugal×1	Centrifugal×1	
	Driving Mechanism		Direct-driven	Direct-driven	Direct-driven	Direct-driven	Direct-driven	
	Motor Type		BLDC	BLDC	BLDC	BLDC	BLDC	
	Motor Running Current	A	0.6	0.6	0.6	0.6	0.7	
	Airflow Rate (H/M/L)	CFM	470/410/355	470/410/355	470/410/355	470/410/355	560/500/440	
m <sup>3</sup> /h		800/700/600	800/700/600	800/700/600	800/700/600	950/850/750		
Sound Pressure Level(H/M/L)	dB(A)	34/32/30	34/32/30	34/32/30	34/32/30	38/36/33		
Heat Exchanger		Fenestrate plain film --hydrophilic film						
Air Filter		PP	PP	PP	PP	PP		
Insulation Material		Foamed polystyrene	Foamed polystyrene	Foamed polystyrene	Foamed polystyrene	Foamed polystyrene		
Refrigeration Control Device		EXV	EXV	EXV	EXV	EXV		
Protection Device		Fuse	Fuse	Fuse	Fuse	Fuse		
Panel Name		TF06	TF06	TF06	TF06	TF06		



# DC INVERTER MULTI VRF INDOOR UNIT TECHNICAL SALES GUIDE

Model		GMV-ND22T/ C-T(U)	GMV-ND24T/ C-T(U)	GMV-ND30T/ C-T(U)	GMV-ND36T/ C-T(U)	GMV-ND42T/ C-T(U)	GMV-ND48T/ C-T(U)		
Product Code		CM500N1520	CM500N1490	CM500N1550	CM500N1500	CM500N1450	CM500N1540		
Cooling Capacity	Btu/h	22000	24000	30000	36000	42000	48000		
	kW	6.4	7	8.8	10.6	12.3	14.1		
Heating Capacity	Btu/h	24000	27000	34000	40000	47000	54000		
	kW	7	7.9	10	11.7	13.8	15.8		
Casing Finish		Galvanized Steel plate							
Dimensions (W×D×H)	Body Outline	mm	840×840×240	840×840×240	840×840×290	840×840×290	840×840×290	840×840×290	
		inch	33-1/8×33-1/8×9-1/2	33-1/8×33-1/8×9-1/2	33-1/8×33-1/8×11-3/8	33-1/8×33-1/8×11-3/8	33-1/8×33-1/8×11-3/8	33-1/8×33-1/8×11-3/8	
	Body Packaging	mm	963×963×325	963×963×325	963×963×379	963×963×379	963×963×379	963×963×379	
		inch	37-7/8×37-7/8×12-3/4	37-7/8×37-7/8×12-3/4	37-7/8×37-7/8×14-7/8	37-7/8×37-7/8×14-7/8	37-7/8×37-7/8×14-7/8	37-7/8×37-7/8×14-7/8	
	Panel Outline	mm	950×950×65	950×950×65	950×950×65	950×950×65	950×950×65	950×950×65	
		inch	37-3/8×37-3/8×2-1/2	37-3/8×37-3/8×2-1/2	37-3/8×37-3/8×2-1/2	37-3/8×37-3/8×2-1/2	37-3/8×37-3/8×2-1/2	37-3/8×37-3/8×2-1/2	
	Panel Packaging	mm	1038×1033×112	1038×1033×112	1038×1033×112	1038×1033×112	1038×1033×112	1038×1033×112	
		inch	40-7/8×40-5/8×4-3/8	40-7/8×40-5/8×4-3/8	40-7/8×40-5/8×4-3/8	40-7/8×40-5/8×4-3/8	40-7/8×40-5/8×4-3/8	40-7/8×40-5/8×4-3/8	
	Net Weight	Main Body	lbs.	64	64	73	73	73	73
			kg	29	29	33	33	33	33
Panel		lbs.	13	13	13	13	13	13	
		kg	6	6	6	6	6	6	
Gross Weight	Main Body	lbs.	82	82	93	93	93	93	
		kg	37	37	42	42	42	42	
	Panel	lbs.	21	21	21	21	21	21	
		kg	9.5	9.5	9.5	9.5	9.5	9.5	
Pipe Connections	Liquid Side	mm	Φ9.52	Φ9.52	Φ9.52	Φ9.52	Φ9.52	Φ9.52	
		inch	Φ3/8	Φ3/8	Φ3/8	Φ3/8	Φ3/8	Φ3/8	
	Gas Side	mm	Φ15.9	Φ15.9	Φ15.9	Φ15.9	Φ15.9	Φ15.9	
		inch	Φ5/8	Φ5/8	Φ5/8	Φ5/8	Φ5/8	Φ5/8	
	Drain Pipe	mm	Φ25	Φ25	Φ25	Φ25	Φ25	Φ25	
		inch	Φ1	Φ1	Φ1	Φ1	Φ1	Φ1	
Power Supply		1-phase 208/230V 60Hz							
Fan	Type × Quantity		Centrifugal×1	Centrifugal×1	Centrifugal×1	Centrifugal×1	Centrifugal×1	Centrifugal×1	
	Driving Mechanism		Direct-driven	Direct-driven	Direct-driven	Direct-driven	Direct-driven	Direct-driven	
	Motor Type		BLDC	BLDC	BLDC	BLDC	BLDC	BLDC	
	Motor Running Current	A	0.7	0.7	0.8	1.0	1.5	1.5	
		Airflow Rate(H/M/L)	CFM	560/500/440	675/560/500	1250/1000/900	1500/1200/1000	1650/1300/1100	1650/1300/1100
m <sup>3</sup> /h	950/850/750		1150/950/850	735/590/530	885/705/590	970/765/645	970/765/645		
Sound Pressure Level(H/M/L)	dB(A)	38/36/33	38/36/34	38/34/31	43/39/37	45/41/39	45/41/39		
Heat Exchanger		Fenestrate plain film --hydrophilic film							
Air Filter		PP	PP	PP	PP	PP	PP		
Insulation Material		Foamed polystyrene	Foamed polystyrene	Foamed polystyrene	Foamed polystyrene	Foamed polystyrene	Foamed polystyrene		
Refrigeration Control Device		EXV	EXV	EXV	EXV	EXV	EXV		
Protection Device		Fuse	Fuse	Fuse	Fuse	Fuse	Fuse		
Panel Name		TF06	TF06	TF06	TF06	TF06	TF06		

### 3 ELECTRICAL SPECIFICATIONS

#### 3.1 Low Static Pressure Duct Type Indoor Unit

Model		GMV-ND07PLS/ A-T(U)	GMV-ND09PLS/ A-T(U)	GMV-ND12PLS/ A-T(U)	GMV-ND14PLS/ A-T(U)	GMV-ND18PLS/ A-T(U)	GMV-ND22PLS/ A-T(U)
MCA	A	1	1	1	1	1	1
MOP	A	15	15	15	15	15	15
Fuse	A	15	15	15	15	15	15

#### 3.2 Slim Duct Type Indoor Unit

Model		GMV-ND07PLS/ B-T(U)	GMV-ND09PLS/ B-T(U)	GMV-ND12PLS/ B-T(U)	GMV-ND14PLS/ B-T(U)	GMV-ND18PLS/ B-T(U)	GMV-ND22PLS/ B-T(U)
MCA	A	1	1	1	1	1	1
MOP	A	15	15	15	15	15	15
Fuse	A	15	15	15	15	15	15

#### 3.3 Four-way Cassette Indoor

Model		GMV-ND07T/ A-T(U)	GMV-ND09T/ A-T(U)	GMV-ND12T/ A-T(U)	GMV-ND15T/ A-T(U)	GMV-ND18T/ A-T(U)
MCA	A	1	1	1	1	1
MOP	A	15	15	15	15	15
Fuse	A	15	15	15	15	15

Model		GMV-ND24T/ A-T(U)	GMV-ND30T/ A-T(U)	GMV-ND36T/ A-T(U)	GMV-ND42T/ A-T(U)	GMV-ND48T/ A-T(U)
MCA	A	1	1	1	1	1
MOP	A	15	15	15	15	15
Fuse	A	15	15	15	15	15

#### 3.4 High Static Pressure Duct Type Indoor Unit

Model		GMV-ND18PHS/ A-T(U)	GMV-ND24PHS/ A-T(U)	GMV-ND30PHS/ A-T(U)	GMV-ND36PHS/ A-T(U)	GMV-ND42PHS/ A-T(U)	GMV-ND48PHS/ A-T(U)
MCA	A	1.2	1.2	1.8	1.8	2	2
MOP	A	15	15	15	15	15	15
Fuse	A	15	15	15	15	15	15

Model		GMV-ND72PH/A-T(U)		GMV-ND96PH/A-T(U)	
MCA	A	6.3		7.5	
MOP	A	15		15	
Fuse	A	15		15	

#### 3.5 Floor Ceiling Type Indoor Unit

Model		GMV-ND09ZD/A-T(U)	GMV-ND12ZD/A-T(U)	GMV-ND18ZD/A-T(U)	GMV-ND24ZD/A-T(U)
MCA	A	1	1	1	1
MOP	A	15	15	15	15
Fuse	A	15	15	15	15

Model		GMV-ND30ZD/A-T(U)	GMV-ND36ZD/A-T(U)	GMV-ND42ZD/A-T(U)	GMV-ND48ZD/A-T(U)
MCA	A	1	1	1	1
MOP	A	15	15	15	15
Fuse	A	15	15	15	15

## 3.6 Wall Mounted Type Indoor Unit

Model		GMV-N07G/A3A-D(U)	GMV-N09G/A3A-D(U)	GMV-N12G/A3A-D(U)	GMV-N18G/A3A-D(U)	GMV-N24G/A3A-D(U)
MCA	A	1	1	1	1	1
MOP	A	15	15	15	15	15

Model		GMV-ND06G/B4B-T(U)	GMV-ND07G/B4B-T(U)	GMV-ND09G/B4B-T(U)	GMV-ND12G/B4B-T(U)	GMV-ND14G/B4B-T(U)
MCA	A	1	1	1	1	1
MOP	A	15	15	15	15	15

Model		GMV-ND18G/B4B-T(U)	GMV-ND24G/B4B-T(U)	GMV-ND30G/B4B-T(U)	GMV-ND36G/B4B-T(U)
MCA	A	1	1	1	1
MOP	A	15	15	15	15

## 3.7 Fresh Air Processing Unit

Model		GMV-NDX72P/A-T(U)	GMV-NDX96P/A-T(U)
MCA	A	6.3	6.3
MOP	A	15	15
Fuse	A	15	15

## 3.8 Console Type

Model		GMV-ND07C/A-T(U)	GMV-ND09C/A-T(U)	GMV-ND12C/A-T(U)	GMV-ND18C/A-T(U)
MCA	A	1	1	1	1
MOP	A	15	15	15	15
Fuse	A	15	15	15	15

## 3.9 Two-way Cassette Type

Model		GMV-ND09TS/A-T(U)	GMV-ND12TS/A-T(U)	GMV-ND15TS/A-T(U)	GMV-ND18TS/A-T(U)	GMV-ND24TS/A-T(U)
MCA	A	1	1	1	1	1
MOP	A	15	15	15	15	15
Fuse	A	15	15	15	15	15

## 3.10 Compact Four-way Cassette Type

Model		GMV-ND07T/B-T(U)	GMV-ND09T/B-T(U)	GMV-ND12T/B-T(U)	GMV-ND15T/B-T(U)	GMV-ND18T/B-T(U)
MCA	A	2	2	2	2	2
MOP	A	15	15	15	15	15
Fuse	A	15	15	15	15	15

## 3.11 Super High Static Pressure Duct Type Indoor Unit

Model		GMV-ND07PHS/B-T(U)	GMV-ND09PHS/B-T(U)	GMV-ND12PHS/B-T(U)	GMV-ND15PHS/B-T(U)	GMV-ND18PHS/B-T(U)	GMV-ND22PHS/B-T(U)
MCA	A	1	1	1	1	1	1
MOP	A	15	15	15	15	15	15
Fuse	A	15	15	15	15	15	15

Model		GMV-ND24PHS/B-T(U)	GMV-ND30PHS/B-T(U)	GMV-ND36PHS/B-T(U)	GMV-ND42PHS/B-T(U)	GMV-ND48PHS/B-T(U)	GMV-ND54PHS/B-T(U)
MCA	A	1.2	1.7	1.7	1.7	1.7	1.7
MOP	A	15	15	15	15	15	15
Fuse	A	15	15	15	15	15	15

Model		GMV-ND72PH/B-T(U)	GMV-ND96PH/B-T(U)
MCA	A	5.7	6.8
MOP	A	15	15
Fuse	A	15	15

### 3.12 Air Handler Type Indoor Unit

Model		GMV-ND09A/A-T(U)	GMV-ND12A/A-T(U)	GMV-ND18A/A-T(U)	GMV-ND24A/A-T(U)	GMV-ND30A/A-T(U)
MCA	A	1.4	1.4	1.4	1.4	1.8
MOP	A	15	15	15	15	15
Fuse	A	15	15	15	15	15

Model		GMV-ND36A/A-T(U)	GMV-ND42A/A-T(U)	GMV-ND48A/A-T(U)	GMV-ND54A/A-T(U)
MCA	A	3.3	3.4	4.3	4.4
MOP	A	15	15	15	15
Fuse	A	15	15	15	15

### 3.13 AHU-KIT Type Indoor Unit

Model		GMV-N12U/A-T(U)	GMV-N24U/A-T(U)	GMV-N48U/A-T(U)	GMV-N96U/A-T(U)	GMV-N192U/A-T(U)
MCA	A	10	10	10	10	10
MOP	A	15	15	15	15	15
Fuse	A	15	15	15	15	15

### 3.14 1-way Cassette Type

Model		GMV-ND07TD/A-T(U)	GMV-ND09TD/A-T(U)	GMV-ND12TD/A-T(U)
MCA	A	0.375	0.375	0.375
MOP	A	15	15	15
Fuse	A	15	15	15

### 3.15 Low Static Pressure Duct Type Indoor Unit

Model		GMV-ND30PLS/C-T(U)	GMV-ND36PLS/C-T(U)	GMV-ND42PLS/C-T(U)	GMV-ND48PLS/C-T(U)
MCA	A	3.0	3.0	3.0	3.0
MOP	A	15	15	15	15
Fuse	A	15	15	15	15

### 3.16 360°Air Discharge Compact Cassette Type

Model		GMV-ND05T/ET(U)	GMV-ND07T/E-T(U)	GMV-ND09T/E-T(U)	GMV-ND12T/E-T(U)	GMV-ND15T/E-T(U)	GMV-ND18T/E-T(U)
MCA	A	0.7	0.7	0.7	0.8	0.8	0.8
MOP	A	15	15	15	15	15	15
Fuse	A	15	15	15	15	15	15

### 3.17 360°Air Discharge Cassette Type

Model		GMV-ND07T/C-T(U)	GMV-ND09T/C-T(U)	GMV-ND12T/C-T(U)	GMV-ND15T/C-T(U)	GMV-ND18T/C-T(U)	GMV-ND22T/C-T(U)
MCA	A	0.8	0.8	0.8	0.8	1.0	1.0
MOP	A	15	15	15	15	15	15
Fuse	A	15	15	15	15	15	15

Model		GMV-ND24T/C-T(U)	GMV-ND30T/C-T(U)	GMV-ND36T/C-T(U)	GMV-ND42T/C-T(U)	GMV-ND48T/C-T(U)
MCA	A	1.0	2.0	2.0	2.0	2.0
MOP	A	15	15	15	15	15
Fuse	A	15	15	15	15	15

## 4 COOLING/HEATING CAPACITY CORRECTION

### 4.1 Cooling Capacity Correction

TC: Total Capacity; SC: Sensible Capacity

Cooling Capacity (kBtu/h)	Outdoor temperature (°FDB)	Indoor temperature (°FWB/°FDB)													
		57.2°FWB		60.8°FWB		64.4°FWB		66.2°FWB		68.0°FWB		71.6°FWB		75.2°FWB	
		68.0°FDB		73.4°FDB		78.8°FDB		80.6°FDB		82.4°FDB		86.0°FDB		89.6°FDB	
		TC	SC	TC	SC	TC	SC	TC	SC	TC	SC	TC	SC	TC	SC
05	10.0	1.16	0.88	1.24	0.97	1.56	1.25	1.70	1.28	1.84	1.30	2.09	1.36	2.28	1.48
	12.0	1.16	0.88	1.24	0.97	1.56	1.25	1.70	1.28	1.84	1.30	2.09	1.36	2.28	1.48
	14.0	1.16	0.88	1.24	0.97	1.56	1.25	1.70	1.28	1.84	1.30	2.09	1.36	2.28	1.48
	16.0	1.16	0.88	1.24	0.97	1.56	1.25	1.70	1.28	1.84	1.30	2.09	1.36	2.28	1.48
	18.0	1.16	0.88	1.24	0.97	1.56	1.25	1.70	1.28	1.84	1.30	2.09	1.36	2.28	1.48
	20.0	1.16	0.88	1.24	0.97	1.56	1.25	1.70	1.28	1.84	1.30	2.09	1.36	2.28	1.48
	21.0	1.16	0.88	1.24	0.97	1.56	1.25	1.70	1.28	1.84	1.30	2.09	1.36	2.28	1.48
	23.0	1.16	0.88	1.24	0.97	1.56	1.25	1.70	1.28	1.84	1.30	2.09	1.36	2.28	1.48
	25.0	1.16	0.88	1.24	0.97	1.56	1.25	1.70	1.28	1.84	1.30	2.09	1.36	2.28	1.48
	27.0	1.16	0.88	1.24	0.97	1.56	1.25	1.70	1.28	1.84	1.30	2.09	1.36	2.28	1.48
	29.0	1.16	0.88	1.24	0.97	1.56	1.25	1.70	1.28	1.84	1.30	2.09	1.36	2.28	1.48
	31.0	1.16	0.88	1.24	0.97	1.56	1.25	1.70	1.28	1.84	1.30	2.09	1.36	2.28	1.48
	33.0	1.16	0.88	1.24	0.97	1.56	1.25	1.70	1.28	1.84	1.30	2.09	1.36	2.28	1.48
	35.0	1.16	0.88	1.24	0.97	1.56	1.25	1.70	1.28	1.84	1.30	2.09	1.36	2.28	1.48
	37.0	1.16	0.88	1.24	0.97	1.56	1.25	1.70	1.28	1.84	1.30	2.09	1.36	2.28	1.48
39.0	1.16	0.88	1.24	0.97	1.56	1.25	1.70	1.28	1.84	1.30	2.09	1.36	2.28	1.48	
40.0	1.16	0.88	1.24	0.97	1.56	1.25	1.70	1.28	1.84	1.30	2.09	1.36	2.28	1.48	
43.0	1.16	0.88	1.24	0.97	1.56	1.25	1.70	1.28	1.84	1.30	2.09	1.36	2.28	1.48	
07	50.0	1.5	1.1	1.6	1.3	2.0	1.6	2.2	1.7	2.4	1.7	2.7	1.8	2.9	1.9
	53.6	1.5	1.1	1.6	1.3	2.0	1.6	2.2	1.7	2.4	1.7	2.7	1.8	2.9	1.9
	57.2	1.5	1.1	1.6	1.3	2.0	1.6	2.2	1.7	2.4	1.7	2.7	1.8	2.9	1.9
	60.8	1.5	1.1	1.6	1.3	2.0	1.6	2.2	1.7	2.4	1.7	2.7	1.8	2.9	1.9
	64.4	1.5	1.1	1.6	1.3	2.0	1.6	2.2	1.7	2.4	1.7	2.7	1.8	2.9	1.9
	68.0	1.5	1.1	1.6	1.3	2.0	1.6	2.2	1.7	2.4	1.7	2.7	1.8	2.9	1.9
	69.8	1.5	1.1	1.6	1.3	2.0	1.6	2.2	1.7	2.4	1.7	2.7	1.8	2.9	1.9
	73.4	1.5	1.1	1.6	1.3	2.0	1.6	2.2	1.7	2.4	1.7	2.7	1.8	2.8	1.9
	77.0	1.5	1.1	1.6	1.3	2.0	1.6	2.2	1.7	2.4	1.7	2.7	1.8	2.8	1.9
	80.6	1.5	1.1	1.6	1.3	2.0	1.6	2.2	1.7	2.4	1.7	2.6	1.8	2.8	1.8
	84.2	1.5	1.1	1.6	1.3	2.0	1.6	2.2	1.7	2.4	1.7	2.6	1.8	2.7	1.8
	87.8	1.5	1.1	1.6	1.3	2.0	1.6	2.2	1.7	2.4	1.7	2.6	1.8	2.7	1.8
	91.4	1.5	1.1	1.6	1.3	2.0	1.6	2.2	1.7	2.4	1.7	2.5	1.8	2.6	1.8
	95.0	1.5	1.1	1.6	1.3	2.0	1.6	2.2	1.7	2.4	1.7	2.5	1.8	2.6	1.8
	98.6	1.5	1.1	1.6	1.3	2.0	1.6	2.2	1.7	2.4	1.7	2.5	1.8	2.6	1.8
102.2	1.5	1.1	1.6	1.3	2.0	1.6	2.2	1.7	2.4	1.7	2.4	1.8	2.5	1.7	
104.0	1.5	1.1	1.6	1.3	2.0	1.6	2.2	1.7	2.3	1.7	2.4	1.8	2.5	1.7	
109.4	1.5	1.1	1.6	1.3	2.0	1.6	2.2	1.7	2.3	1.7	2.4	1.7	2.4	1.7	

Cooling Capacity (kBtu/h)	Outdoor temperature (°FDB)	Indoor temperature (°FWB/°FDB)													
		57.2°FWB		60.8°FWB		64.4°FWB		66.2°FWB		68.0°FWB		71.6°FWB		75.2°FWB	
		68.0°FDB		73.4°FDB		78.8°FDB		80.6°FDB		82.4°FDB		86.0°FDB		89.6°FDB	
		TC	SC	TC	SC	TC	SC	TC	SC	TC	SC	TC	SC	TC	SC
09	50.0	1.9	1.4	2.0	1.6	2.6	2.1	2.8	2.1	3.0	2.1	3.4	2.2	3.8	2.4
	53.6	1.9	1.4	2.0	1.6	2.6	2.1	2.8	2.1	3.0	2.1	3.4	2.2	3.8	2.4
	57.2	1.9	1.4	2.0	1.6	2.6	2.1	2.8	2.1	3.0	2.1	3.4	2.2	3.8	2.4
	60.8	1.9	1.4	2.0	1.6	2.6	2.1	2.8	2.1	3.0	2.1	3.4	2.2	3.8	2.4
	64.4	1.9	1.4	2.0	1.6	2.6	2.1	2.8	2.1	3.0	2.1	3.4	2.2	3.8	2.4
	68.0	1.9	1.4	2.0	1.6	2.6	2.1	2.8	2.1	3.0	2.1	3.4	2.2	3.7	2.5
	69.8	1.9	1.4	2.0	1.6	2.6	2.1	2.8	2.1	3.0	2.1	3.4	2.2	3.6	2.4
	73.4	1.9	1.4	2.0	1.6	2.6	2.1	2.8	2.1	3.0	2.1	3.4	2.2	3.6	2.4
	77.0	1.9	1.4	2.0	1.6	2.6	2.1	2.8	2.1	3.0	2.1	3.4	2.3	3.5	2.4
	80.6	1.9	1.4	2.0	1.6	2.6	2.1	2.8	2.1	3.0	2.1	3.3	2.3	3.5	2.3
	84.2	1.9	1.4	2.0	1.6	2.6	2.1	2.8	2.1	3.0	2.1	3.3	2.3	3.4	2.3
	87.8	1.9	1.4	2.0	1.6	2.6	2.1	2.8	2.1	3.0	2.1	3.2	2.3	3.4	2.3
	91.4	1.9	1.4	2.0	1.6	2.6	2.1	2.8	2.1	3.0	2.1	3.2	2.3	3.3	2.3
	95.0	1.9	1.4	2.0	1.6	2.6	2.1	2.8	2.1	3.0	2.1	3.2	2.3	3.3	2.3
	98.6	1.9	1.4	2.0	1.6	2.6	2.1	2.8	2.1	3.0	2.2	3.1	2.3	3.2	2.2
	102.2	1.9	1.4	2.0	1.6	2.6	2.1	2.8	2.1	3.0	2.2	3.1	2.2	3.2	2.1
104.0	1.9	1.4	2.0	1.6	2.6	2.1	2.8	2.1	2.9	2.2	3.1	2.2	3.1	2.2	
109.4	1.9	1.4	2.0	1.6	2.6	2.1	2.8	2.1	2.9	2.1	3.0	2.2	3.1	2.2	
12	50.0	2.4	1.8	2.6	2.0	3.2	2.6	3.5	2.6	3.8	2.7	4.3	2.8	4.7	3.0
	53.6	2.4	1.8	2.6	2.0	3.2	2.6	3.5	2.6	3.8	2.7	4.3	2.8	4.7	3.0
	57.2	2.4	1.8	2.6	2.0	3.2	2.6	3.5	2.6	3.8	2.7	4.3	2.8	4.7	3.0
	60.8	2.4	1.8	2.6	2.0	3.2	2.6	3.5	2.6	3.8	2.7	4.3	2.8	4.7	3.0
	64.4	2.4	1.8	2.6	2.0	3.2	2.6	3.5	2.6	3.8	2.7	4.3	2.8	4.7	3.0
	68.0	2.4	1.8	2.6	2.0	3.2	2.6	3.5	2.6	3.8	2.7	4.3	2.8	4.7	3.1
	69.8	2.4	1.8	2.6	2.0	3.2	2.6	3.5	2.6	3.8	2.7	4.3	2.8	4.6	3.0
	73.4	2.4	1.8	2.6	2.0	3.2	2.6	3.5	2.6	3.8	2.7	4.3	2.8	4.5	3.0
	77.0	2.4	1.8	2.6	2.0	3.2	2.6	3.5	2.6	3.8	2.7	4.2	2.8	4.4	3.0
	80.6	2.4	1.8	2.6	2.0	3.2	2.6	3.5	2.6	3.8	2.7	4.2	2.8	4.4	2.9
	84.2	2.4	1.8	2.6	2.0	3.2	2.6	3.5	2.6	3.8	2.7	4.1	2.8	4.3	2.9
	87.8	2.4	1.8	2.6	2.0	3.2	2.6	3.5	2.6	3.8	2.7	4.1	2.8	4.2	2.9
	91.4	2.4	1.8	2.6	2.0	3.2	2.6	3.5	2.6	3.8	2.7	4.0	2.8	4.2	2.8
	95.0	2.4	1.8	2.6	2.0	3.2	2.6	3.5	2.6	3.8	2.7	4.0	2.8	4.1	2.8
	98.6	2.4	1.8	2.6	2.0	3.2	2.6	3.5	2.6	3.8	2.8	3.9	2.8	4.1	2.8
	102.2	2.4	1.8	2.6	2.0	3.2	2.6	3.5	2.6	3.7	2.7	3.9	2.8	4.0	2.6
104.0	2.4	1.8	2.6	2.0	3.2	2.6	3.5	2.6	3.7	2.7	3.8	2.8	3.9	2.7	
109.4	2.4	1.8	2.6	2.0	3.2	2.6	3.5	2.6	3.6	2.7	3.8	2.8	3.9	2.7	

# DC INVERTER MULTI VRF INDOOR UNIT TECHNICAL SALES GUIDE

Cooling Capacity (kBtu/h)	Outdoor temperature (°FDB)	Indoor temperature (°FWB/°FDB)													
		57.2°FWB		60.8°FWB		64.4°FWB		66.2°FWB		68.0°FWB		71.6°FWB		75.2°FWB	
		68.0°FDB		73.4°FDB		78.8°FDB		80.6°FDB		82.4°FDB		86.0°FDB		89.6°FDB	
		TC	SC	TC	SC	TC	SC	TC	SC	TC	SC	TC	SC	TC	SC
15	50.0	3.0	2.3	3.2	2.5	4.0	3.2	4.4	3.3	4.8	3.4	5.4	3.5	5.9	3.8
	53.6	3.0	2.3	3.2	2.5	4.0	3.2	4.4	3.3	4.8	3.4	5.4	3.5	5.9	3.8
	57.2	3.0	2.3	3.2	2.5	4.0	3.2	4.4	3.3	4.8	3.4	5.4	3.5	5.9	3.8
	60.8	3.0	2.3	3.2	2.5	4.0	3.2	4.4	3.3	4.8	3.4	5.4	3.5	5.9	3.8
	64.4	3.0	2.3	3.2	2.5	4.0	3.2	4.4	3.3	4.8	3.4	5.4	3.5	5.9	3.8
	68.0	3.0	2.3	3.2	2.5	4.0	3.2	4.4	3.3	4.8	3.4	5.4	3.5	5.9	3.9
	69.8	3.0	2.3	3.2	2.5	4.0	3.2	4.4	3.3	4.8	3.4	5.4	3.5	5.7	3.8
	73.4	3.0	2.3	3.2	2.5	4.0	3.2	4.4	3.3	4.8	3.4	5.4	3.5	5.6	3.7
	77.0	3.0	2.3	3.2	2.5	4.0	3.2	4.4	3.3	4.8	3.4	5.3	3.6	5.5	3.7
	80.6	3.0	2.3	3.2	2.5	4.0	3.2	4.4	3.3	4.8	3.4	5.2	3.6	5.5	3.7
	84.2	3.0	2.3	3.2	2.5	4.0	3.2	4.4	3.3	4.8	3.4	5.1	3.6	5.4	3.7
	87.8	3.0	2.3	3.2	2.5	4.0	3.2	4.4	3.3	4.8	3.4	5.1	3.6	5.3	3.6
	91.4	3.0	2.3	3.2	2.5	4.0	3.2	4.4	3.3	4.8	3.4	5.1	3.5	5.2	3.6
	95.0	3.0	2.3	3.2	2.5	4.0	3.2	4.4	3.3	4.8	3.4	5.0	3.6	5.2	3.6
	98.6	3.0	2.3	3.2	2.5	4.0	3.2	4.4	3.3	4.8	3.5	4.9	3.5	5.1	3.5
	102.2	3.0	2.3	3.2	2.5	4.0	3.2	4.4	3.3	4.7	3.4	4.8	3.5	5.0	3.3
104.0	3.0	2.3	3.2	2.5	4.0	3.2	4.4	3.3	4.6	3.4	4.8	3.5	4.9	3.4	
109.4	3.0	2.3	3.2	2.5	4.0	3.2	4.4	3.3	4.5	3.4	4.8	3.5	4.8	3.4	
18	50.0	3.6	2.7	3.9	3.0	4.9	3.9	5.3	4.0	5.7	4.1	6.5	4.2	7.1	4.6
	53.6	3.6	2.7	3.9	3.0	4.9	3.9	5.3	4.0	5.7	4.1	6.5	4.2	7.1	4.6
	57.2	3.6	2.7	3.9	3.0	4.9	3.9	5.3	4.0	5.7	4.1	6.5	4.2	7.1	4.6
	60.8	3.6	2.7	3.9	3.0	4.9	3.9	5.3	4.0	5.7	4.1	6.5	4.2	7.1	4.6
	64.4	3.6	2.7	3.9	3.0	4.9	3.9	5.3	4.0	5.7	4.1	6.5	4.2	7.1	4.6
	68.0	3.6	2.7	3.9	3.0	4.9	3.9	5.3	4.0	5.7	4.1	6.5	4.2	7.0	4.7
	69.8	3.6	2.7	3.9	3.0	4.9	3.9	5.3	4.0	5.7	4.1	6.5	4.2	6.9	4.5
	73.4	3.6	2.7	3.9	3.0	4.9	3.9	5.3	4.0	5.7	4.1	6.5	4.2	6.8	4.5
	77.0	3.6	2.7	3.9	3.0	4.9	3.9	5.3	4.0	5.7	4.1	6.4	4.3	6.7	4.5
	80.6	3.6	2.7	3.9	3.0	4.9	3.9	5.3	4.0	5.7	4.1	6.3	4.3	6.6	4.4
	84.2	3.6	2.7	3.9	3.0	4.9	3.9	5.3	4.0	5.7	4.1	6.2	4.3	6.5	4.4
	87.8	3.6	2.7	3.9	3.0	4.9	3.9	5.3	4.0	5.7	4.1	6.1	4.3	6.4	4.4
	91.4	3.6	2.7	3.9	3.0	4.9	3.9	5.3	4.0	5.7	4.1	6.1	4.3	6.3	4.3
	95.0	3.6	2.7	3.9	3.0	4.9	3.9	5.3	4.0	5.7	4.1	6.0	4.3	6.3	4.3
	98.6	3.6	2.7	3.9	3.0	4.9	3.9	5.3	4.0	5.7	4.2	5.9	4.3	6.1	4.2
	102.2	3.6	2.7	3.9	3.0	4.9	3.9	5.3	4.0	5.7	4.1	5.8	4.3	6.0	4.0
104.0	3.6	2.7	3.9	3.0	4.9	3.9	5.3	4.0	5.6	4.1	5.8	4.2	5.9	4.2	
109.4	3.6	2.7	3.9	3.0	4.9	3.9	5.3	4.0	5.5	4.0	5.7	4.2	5.8	4.1	

Cooling Capacity (kBtu/h)	Outdoor temperature (°FDB)	Indoor temperature (°FWB/°FDB)													
		57.2°FWB		60.8°FWB		64.4°FWB		66.2°FWB		68.0°FWB		71.6°FWB		75.2°FWB	
		68.0°FDB		73.4°FDB		78.8°FDB		80.6°FDB		82.4°FDB		86.0°FDB		89.6°FDB	
		TC	SC	TC	SC	TC	SC	TC	SC	TC	SC	TC	SC	TC	SC
18 (Wall Mounted)	50.0	3.5	2.7	3.8	3.0	4.8	3.8	5.2	3.9	5.6	4.0	6.4	4.2	7.0	4.5
	53.6	3.5	2.7	3.8	3.0	4.8	3.8	5.2	3.9	5.6	4.0	6.4	4.2	7.0	4.5
	57.2	3.5	2.7	3.8	3.0	4.8	3.8	5.2	3.9	5.6	4.0	6.4	4.2	7.0	4.5
	60.8	3.5	2.7	3.8	3.0	4.8	3.8	5.2	3.9	5.6	4.0	6.4	4.2	7.0	4.5
	64.4	3.5	2.7	3.8	3.0	4.8	3.8	5.2	3.9	5.6	4.0	6.4	4.2	7.0	4.5
	68.0	3.5	2.7	3.8	3.0	4.8	3.8	5.2	3.9	5.6	4.0	6.4	4.2	6.9	4.6
	69.8	3.5	2.7	3.8	3.0	4.8	3.8	5.2	3.9	5.6	4.0	6.4	4.2	6.8	4.5
	73.4	3.5	2.7	3.8	3.0	4.8	3.8	5.2	3.9	5.6	4.0	6.4	4.2	6.7	4.4
	77.0	3.5	2.7	3.8	3.0	4.8	3.8	5.2	3.9	5.6	4.0	6.3	4.2	6.6	4.4
	80.6	3.5	2.7	3.8	3.0	4.8	3.8	5.2	3.9	5.6	4.0	6.2	4.2	6.5	4.4
	84.2	3.5	2.7	3.8	3.0	4.8	3.8	5.2	3.9	5.6	4.0	6.1	4.2	6.4	4.3
	87.8	3.5	2.7	3.8	3.0	4.8	3.8	5.2	3.9	5.6	4.0	6.0	4.2	6.3	4.3
	91.4	3.5	2.7	3.8	3.0	4.8	3.8	5.2	3.9	5.6	4.0	6.0	4.2	6.2	4.2
	95.0	3.5	2.7	3.8	3.0	4.8	3.8	5.2	3.9	5.6	4.0	5.9	4.2	6.1	4.2
	98.6	3.5	2.7	3.8	3.0	4.8	3.8	5.2	3.9	5.6	4.1	5.8	4.2	6.0	4.2
	102.2	3.5	2.7	3.8	3.0	4.8	3.8	5.2	3.9	5.6	4.1	5.7	4.2	5.9	3.9
104.0	3.5	2.7	3.8	3.0	4.8	3.8	5.2	3.9	5.5	4.0	5.7	4.1	5.8	4.1	
109.4	3.5	2.7	3.8	3.0	4.8	3.8	5.2	3.9	5.4	4.0	5.6	4.1	5.7	4.0	
22	50.0	4.3	3.3	4.6	3.6	5.8	4.6	6.3	4.7	6.8	4.8	7.7	5.0	8.4	5.5
	53.6	4.3	3.3	4.6	3.6	5.8	4.6	6.3	4.7	6.8	4.8	7.7	5.0	8.4	5.5
	57.2	4.3	3.3	4.6	3.6	5.8	4.6	6.3	4.7	6.8	4.8	7.7	5.0	8.4	5.5
	60.8	4.3	3.3	4.6	3.6	5.8	4.6	6.3	4.7	6.8	4.8	7.7	5.0	8.4	5.5
	64.4	4.3	3.3	4.6	3.6	5.8	4.6	6.3	4.7	6.8	4.8	7.7	5.0	8.4	5.5
	68.0	4.3	3.3	4.6	3.6	5.8	4.6	6.3	4.7	6.8	4.8	7.7	5.0	8.4	5.5
	69.8	4.3	3.3	4.6	3.6	5.8	4.6	6.3	4.7	6.8	4.8	7.7	5.0	8.2	5.4
	73.4	4.3	3.3	4.6	3.6	5.8	4.6	6.3	4.7	6.8	4.8	7.7	5.0	8.1	5.3
	77.0	4.3	3.3	4.6	3.6	5.8	4.6	6.3	4.7	6.8	4.8	7.6	5.1	7.9	5.3
	80.6	4.3	3.3	4.6	3.6	5.8	4.6	6.3	4.7	6.8	4.8	7.5	5.1	7.9	5.3
	84.2	4.3	3.3	4.6	3.6	5.8	4.6	6.3	4.7	6.8	4.8	7.4	5.1	7.7	5.3
	87.8	4.3	3.3	4.6	3.6	5.8	4.6	6.3	4.7	6.8	4.8	7.3	5.1	7.6	5.2
	91.4	4.3	3.3	4.6	3.6	5.8	4.6	6.3	4.7	6.8	4.8	7.2	5.1	7.5	5.1
	95.0	4.3	3.3	4.6	3.6	5.8	4.6	6.3	4.7	6.8	4.8	7.2	5.1	7.4	5.1
	98.6	4.3	3.3	4.6	3.6	5.8	4.6	6.3	4.7	6.8	5.0	7.1	5.1	7.3	5.0
	102.2	4.3	3.3	4.6	3.6	5.8	4.6	6.3	4.7	6.7	4.9	6.9	5.1	7.2	4.8
104.0	4.3	3.3	4.6	3.6	5.8	4.6	6.3	4.7	6.6	4.9	6.9	5.0	7.1	4.9	
109.4	4.3	3.3	4.6	3.6	5.8	4.6	6.3	4.7	6.5	4.8	6.8	5.0	6.9	4.9	



# DC INVERTER MULTI VRF INDOOR UNIT TECHNICAL SALES GUIDE

Cooling Capacity (kBtu/h)	Outdoor temperature (°FDB)	Indoor temperature (°FWB/°FDB)													
		57.2°FWB		60.8°FWB		64.4°FWB		66.2°FWB		68.0°FWB		71.6°FWB		75.2°FWB	
		68.0°FDB		73.4°FDB		78.8°FDB		80.6°FDB		82.4°FDB		86.0°FDB		89.6°FDB	
		TC	SC	TC	SC	TC	SC	TC	SC	TC	SC	TC	SC	TC	SC
24	50.0	4.8	3.6	5.1	4.0	6.4	5.2	7.0	5.3	7.6	5.4	8.6	5.6	9.4	6.1
	53.6	4.8	3.6	5.1	4.0	6.4	5.2	7.0	5.3	7.6	5.4	8.6	5.6	9.4	6.1
	57.2	4.8	3.6	5.1	4.0	6.4	5.2	7.0	5.3	7.6	5.4	8.6	5.6	9.4	6.1
	60.8	4.8	3.6	5.1	4.0	6.4	5.2	7.0	5.3	7.6	5.4	8.6	5.6	9.4	6.1
	64.4	4.8	3.6	5.1	4.0	6.4	5.2	7.0	5.3	7.6	5.4	8.6	5.6	9.4	6.1
	68.0	4.8	3.6	5.1	4.0	6.4	5.2	7.0	5.3	7.6	5.4	8.6	5.6	9.3	6.1
	69.8	4.8	3.6	5.1	4.0	6.4	5.2	7.0	5.3	7.6	5.4	8.6	5.6	9.1	6.0
	73.4	4.8	3.6	5.1	4.0	6.4	5.2	7.0	5.3	7.6	5.4	8.6	5.6	9.0	5.9
	77.0	4.8	3.6	5.1	4.0	6.4	5.2	7.0	5.3	7.6	5.4	8.5	5.7	8.8	5.9
	80.6	4.8	3.6	5.1	4.0	6.4	5.2	7.0	5.3	7.6	5.4	8.3	5.7	8.8	5.9
	84.2	4.8	3.6	5.1	4.0	6.4	5.2	7.0	5.3	7.6	5.4	8.2	5.7	8.6	5.9
	87.8	4.8	3.6	5.1	4.0	6.4	5.2	7.0	5.3	7.6	5.4	8.1	5.7	8.5	5.8
	91.4	4.8	3.6	5.1	4.0	6.4	5.2	7.0	5.3	7.6	5.4	8.1	5.6	8.3	5.7
	95.0	4.8	3.6	5.1	4.0	6.4	5.2	7.0	5.3	7.6	5.4	8.0	5.7	8.3	5.7
	98.6	4.8	3.6	5.1	4.0	6.4	5.2	7.0	5.3	7.6	5.5	7.8	5.6	8.1	5.6
	102.2	4.8	3.6	5.1	4.0	6.4	5.2	7.0	5.3	7.5	5.5	7.7	5.6	8.0	5.3
104.0	4.8	3.6	5.1	4.0	6.4	5.2	7.0	5.3	7.4	5.4	7.6	5.6	7.8	5.5	
109.4	4.8	3.6	5.1	4.0	6.4	5.2	7.0	5.3	7.2	5.3	7.6	5.5	7.7	5.4	
30	50.0	6.0	4.5	6.4	5.0	8.1	6.5	8.8	6.6	9.5	6.7	10.8	7.0	11.8	7.7
	53.6	6.0	4.5	6.4	5.0	8.1	6.5	8.8	6.6	9.5	6.7	10.8	7.0	11.8	7.7
	57.2	6.0	4.5	6.4	5.0	8.1	6.5	8.8	6.6	9.5	6.7	10.8	7.0	11.8	7.7
	60.8	6.0	4.5	6.4	5.0	8.1	6.5	8.8	6.6	9.5	6.7	10.8	7.0	11.8	7.7
	64.4	6.0	4.5	6.4	5.0	8.1	6.5	8.8	6.6	9.5	6.7	10.8	7.0	11.8	7.7
	68.0	6.0	4.5	6.4	5.0	8.1	6.5	8.8	6.6	9.5	6.7	10.8	7.0	11.7	7.7
	69.8	6.0	4.5	6.4	5.0	8.1	6.5	8.8	6.6	9.5	6.7	10.8	7.0	11.4	7.6
	73.4	6.0	4.5	6.4	5.0	8.1	6.5	8.8	6.6	9.5	6.7	10.8	7.0	11.3	7.4
	77.0	6.0	4.5	6.4	5.0	8.1	6.5	8.8	6.6	9.5	6.7	10.6	7.1	11.1	7.4
	80.6	6.0	4.5	6.4	5.0	8.1	6.5	8.8	6.6	9.5	6.7	10.5	7.1	11.0	7.4
	84.2	6.0	4.5	6.4	5.0	8.1	6.5	8.8	6.6	9.5	6.7	10.3	7.1	10.8	7.4
	87.8	6.0	4.5	6.4	5.0	8.1	6.5	8.8	6.6	9.5	6.7	10.2	7.1	10.6	7.2
	91.4	6.0	4.5	6.4	5.0	8.1	6.5	8.8	6.6	9.5	6.7	10.1	7.1	10.5	7.1
	95.0	6.0	4.5	6.4	5.0	8.1	6.5	8.8	6.6	9.5	6.7	10.0	7.1	10.4	7.2
	98.6	6.0	4.5	6.4	5.0	8.1	6.5	8.8	6.6	9.5	6.9	9.9	7.1	10.2	7.0
	102.2	6.0	4.5	6.4	5.0	8.1	6.5	8.8	6.6	9.4	6.9	9.7	7.1	10.0	6.6
104.0	6.0	4.5	6.4	5.0	8.1	6.5	8.8	6.6	9.2	6.8	9.6	7.0	9.9	6.9	
109.4	6.0	4.5	6.4	5.0	8.1	6.5	8.8	6.6	9.1	6.7	9.5	6.9	9.7	6.8	

Cooling Capacity (kBtu/h)	Outdoor temperature (°FDB)	Indoor temperature (°FWB/°FDB)													
		57.2°FWB		60.8°FWB		64.4°FWB		66.2°FWB		68.0°FWB		71.6°FWB		75.2°FWB	
		68.0°FDB		73.4°FDB		78.8°FDB		80.6°FDB		82.4°FDB		86.0°FDB		89.6°FDB	
		TC	SC	TC	SC	TC	SC	TC	SC	TC	SC	TC	SC	TC	SC
36	50.0	7.2	5.5	7.7	6.0	9.8	7.8	10.6	8.0	11.4	8.1	13.0	8.5	14.2	9.2
	53.6	7.2	5.5	7.7	6.0	9.8	7.8	10.6	8.0	11.4	8.1	13.0	8.5	14.2	9.2
	57.2	7.2	5.5	7.7	6.0	9.8	7.8	10.6	8.0	11.4	8.1	13.0	8.5	14.2	9.2
	60.8	7.2	5.5	7.7	6.0	9.8	7.8	10.6	8.0	11.4	8.1	13.0	8.5	14.2	9.2
	64.4	7.2	5.5	7.7	6.0	9.8	7.8	10.6	8.0	11.4	8.1	13.0	8.5	14.2	9.2
	68.0	7.2	5.5	7.7	6.0	9.8	7.8	10.6	8.0	11.4	8.1	13.0	8.5	14.1	9.3
	69.8	7.2	5.5	7.7	6.0	9.8	7.8	10.6	8.0	11.4	8.1	13.0	8.5	13.8	9.1
	73.4	7.2	5.5	7.7	6.0	9.8	7.8	10.6	8.0	11.4	8.1	13.0	8.5	13.6	9.0
	77.0	7.2	5.5	7.7	6.0	9.8	7.8	10.6	8.0	11.4	8.1	12.8	8.6	13.4	8.9
	80.6	7.2	5.5	7.7	6.0	9.8	7.8	10.6	8.0	11.4	8.1	12.6	8.6	13.3	8.9
	84.2	7.2	5.5	7.7	6.0	9.8	7.8	10.6	8.0	11.4	8.1	12.4	8.6	13.0	8.9
	87.8	7.2	5.5	7.7	6.0	9.8	7.8	10.6	8.0	11.4	8.1	12.3	8.6	12.8	8.7
	91.4	7.2	5.5	7.7	6.0	9.8	7.8	10.6	8.0	11.4	8.1	12.2	8.5	12.6	8.6
	95.0	7.2	5.5	7.7	6.0	9.8	7.8	10.6	8.0	11.4	8.1	12.1	8.6	12.5	8.6
	98.6	7.2	5.5	7.7	6.0	9.8	7.8	10.6	8.0	11.4	8.4	11.9	8.5	12.3	8.5
	102.2	7.2	5.5	7.7	6.0	9.8	7.8	10.6	8.0	11.3	8.3	11.7	8.5	12.1	8.0
104.0	7.2	5.5	7.7	6.0	9.8	7.8	10.6	8.0	11.1	8.2	11.6	8.4	11.9	8.3	
109.4	7.2	5.5	7.7	6.0	9.8	7.8	10.6	8.0	10.9	8.1	11.4	8.4	11.7	8.2	
42	50.0	8.4	6.4	9.0	7.0	11.3	9.1	12.3	9.2	13.3	9.4	15.1	9.8	16.5	10.7
	53.6	8.4	6.4	9.0	7.0	11.3	9.1	12.3	9.2	13.3	9.4	15.1	9.8	16.5	10.7
	57.2	8.4	6.4	9.0	7.0	11.3	9.1	12.3	9.2	13.3	9.4	15.1	9.8	16.5	10.7
	60.8	8.4	6.4	9.0	7.0	11.3	9.1	12.3	9.2	13.3	9.4	15.1	9.8	16.5	10.7
	64.4	8.4	6.4	9.0	7.0	11.3	9.1	12.3	9.2	13.3	9.4	15.1	9.8	16.5	10.7
	68.0	8.4	6.4	9.0	7.0	11.3	9.1	12.3	9.2	13.3	9.4	15.1	9.8	16.4	10.8
	69.8	8.4	6.4	9.0	7.0	11.3	9.1	12.3	9.2	13.3	9.4	15.1	9.8	16.0	10.6
	73.4	8.4	6.4	9.0	7.0	11.3	9.1	12.3	9.2	13.3	9.4	15.1	9.8	15.7	10.4
	77.0	8.4	6.4	9.0	7.0	11.3	9.1	12.3	9.2	13.3	9.4	14.9	10.0	15.5	10.4
	80.6	8.4	6.4	9.0	7.0	11.3	9.1	12.3	9.2	13.3	9.4	14.6	9.9	15.4	10.3
	84.2	8.4	6.4	9.0	7.0	11.3	9.1	12.3	9.2	13.3	9.4	14.4	9.9	15.1	10.3
	87.8	8.4	6.4	9.0	7.0	11.3	9.1	12.3	9.2	13.3	9.4	14.3	10.0	14.9	10.1
	91.4	8.4	6.4	9.0	7.0	11.3	9.1	12.3	9.2	13.3	9.4	14.1	9.9	14.6	10.0
	95.0	8.4	6.4	9.0	7.0	11.3	9.1	12.3	9.2	13.3	9.4	14.0	10.0	14.5	10.0
	98.6	8.4	6.4	9.0	7.0	11.3	9.1	12.3	9.2	13.3	9.7	13.8	9.9	14.3	9.8
	102.2	8.4	6.4	9.0	7.0	11.3	9.1	12.3	9.2	13.2	9.6	13.5	9.9	14.0	9.3
104.0	8.4	6.4	9.0	7.0	11.3	9.1	12.3	9.2	12.9	9.6	13.4	9.8	13.8	9.6	
109.4	8.4	6.4	9.0	7.0	11.3	9.1	12.3	9.2	12.7	9.4	13.3	9.7	13.5	9.5	

# DC INVERTER MULTI VRF INDOOR UNIT TECHNICAL SALES GUIDE

Cooling Capacity (kBtu/h)	Outdoor temperature (°FDB)	Indoor temperature (°FWB/°FDB)													
		57.2°FWB		60.8°FWB		64.4°FWB		66.2°FWB		68.0°FWB		71.6°FWB		75.2°FWB	
		68.0°FDB		73.4°FDB		78.8°FDB		80.6°FDB		82.4°FDB		86.0°FDB		89.6°FDB	
		TC	SC	TC	SC	TC	SC	TC	SC	TC	SC	TC	SC	TC	SC
48	50.0	9.6	7.3	10.3	8.0	13.0	10.4	14.1	10.6	15.2	10.8	17.3	11.3	18.9	12.3
	53.6	9.6	7.3	10.3	8.0	13.0	10.4	14.1	10.6	15.2	10.8	17.3	11.3	18.9	12.3
	57.2	9.6	7.3	10.3	8.0	13.0	10.4	14.1	10.6	15.2	10.8	17.3	11.3	18.9	12.3
	60.8	9.6	7.3	10.3	8.0	13.0	10.4	14.1	10.6	15.2	10.8	17.3	11.3	18.9	12.3
	64.4	9.6	7.3	10.3	8.0	13.0	10.4	14.1	10.6	15.2	10.8	17.3	11.3	18.9	12.3
	68.0	9.6	7.3	10.3	8.0	13.0	10.4	14.1	10.6	15.2	10.8	17.3	11.3	18.8	12.4
	69.8	9.6	7.3	10.3	8.0	13.0	10.4	14.1	10.6	15.2	10.8	17.3	11.3	18.3	12.1
	73.4	9.6	7.3	10.3	8.0	13.0	10.4	14.1	10.6	15.2	10.8	17.3	11.3	18.0	11.9
	77.0	9.6	7.3	10.3	8.0	13.0	10.4	14.1	10.6	15.2	10.8	17.1	11.4	17.8	11.9
	80.6	9.6	7.3	10.3	8.0	13.0	10.4	14.1	10.6	15.2	10.8	16.8	11.4	17.6	11.8
	84.2	9.6	7.3	10.3	8.0	13.0	10.4	14.1	10.6	15.2	10.8	16.5	11.4	17.3	11.8
	87.8	9.6	7.3	10.3	8.0	13.0	10.4	14.1	10.6	15.2	10.8	16.4	11.4	17.1	11.6
	91.4	9.6	7.3	10.3	8.0	13.0	10.4	14.1	10.6	15.2	10.8	16.2	11.4	16.8	11.4
	95.0	9.6	7.3	10.3	8.0	13.0	10.4	14.1	10.6	15.2	10.8	16.1	11.4	16.6	11.5
	98.6	9.6	7.3	10.3	8.0	13.0	10.4	14.1	10.6	15.2	11.1	15.8	11.4	16.4	11.3
	102.2	9.6	7.3	10.3	8.0	13.0	10.4	14.1	10.6	15.1	11.0	15.5	11.3	16.1	10.6
104.0	9.6	7.3	10.3	8.0	13.0	10.4	14.1	10.6	14.8	11.0	15.4	11.2	15.8	11.1	
109.4	9.6	7.3	10.3	8.0	13.0	10.4	14.1	10.6	14.5	10.7	15.2	11.1	15.5	10.9	
54	10	10.9	8.3	11.7	9.1	14.7	11.8	16	12	17.3	12.3	19.7	12.8	21.4	13.9
	12	10.9	8.3	11.7	9.1	14.7	11.8	16	12	17.3	12.3	19.7	12.8	21.4	13.9
	14	10.9	8.3	11.7	9.1	14.7	11.8	16	12	17.3	12.3	19.7	12.8	21.4	13.9
	16	10.9	8.3	11.7	9.1	14.7	11.8	16	12	17.3	12.3	19.7	12.8	21.4	13.9
	18	10.9	8.3	11.7	9.1	14.7	11.8	16	12	17.3	12.3	19.7	12.8	21.4	13.9
	20	10.9	8.3	11.7	9.1	14.7	11.8	16	12	17.3	12.3	19.7	12.8	21.3	14
	21	10.9	8.3	11.7	9.1	14.7	11.8	16	12	17.3	12.3	19.7	12.8	20.8	13.7
	23	10.9	8.3	11.7	9.1	14.7	11.8	16	12	17.3	12.3	19.7	12.8	20.5	13.5
	25	10.9	8.3	11.7	9.1	14.7	11.8	16	12	17.3	12.3	19.4	13	20.2	13.5
	27	10.9	8.3	11.7	9.1	14.7	11.8	16	12	17.3	12.3	19	12.9	20	13.4
	29	10.9	8.3	11.7	9.1	14.7	11.8	16	12	17.3	12.3	18.7	12.9	19.7	13.4
	31	10.9	8.3	11.7	9.1	14.7	11.8	16	12	17.3	12.3	18.6	13	19.4	13.2
	33	10.9	8.3	11.7	9.1	14.7	11.8	16	12	17.3	12.3	18.4	12.9	19	12.9
	35	10.9	8.3	11.7	9.1	14.7	11.8	16	12	17.3	12.3	18.2	13	18.9	13
	37	10.9	8.3	11.7	9.1	14.7	11.8	16	12	17.3	12.6	17.9	12.9	18.6	12.8
	39	10.9	8.3	11.7	9.1	14.7	11.8	16	12	17.1	12.5	17.6	12.8	18.2	12.1
40	10.9	8.3	11.7	9.1	14.7	11.8	16	12	16.8	12.4	17.4	12.7	17.9	12.5	
43	10.9	8.3	11.7	9.1	14.7	11.8	16	12	16.5	12.2	17.3	12.6	17.6	12.3	

Cooling Capacity (kBtu/h)	Outdoor temperature (°FDB)	Indoor temperature (°FWB/°FDB)													
		57.2°FWB		60.8°FWB		64.4°FWB		66.2°FWB		68.0°FWB		71.6°FWB		75.2°FWB	
		68.0°FDB		73.4°FDB		78.8°FDB		80.6°FDB		82.4°FDB		86.0°FDB		89.6°FDB	
		TC	SC	TC	SC	TC	SC	TC	SC	TC	SC	TC	SC	TC	SC
72	50.0	13.7	10.4	14.7	11.5	18.6	14.9	20.2	15.2	21.8	15.5	24.8	16.1	27.1	17.6
	53.6	13.7	10.4	14.7	11.5	18.6	14.9	20.2	15.2	21.8	15.5	24.8	16.1	27.1	17.6
	57.2	13.7	10.4	14.7	11.5	18.6	14.9	20.2	15.2	21.8	15.5	24.8	16.1	27.1	17.6
	60.8	13.7	10.4	14.7	11.5	18.6	14.9	20.2	15.2	21.8	15.5	24.8	16.1	27.1	17.6
	64.4	13.7	10.4	14.7	11.5	18.6	14.9	20.2	15.2	21.8	15.5	24.8	16.1	27.1	17.6
	68.0	13.7	10.4	14.7	11.5	18.6	14.9	20.2	15.2	21.8	15.5	24.8	16.1	26.9	17.7
	69.8	13.7	10.4	14.7	11.5	18.6	14.9	20.2	15.2	21.8	15.5	24.8	16.1	26.3	17.3
	73.4	13.7	10.4	14.7	11.5	18.6	14.9	20.2	15.2	21.8	15.5	24.8	16.1	25.9	17.1
	77.0	13.7	10.4	14.7	11.5	18.6	14.9	20.2	15.2	21.8	15.5	24.4	16.4	25.5	17.1
	80.6	13.7	10.4	14.7	11.5	18.6	14.9	20.2	15.2	21.8	15.5	24.0	16.3	25.3	16.9
	84.2	13.7	10.4	14.7	11.5	18.6	14.9	20.2	15.2	21.8	15.5	23.6	16.3	24.8	16.9
	87.8	13.7	10.4	14.7	11.5	18.6	14.9	20.2	15.2	21.8	15.5	23.4	16.4	24.4	16.6
	91.4	13.7	10.4	14.7	11.5	18.6	14.9	20.2	15.2	21.8	15.5	23.2	16.3	24.0	16.3
	95.0	13.7	10.4	14.7	11.5	18.6	14.9	20.2	15.2	21.8	15.5	23.0	16.3	23.8	16.4
	98.6	13.7	10.4	14.7	11.5	18.6	14.9	20.2	15.2	21.8	15.9	22.6	16.3	23.4	16.2
	102.2	13.7	10.4	14.7	11.5	18.6	14.9	20.2	15.2	21.6	15.8	22.2	16.2	23.0	15.2
104.0	13.7	10.4	14.7	11.5	18.6	14.9	20.2	15.2	21.2	15.7	22.0	16.1	22.6	15.8	
109.4	13.7	10.4	14.7	11.5	18.6	14.9	20.2	15.2	20.8	15.4	21.8	15.9	22.2	15.6	
96	50.0	18.4	14.0	19.7	15.4	24.8	19.9	27.0	20.3	29.2	20.7	33.2	21.6	36.2	23.5
	53.6	18.4	14.0	19.7	15.4	24.8	19.9	27.0	20.3	29.2	20.7	33.2	21.6	36.2	23.5
	57.2	18.4	14.0	19.7	15.4	24.8	19.9	27.0	20.3	29.2	20.7	33.2	21.6	36.2	23.5
	60.8	18.4	14.0	19.7	15.4	24.8	19.9	27.0	20.3	29.2	20.7	33.2	21.6	36.2	23.5
	64.4	18.4	14.0	19.7	15.4	24.8	19.9	27.0	20.3	29.2	20.7	33.2	21.6	36.2	23.5
	68.0	18.4	14.0	19.7	15.4	24.8	19.9	27.0	20.3	29.2	20.7	33.2	21.6	35.9	23.7
	69.8	18.4	14.0	19.7	15.4	24.8	19.9	27.0	20.3	29.2	20.7	33.2	21.6	35.1	23.2
	73.4	18.4	14.0	19.7	15.4	24.8	19.9	27.0	20.3	29.2	20.7	33.2	21.6	34.6	22.8
	77.0	18.4	14.0	19.7	15.4	24.8	19.9	27.0	20.3	29.2	20.7	32.7	21.9	34.0	22.8
	80.6	18.4	14.0	19.7	15.4	24.8	19.9	27.0	20.3	29.2	20.7	32.1	21.8	33.8	22.6
	84.2	18.4	14.0	19.7	15.4	24.8	19.9	27.0	20.3	29.2	20.7	31.6	21.8	33.2	22.6
	87.8	18.4	14.0	19.7	15.4	24.8	19.9	27.0	20.3	29.2	20.7	31.3	21.9	32.7	22.2
	91.4	18.4	14.0	19.7	15.4	24.8	19.9	27.0	20.3	29.2	20.7	31.1	21.7	32.1	21.8
	95.0	18.4	14.0	19.7	15.4	24.8	19.9	27.0	20.3	29.2	20.7	30.8	21.9	31.9	22.0
	98.6	18.4	14.0	19.7	15.4	24.8	19.9	27.0	20.3	29.2	21.3	30.2	21.8	31.3	21.6
	102.2	18.4	14.0	19.7	15.4	24.8	19.9	27.0	20.3	28.9	21.1	29.7	21.7	30.8	20.4
104.0	18.4	14.0	19.7	15.4	24.8	19.9	27.0	20.3	28.4	21.0	29.4	21.5	30.2	21.2	
109.4	18.4	14.0	19.7	15.4	24.8	19.9	27.0	20.3	27.8	20.6	29.2	21.3	29.7	20.8	

# DC INVERTER MULTI VRF INDOOR UNIT TECHNICAL SALES GUIDE

## Fresh air Processing

Cooling Capacity (kBtu/h)	Outdoor temperature (°FDB)	Indoor temperature (°FWB/°FDB)													
		57.2°FWB		60.8°FWB		64.4°FWB		66.2°FWB		68.0°FWB		71.6°FWB		75.2°FWB	
		68.0°FDB		73.4°FDB		78.8°FDB		80.6°FDB		82.4°FDB		86.0°FDB		89.6°FDB	
		TC	SC	TC	SC	TC	SC	TC	SC	TC	SC	TC	SC	TC	SC
72	10.0	14.3	10.9	15.4	12.0	19.4	15.5	21.1	15.8	22.8	16.2	26.0	16.9	28.3	18.4
	12.0	14.3	10.9	15.4	12.0	19.4	15.5	21.1	15.8	22.8	16.2	26.0	16.9	28.3	18.4
	14.0	14.3	10.9	15.4	12.0	19.4	15.5	21.1	15.8	22.8	16.2	26.0	16.9	28.3	18.4
	16.0	14.3	10.9	15.4	12.0	19.4	15.5	21.1	15.8	22.8	16.2	26.0	16.9	28.3	18.4
	18.0	14.3	10.9	15.4	12.0	19.4	15.5	21.1	15.8	22.8	16.2	26.0	16.9	28.3	18.4
	20.0	14.3	10.9	15.4	12.0	19.4	15.5	21.1	15.8	22.8	16.2	26.0	16.9	28.1	18.5
	21.0	14.3	10.9	15.4	12.0	19.4	15.5	21.1	15.8	22.8	16.2	26.0	16.9	27.4	18.1
	23.0	14.3	10.9	15.4	12.0	19.4	15.5	21.1	15.8	22.8	16.2	26.0	16.9	27.0	17.8
	25.0	14.3	10.9	15.4	12.0	19.4	15.5	21.1	15.8	22.8	16.2	25.5	17.1	26.6	17.8
	27.0	14.3	10.9	15.4	12.0	19.4	15.5	21.1	15.8	22.8	16.2	25.1	17.0	26.4	17.7
	29.0	14.3	10.9	15.4	12.0	19.4	15.5	21.1	15.8	22.8	16.2	24.7	17.0	26.0	17.6
	31.0	14.3	10.9	15.4	12.0	19.4	15.5	21.1	15.8	22.8	16.2	24.5	17.1	25.5	17.4
	33.0	14.3	10.9	15.4	12.0	19.4	15.5	21.1	15.8	22.8	16.2	24.3	17.0	25.1	17.1
	35.0	14.3	10.9	15.4	12.0	19.4	15.5	21.1	15.8	22.8	16.2	24.1	17.1	24.9	17.2
	37.0	14.3	10.9	15.4	12.0	19.4	15.5	21.1	15.8	22.8	16.6	23.6	17.0	24.5	16.9
	39.0	14.3	10.9	15.4	12.0	19.4	15.5	21.1	15.8	22.6	16.5	23.2	16.9	24.1	15.9
40.0	14.3	10.9	15.4	12.0	19.4	15.5	21.1	15.8	22.2	16.4	23.0	16.8	23.6	16.5	
43.0	14.3	10.9	15.4	12.0	19.4	15.5	21.1	15.8	21.7	16.1	22.8	16.6	23.2	16.2	
96	10.0	19.1	14.5	20.5	16.0	25.9	20.7	28.14	21.1	30.4	21.6	34.6	22.5	37.7	24.5
	12.0	19.1	14.5	20.5	16.0	25.9	20.7	28.14	21.1	30.4	21.6	34.6	22.5	37.7	24.5
	14.0	19.1	14.5	20.5	16.0	25.9	20.7	28.14	21.1	30.4	21.6	34.6	22.5	37.7	24.5
	16.0	19.1	14.5	20.5	16.0	25.9	20.7	28.14	21.1	30.4	21.6	34.6	22.5	37.7	24.5
	18.0	19.1	14.5	20.5	16.0	25.9	20.7	28.14	21.1	30.4	21.6	34.6	22.5	37.7	24.5
	20.0	19.1	14.5	20.5	16.0	25.9	20.7	28.14	21.1	30.4	21.6	34.6	22.5	37.4	24.7
	21.0	19.1	14.5	20.5	16.0	25.9	20.7	28.14	21.1	30.4	21.6	34.6	22.5	36.6	24.1
	23.0	19.1	14.5	20.5	16.0	25.9	20.7	28.14	21.1	30.4	21.6	34.6	22.5	36.0	23.8
	25.0	19.1	14.5	20.5	16.0	25.9	20.7	28.14	21.1	30.4	21.6	34.0	22.8	35.5	23.8
	27.0	19.1	14.5	20.5	16.0	25.9	20.7	28.14	21.1	30.4	21.6	33.4	22.7	35.2	23.6
	29.0	19.1	14.5	20.5	16.0	25.9	20.7	28.14	21.1	30.4	21.6	32.9	22.7	34.6	23.5
	31.0	19.1	14.5	20.5	16.0	25.9	20.7	28.14	21.1	30.4	21.6	32.6	22.8	34.0	23.2
	33.0	19.1	14.5	20.5	16.0	25.9	20.7	28.14	21.1	30.4	21.6	32.4	22.7	33.5	22.8
	35.0	19.1	14.5	20.5	16.0	25.9	20.7	28.14	21.1	30.4	21.6	32.1	22.8	33.2	22.9
	37.0	19.1	14.5	20.5	16.0	25.9	20.7	28.14	21.1	30.4	22.2	31.5	22.7	32.6	22.5
	39.0	19.1	14.5	20.5	16.0	25.9	20.7	28.14	21.1	30.1	22.0	31.0	22.6	32.1	21.2
40.0	19.1	14.5	20.5	16.0	25.9	20.7	28.14	21.1	29.5	21.9	30.7	22.4	31.5	22.1	
43.0	19.1	14.5	20.5	16.0	25.9	20.7	28.14	21.1	29.0	21.4	30.4	22.2	31.0	21.7	

## ➔ 4.2 Heating Capacity Correction

Heating Capacity (kBtu/h)	Outdoor temperature		Indoor temperature <sup>°FDB</sup>						
			60.8	64.4	68.0	69.8	71.6	75.2	78.8
			TC	TC	TC	TC	TC	TC	TC
	°FDB	°FWB	kW	kW	kW	kW	kW	kW	kW
05	-19.7	-20	1.06	1.06	1.06	1.06	1.06	1.06	1.05
	-14.7	-15.0	1.22	1.22	1.22	1.22	1.22	1.22	1.19
	-12.6	-13.0	1.29	1.29	1.29	1.29	1.29	1.29	1.25
	-10.5	-11.0	1.37	1.37	1.37	1.37	1.37	1.37	1.34
	-9.5	-10.0	1.37	1.37	1.37	1.37	1.37	1.37	1.33
	-8.5	-9.1	1.44	1.44	1.44	1.44	1.44	1.44	1.40
	-7.0	-7.6	1.44	1.44	1.44	1.44	1.44	1.44	1.40
	-5.0	-5.6	1.52	1.52	1.52	1.52	1.52	1.52	1.52
	-3.0	-3.7	1.60	1.60	1.60	1.60	1.60	1.60	1.52
	0.0	-0.7	1.67	1.67	1.67	1.67	1.67	1.60	1.52
	3.0	2.2	1.82	1.82	1.82	1.82	1.75	1.60	1.52
	5.0	4.1	1.82	1.82	1.82	1.82	1.75	1.60	1.52
	7.0	6.0	1.90	1.90	1.90	1.82	1.75	1.60	1.52
	9.0	7.9	1.98	1.98	1.90	1.82	1.75	1.60	1.52
	11.0	9.8	2.05	2.05	1.90	1.82	1.75	1.60	1.52
13.0	11.8	2.13	2.05	1.90	1.82	1.75	1.60	1.52	
15.0	13.7	2.20	2.05	1.90	1.82	1.75	1.60	1.52	
07	-3.46	-4.00	1.4	1.4	1.4	1.4	1.4	1.4	1.4
	5.54	5.00	1.6	1.6	1.6	1.6	1.6	1.6	1.6
	9.32	8.60	1.7	1.7	1.7	1.7	1.7	1.7	1.6
	13.1	12.2	1.8	1.8	1.8	1.8	1.8	1.8	1.8
	14.9	14.0	1.8	1.8	1.8	1.8	1.8	1.8	1.8
	16.7	15.6	1.9	1.9	1.9	1.9	1.9	1.9	1.8
	19.4	18.3	1.9	1.9	1.9	1.9	1.9	1.9	1.8
	23.0	21.9	2.0	2.0	2.0	2.0	2.0	2.0	2.0
	26.6	25.3	2.1	2.1	2.1	2.1	2.1	2.1	2.0
	32.0	30.7	2.2	2.2	2.2	2.2	2.2	2.1	2.0
	37.4	36.0	2.4	2.4	2.4	2.4	2.3	2.1	2.0
	41.0	39.4	2.4	2.4	2.4	2.4	2.3	2.1	2.0
	44.6	42.8	2.5	2.5	2.5	2.4	2.3	2.1	2.0
	48.2	46.2	2.6	2.6	2.5	2.4	2.3	2.1	2.0
	51.8	49.6	2.7	2.7	2.5	2.4	2.3	2.1	2.0
55.4	53.2	2.8	2.7	2.5	2.4	2.3	2.1	2.0	
59.0	56.7	2.9	2.7	2.5	2.4	2.3	2.1	2.0	

# DC INVERTER MULTI VRF INDOOR UNIT TECHNICAL SALES GUIDE

Heating Capacity (kBtu/h)	Outdoor temperature		Indoor temperature°FDB						
			60.8	64.4	68.0	69.8	71.6	75.2	78.8
			TC	TC	TC	TC	TC	TC	TC
	°FDB	°FWB	kW	kW	kW	kW	kW	kW	kW
09	-3.46	-4.00	1.7	1.7	1.7	1.7	1.7	1.7	1.7
	5.54	5.00	2.0	2.0	2.0	2.0	2.0	2.0	1.9
	9.32	8.60	2.1	2.1	2.1	2.1	2.1	2.1	2.0
	13.1	12.2	2.2	2.2	2.2	2.2	2.2	2.2	2.2
	14.9	14.0	2.2	2.2	2.2	2.2	2.2	2.2	2.2
	16.7	15.6	2.4	2.4	2.4	2.4	2.4	2.4	2.3
	19.4	18.3	2.4	2.4	2.4	2.4	2.4	2.4	2.3
	23.0	21.9	2.5	2.5	2.5	2.5	2.5	2.5	2.5
	26.6	25.3	2.6	2.6	2.6	2.6	2.6	2.6	2.5
	32.0	30.7	2.7	2.7	2.7	2.7	2.7	2.6	2.5
	37.4	36.0	3.0	3.0	3.0	3.0	2.9	2.6	2.5
	41.0	39.4	3.0	3.0	3.0	3.0	2.9	2.6	2.5
	44.6	42.8	3.1	3.1	3.1	3.0	2.9	2.6	2.5
	48.2	46.2	3.2	3.2	3.1	3.0	2.9	2.6	2.5
	51.8	49.6	3.3	3.3	3.1	3.0	2.9	2.6	2.5
55.4	53.2	3.5	3.3	3.1	3.0	2.9	2.6	2.5	
59.0	56.7	3.6	3.3	3.1	3.0	2.9	2.6	2.5	
09(Wall Mounted /Floor and Wall Mounted)	-3.46	-4.00	1.8	1.8	1.8	1.8	1.8	1.8	1.8
	5.54	5.00	2.0	2.0	2.0	2.0	2.0	2.0	2.0
	9.32	8.60	2.2	2.2	2.2	2.2	2.2	2.2	2.1
	13.1	12.2	2.3	2.3	2.3	2.3	2.3	2.3	2.3
	14.9	14.0	2.3	2.3	2.3	2.3	2.3	2.3	2.2
	16.7	15.6	2.4	2.4	2.4	2.4	2.4	2.4	2.4
	19.4	18.3	2.4	2.4	2.4	2.4	2.4	2.4	2.4
	23.0	21.9	2.6	2.6	2.6	2.6	2.6	2.6	2.6
	26.6	25.3	2.7	2.7	2.7	2.7	2.7	2.7	2.6
	32.0	30.7	2.8	2.8	2.8	2.8	2.8	2.7	2.6
	37.4	36.0	3.1	3.1	3.1	3.1	3.0	2.7	2.6
	41.0	39.4	3.1	3.1	3.1	3.1	3.0	2.7	2.6
	44.6	42.8	3.2	3.2	3.2	3.1	3.0	2.7	2.6
	48.2	46.2	3.3	3.3	3.2	3.1	3.0	2.7	2.6
	51.8	49.6	3.5	3.5	3.2	3.1	3.0	2.7	2.6
55.4	53.2	3.6	3.5	3.2	3.1	3.0	2.7	2.6	
59.0	56.7	3.7	3.5	3.2	3.1	3.0	2.7	2.6	

Heating Capacity (kBtu/h)	Outdoor temperature		Indoor temperature°FDB						
			60.8	64.4	68.0	69.8	71.6	75.2	78.8
			TC	TC	TC	TC	TC	TC	TC
	°FDB	°FWB	kW	kW	kW	kW	kW	kW	kW
12	-3.46	-4.00	2.2	2.2	2.2	2.2	2.2	2.2	2.2
	5.54	5.00	2.6	2.6	2.6	2.6	2.6	2.6	2.5
	9.32	8.60	2.7	2.7	2.7	2.7	2.7	2.7	2.6
	13.1	12.2	2.9	2.9	2.9	2.9	2.9	2.9	2.8
	14.9	14.0	2.9	2.9	2.9	2.9	2.9	2.9	2.8
	16.7	15.6	3.0	3.0	3.0	3.0	3.0	3.0	2.9
	19.4	18.3	3.0	3.0	3.0	3.0	3.0	3.0	2.9
	23.0	21.9	3.2	3.2	3.2	3.2	3.2	3.2	3.2
	26.6	25.3	3.4	3.4	3.4	3.4	3.4	3.4	3.2
	32.0	30.7	3.5	3.5	3.5	3.5	3.5	3.4	3.2
	37.4	36.0	3.8	3.8	3.8	3.8	3.7	3.4	3.2
	41.0	39.4	3.8	3.8	3.8	3.8	3.7	3.4	3.2
	44.6	42.8	4.0	4.0	4.0	3.8	3.7	3.4	3.2
	48.2	46.2	4.2	4.2	4.0	3.8	3.7	3.4	3.2
	51.8	49.6	4.3	4.3	4.0	3.8	3.7	3.4	3.2
55.4	53.2	4.5	4.3	4.0	3.8	3.7	3.4	3.2	
59.0	56.7	4.6	4.3	4.0	3.8	3.7	3.4	3.2	
15	-3.46	-4.00	2.8	2.8	2.8	2.8	2.8	2.8	2.8
	5.54	5.00	3.2	3.2	3.2	3.2	3.2	3.2	3.1
	9.32	8.60	3.4	3.4	3.4	3.4	3.4	3.4	3.3
	13.1	12.2	3.6	3.6	3.6	3.6	3.6	3.6	3.5
	14.9	14.0	3.6	3.6	3.6	3.6	3.6	3.6	3.5
	16.7	15.6	3.8	3.8	3.8	3.8	3.8	3.8	3.7
	19.4	18.3	3.8	3.8	3.8	3.8	3.8	3.8	3.7
	23.0	21.9	4.0	4.0	4.0	4.0	4.0	4.0	4.0
	26.6	25.3	4.2	4.2	4.2	4.2	4.2	4.2	4.0
	32.0	30.7	4.4	4.4	4.4	4.4	4.4	4.2	4.0
	37.4	36.0	4.8	4.8	4.8	4.8	4.6	4.2	4.0
	41.0	39.4	4.8	4.8	4.8	4.8	4.6	4.2	4.0
	44.6	42.8	5.0	5.0	5.0	4.8	4.6	4.2	4.0
	48.2	46.2	5.2	5.2	5.0	4.8	4.6	4.2	4.0
	51.8	49.6	5.4	5.4	5.0	4.8	4.6	4.2	4.0
55.4	53.2	5.6	5.4	5.0	4.8	4.6	4.2	4.0	
59.0	56.7	5.8	5.4	5.0	4.8	4.6	4.2	4.0	



# DC INVERTER MULTI VRF INDOOR UNIT TECHNICAL SALES GUIDE

Heating Capacity (kBtu/h)	Outdoor temperature		Indoor temperature°FDB						
			60.8	64.4	68.0	69.8	71.6	75.2	78.8
			TC	TC	TC	TC	TC	TC	TC
	°FDB	°FWB	kW	kW	kW	kW	kW	kW	kW
18(Wall Mounted /Floor and Wall Mounted)	-3.46	-4.00	3.2	3.2	3.2	3.2	3.2	3.2	3.2
	5.54	5.00	3.7	3.7	3.7	3.7	3.7	3.7	3.6
	9.32	8.60	3.9	3.9	3.9	3.9	3.9	3.9	3.8
	13.1	12.2	4.2	4.2	4.2	4.2	4.2	4.2	4.1
	14.9	14.0	4.2	4.2	4.2	4.2	4.2	4.2	4.1
	16.7	15.6	4.4	4.4	4.4	4.4	4.4	4.4	4.3
	19.4	18.3	4.4	4.4	4.4	4.4	4.4	4.4	4.3
	23.0	21.9	4.6	4.6	4.6	4.6	4.6	4.6	4.6
	26.6	25.3	4.9	4.9	4.9	4.9	4.9	4.9	4.6
	32.0	30.7	5.1	5.1	5.1	5.1	5.1	4.9	4.6
	37.4	36.0	5.6	5.6	5.6	5.6	5.3	4.9	4.6
	41.0	39.4	5.6	5.6	5.6	5.6	5.3	4.9	4.6
	44.6	42.8	5.8	5.8	5.8	5.6	5.3	4.9	4.6
	48.2	46.2	6.0	6.0	5.8	5.6	5.3	4.9	4.6
	51.8	49.6	6.3	6.3	5.8	5.6	5.3	4.9	4.6
55.4	53.2	6.5	6.3	5.8	5.6	5.3	4.9	4.6	
59.0	56.7	6.7	6.3	5.8	5.6	5.3	4.9	4.6	
18	13.1	-4.00	6.3	3.3	3.3	3.3	3.3	3.3	3.3
	14.9	5.00	6.5	3.8	3.8	3.8	3.8	3.8	3.7
	16.7	8.60	6.7	4.0	4.0	4.0	4.0	4.0	3.9
	19.4	12.2	3.3	4.2	4.2	4.2	4.2	4.2	4.2
	23.0	14.0	3.8	4.2	4.2	4.2	4.2	4.2	4.1
	26.6	15.6	4.0	4.5	4.5	4.5	4.5	4.5	4.3
	32.0	18.3	4.2	4.5	4.5	4.5	4.5	4.5	4.3
	37.4	21.9	4.2	4.7	4.7	4.7	4.7	4.7	4.7
	41.0	25.3	4.5	5.0	5.0	5.0	5.0	5.0	4.7
	44.6	30.7	4.5	5.2	5.2	5.2	5.2	5.0	4.7
	48.2	36.0	4.7	5.7	5.7	5.7	5.4	5.0	4.7
	51.8	39.4	5.0	5.7	5.7	5.7	5.4	5.0	4.7
	55.4	42.8	5.2	5.9	5.9	5.7	5.4	5.0	4.7
	59.0	46.2	5.7	6.1	5.9	5.7	5.4	5.0	4.7
	-3.46	49.6	5.7	6.4	5.9	5.7	5.4	5.0	4.7
5.54	53.2	5.9	6.4	5.9	5.7	5.4	5.0	4.7	
9.32	56.7	6.1	6.4	5.9	5.7	5.4	5.0	4.7	

Heating Capacity (kBtu/h)	Outdoor temperature		Indoor temperature°FDB						
			60.8	64.4	68.0	69.8	71.6	75.2	78.8
			TC	TC	TC	TC	TC	TC	TC
	°FDB	°FWB	kW	kW	kW	kW	kW	kW	kW
22	-3.46	-4.00	4.0	4.0	4.0	4.0	4.0	4.0	3.9
	5.54	5.00	4.5	4.5	4.5	4.5	4.5	4.5	4.4
	9.32	8.60	4.8	4.8	4.8	4.8	4.8	4.8	4.7
	13.1	12.2	5.1	5.1	5.1	5.1	5.1	5.1	5.0
	14.9	14.0	5.1	5.1	5.1	5.1	5.1	5.1	5.0
	16.7	15.6	5.4	5.4	5.4	5.4	5.4	5.4	5.2
	19.4	18.3	5.4	5.4	5.4	5.4	5.4	5.4	5.2
	23.0	21.9	5.7	5.7	5.7	5.7	5.7	5.7	5.7
	26.6	25.3	6.0	6.0	6.0	6.0	6.0	6.0	5.7
	32.0	30.7	6.2	6.2	6.2	6.2	6.2	6.0	5.7
	37.4	36.0	6.8	6.8	6.8	6.8	6.5	6.0	5.7
	41.0	39.4	6.8	6.8	6.8	6.8	6.5	6.0	5.7
	44.6	42.8	7.1	7.1	7.1	6.8	6.5	6.0	5.7
	48.2	46.2	7.4	7.4	7.1	6.8	6.5	6.0	5.7
	51.8	49.6	7.7	7.7	7.1	6.8	6.5	6.0	5.7
55.4	53.2	8.0	7.7	7.1	6.8	6.5	6.0	5.7	
59.0	56.7	8.2	7.7	7.1	6.8	6.5	6.0	5.7	
24(Wall Mounted)	-3.46	-4.00	4.2	4.2	4.2	4.2	4.2	4.2	4.1
	5.54	5.00	4.8	4.8	4.8	4.8	4.8	4.8	4.7
	9.32	8.60	5.1	5.1	5.1	5.1	5.1	5.1	4.9
	13.1	12.2	5.4	5.4	5.4	5.4	5.4	5.4	5.3
	14.9	14.0	5.4	5.4	5.4	5.4	5.4	5.4	5.3
	16.7	15.6	5.7	5.7	5.7	5.7	5.7	5.7	5.5
	19.4	18.3	5.7	5.7	5.7	5.7	5.7	5.7	5.5
	23.0	21.9	6.0	6.0	6.0	6.0	6.0	6.0	6.0
	26.6	25.3	6.3	6.3	6.3	6.3	6.3	6.3	6.0
	32.0	30.7	6.6	6.6	6.6	6.6	6.6	6.3	6.0
	37.4	36.0	7.2	7.2	7.2	7.2	6.9	6.3	6.0
	41.0	39.4	7.2	7.2	7.2	7.2	6.9	6.3	6.0
	44.6	42.8	7.5	7.5	7.5	7.2	6.9	6.3	6.0
	48.2	46.2	7.8	7.8	7.5	7.2	6.9	6.3	6.0
	51.8	49.6	8.1	8.1	7.5	7.2	6.9	6.3	6.0
55.4	53.2	8.4	8.1	7.5	7.2	6.9	6.3	6.0	
59.0	56.7	8.7	8.1	7.5	7.2	6.9	6.3	6.0	

# DC INVERTER MULTI VRF INDOOR UNIT TECHNICAL SALES GUIDE

Heating Capacity (kBtu/h)	Outdoor temperature		Indoor temperature°FDB						
			60.8	64.4	68.0	69.8	71.6	75.2	78.8
			TC	TC	TC	TC	TC	TC	TC
	°FDB	°FWB	kW	kW	kW	kW	kW	kW	kW
24	-3.46	-4.00	4.4	4.4	4.4	4.4	4.4	4.4	4.4
	5.54	5.00	5.1	5.1	5.1	5.1	5.1	5.1	4.9
	9.32	8.60	5.4	5.4	5.4	5.4	5.4	5.4	5.2
	13.1	12.2	5.7	5.7	5.7	5.7	5.7	5.7	5.6
	14.9	14.0	5.7	5.7	5.7	5.7	5.7	5.7	5.5
	16.7	15.6	6.0	6.0	6.0	6.0	6.0	6.0	5.8
	19.4	18.3	6.0	6.0	6.0	6.0	6.0	6.0	5.8
	23.0	21.9	6.3	6.3	6.3	6.3	6.3	6.3	6.3
	26.6	25.3	6.6	6.6	6.6	6.6	6.6	6.6	6.3
	32.0	30.7	7.0	7.0	7.0	7.0	7.0	6.6	6.3
	37.4	36.0	7.6	7.6	7.6	7.6	7.3	6.6	6.3
	41.0	39.4	7.6	7.6	7.6	7.6	7.3	6.6	6.3
	44.6	42.8	7.9	7.9	7.9	7.6	7.3	6.6	6.3
	48.2	46.2	8.2	8.2	7.9	7.6	7.3	6.6	6.3
	51.8	49.6	8.5	8.5	7.9	7.6	7.3	6.6	6.3
55.4	53.2	8.9	8.5	7.9	7.6	7.3	6.6	6.3	
59.0	56.7	9.1	8.5	7.9	7.6	7.3	6.6	6.3	
30	-3.46	-4.00	5.6	5.6	5.6	5.6	5.6	5.6	5.5
	5.54	5.00	6.4	6.4	6.4	6.4	6.4	6.4	6.2
	9.32	8.60	6.8	6.8	6.8	6.8	6.8	6.8	6.6
	13.1	12.2	7.2	7.2	7.2	7.2	7.2	7.2	7.0
	14.9	14.0	7.2	7.2	7.2	7.2	7.2	7.2	7.0
	16.7	15.6	7.6	7.6	7.6	7.6	7.6	7.6	7.4
	19.4	18.3	7.6	7.6	7.6	7.6	7.6	7.6	7.4
	23.0	21.9	8.0	8.0	8.0	8.0	8.0	8.0	8.0
	26.6	25.3	8.4	8.4	8.4	8.4	8.4	8.4	8.0
	32.0	30.7	8.8	8.8	8.8	8.8	8.8	8.4	8.0
	37.4	36.0	9.6	9.6	9.6	9.6	9.2	8.4	8.0
	41.0	39.4	9.6	9.6	9.6	9.6	9.2	8.4	8.0
	44.6	42.8	10.0	10.0	10.0	9.6	9.2	8.4	8.0
	48.2	46.2	10.4	10.4	10.0	9.6	9.2	8.4	8.0
	51.8	49.6	10.8	10.8	10.0	9.6	9.2	8.4	8.0
55.4	53.2	11.2	10.8	10.0	9.6	9.2	8.4	8.0	
59.0	56.7	11.6	10.8	10.0	9.6	9.2	8.4	8.0	

Heating Capacity (kBtu/h)	Outdoor temperature		Indoor temperature°FDB						
			60.8	64.4	68.0	69.8	71.6	75.2	78.8
			TC	TC	TC	TC	TC	TC	TC
	°FDB	°FWB	kW	kW	kW	kW	kW	kW	kW
36	-3.46	-4.00	6.6	6.6	6.6	6.6	6.6	6.6	6.5
	5.54	5.00	7.5	7.5	7.5	7.5	7.5	7.5	7.3
	9.32	8.60	8.0	8.0	8.0	8.0	8.0	8.0	7.7
	13.1	12.2	8.4	8.4	8.4	8.4	8.4	8.4	8.2
	14.9	14.0	8.4	8.4	8.4	8.4	8.4	8.4	8.2
	16.7	15.6	8.9	8.9	8.9	8.9	8.9	8.9	8.6
	19.4	18.3	8.9	8.9	8.9	8.9	8.9	8.9	8.6
	23.0	21.9	9.4	9.4	9.4	9.4	9.4	9.4	9.4
	26.6	25.3	9.8	9.8	9.8	9.8	9.8	9.8	9.4
	32.0	30.7	10.3	10.3	10.3	10.3	10.3	9.8	9.4
	37.4	36.0	11.2	11.2	11.2	11.2	10.8	9.8	9.4
	41.0	39.4	11.2	11.2	11.2	11.2	10.8	9.8	9.4
	44.6	42.8	11.7	11.7	11.7	11.2	10.8	9.8	9.4
	48.2	46.2	12.2	12.2	11.7	11.2	10.8	9.8	9.4
	51.8	49.6	12.6	12.6	11.7	11.2	10.8	9.8	9.4
55.4	53.2	13.1	12.6	11.7	11.2	10.8	9.8	9.4	
59.0	56.7	13.5	12.6	11.7	11.2	10.8	9.8	9.4	
42	-3.46	-4.00	7.7	7.7	7.7	7.7	7.7	7.7	7.6
	5.54	5.00	8.8	8.8	8.8	8.8	8.8	8.8	8.6
	9.32	8.60	9.4	9.4	9.4	9.4	9.4	9.4	9.1
	13.1	12.2	9.9	9.9	9.9	9.9	9.9	9.9	9.7
	14.9	14.0	9.9	9.9	9.9	9.9	9.9	9.9	9.7
	16.7	15.6	10.5	10.5	10.5	10.5	10.5	10.5	10.2
	19.4	18.3	10.5	10.5	10.5	10.5	10.5	10.5	10.2
	23.0	21.9	11.0	11.0	11.0	11.0	11.0	11.0	11.0
	26.6	25.3	11.6	11.6	11.6	11.6	11.6	11.6	11.0
	32.0	30.7	12.1	12.1	12.1	12.1	12.1	11.6	11.0
	37.4	36.0	13.2	13.2	13.2	13.2	12.7	11.6	11.0
	41.0	39.4	13.2	13.2	13.2	13.2	12.7	11.6	11.0
	44.6	42.8	13.8	13.8	13.8	13.2	12.7	11.6	11.0
	48.2	46.2	14.4	14.4	13.8	13.2	12.7	11.6	11.0
	51.8	49.6	14.9	14.9	13.8	13.2	12.7	11.6	11.0
55.4	53.2	15.5	14.9	13.8	13.2	12.7	11.6	11.0	
59.0	56.7	16.0	14.9	13.8	13.2	12.7	11.6	11.0	

# DC INVERTER MULTI VRF INDOOR UNIT TECHNICAL SALES GUIDE

Heating Capacity (kBtu/h)	Outdoor temperature		Indoor temperature°FDB						
			60.8	64.4	68.0	69.8	71.6	75.2	78.8
			TC	TC	TC	TC	TC	TC	TC
	°FDB	°FWB	kW	kW	kW	kW	kW	kW	kW
48	-3.46	-4.00	8.8	8.8	8.8	8.8	8.8	8.8	8.7
	5.54	5.00	10.1	10.1	10.1	10.1	10.1	10.1	9.9
	9.32	8.60	10.7	10.7	10.7	10.7	10.7	10.7	10.4
	13.1	12.2	11.4	11.4	11.4	11.4	11.4	11.4	11.1
	14.9	14.0	11.4	11.4	11.4	11.4	11.4	11.4	11.1
	16.7	15.6	12.0	12.0	12.0	12.0	12.0	12.0	11.6
	19.4	18.3	12.0	12.0	12.0	12.0	12.0	12.0	11.6
	23.0	21.9	12.6	12.6	12.6	12.6	12.6	12.6	12.6
	26.6	25.3	13.3	13.3	13.3	13.3	13.3	13.3	12.6
	32.0	30.7	13.9	13.9	13.9	13.9	13.9	13.3	12.6
	37.4	36.0	15.2	15.2	15.2	15.2	14.6	13.3	12.6
	41.0	39.4	15.2	15.2	15.2	15.2	14.6	13.3	12.6
	44.6	42.8	15.8	15.8	15.8	15.2	14.6	13.3	12.6
	48.2	46.2	16.4	16.4	15.8	15.2	14.6	13.3	12.6
	51.8	49.6	17.1	17.1	15.8	15.2	14.6	13.3	12.6
55.4	53.2	17.7	17.1	15.8	15.2	14.6	13.3	12.6	
59.0	56.7	18.3	17.1	15.8	15.2	14.6	13.3	12.6	
54	-19.7	-20	9.8	9.8	9.8	9.8	9.8	9.8	9.7
	-14.7	-15	11.2	11.2	11.2	11.2	11.2	11.2	10.9
	-12.6	-13	11.9	11.9	11.9	11.9	11.9	11.9	11.5
	-10.5	-11	12.6	12.6	12.6	12.6	12.6	12.6	12.3
	-9.5	-10	12.6	12.6	12.6	12.6	12.6	12.6	12.3
	-8.5	-9.1	13.3	13.3	13.3	13.3	13.3	13.3	12.9
	-7	-7.6	13.3	13.3	13.3	13.3	13.3	13.3	12.9
	-5	-5.6	14	14	14	14	14	14	14
	-3	-3.7	14.7	14.7	14.7	14.7	14.7	14.7	14
	0	-0.7	15.4	15.4	15.4	15.4	15.4	14.7	14
	3	2.2	16.8	16.8	16.8	16.8	16.1	14.7	14
	5	4.1	16.8	16.8	16.8	16.8	16.1	14.7	14
	7	6	17.5	17.5	17.5	16.8	16.1	14.7	14
	9	7.9	18.2	18.2	17.5	16.8	16.1	14.7	14
	11	9.8	18.9	18.9	17.5	16.8	16.1	14.7	14
13	11.8	19.7	18.9	17.5	16.8	16.1	14.7	14	
15	13.7	20.2	18.9	17.5	16.8	16.1	14.7	14	

Heating Capacity (kBtu/h)	Outdoor temperature		Indoor temperature°FDB						
			60.8	64.4	68.0	69.8	71.6	75.2	78.8
			TC	TC	TC	TC	TC	TC	TC
	°FDB	°FWB	kW	kW	kW	kW	kW	kW	kW
72	-3.46	-4.00	12.7	12.7	12.7	12.7	12.7	12.7	12.5
	5.54	5.00	14.5	14.5	14.5	14.5	14.5	14.5	14.1
	9.32	8.60	15.4	15.4	15.4	15.4	15.4	15.4	14.8
	13.1	12.2	16.3	16.3	16.3	16.3	16.3	16.3	15.9
	14.9	14.0	16.3	16.3	16.3	16.3	16.3	16.3	15.9
	16.7	15.6	17.2	17.2	17.2	17.2	17.2	17.2	16.6
	19.4	18.3	17.2	17.2	17.2	17.2	17.2	17.2	16.6
	23.0	21.9	18.1	18.1	18.1	18.1	18.1	18.1	18.1
	26.6	25.3	19.0	19.0	19.0	19.0	19.0	19.0	18.1
	32.0	30.7	19.9	19.9	19.9	19.9	19.9	19.0	18.1
	37.4	36.0	21.7	21.7	21.7	21.7	20.8	19.0	18.1
	41.0	39.4	21.7	21.7	21.7	21.7	20.8	19.0	18.1
	44.6	42.8	22.6	22.6	22.6	21.7	20.8	19.0	18.1
	48.2	46.2	23.5	23.5	22.6	21.7	20.8	19.0	18.1
	51.8	49.6	24.4	24.4	22.6	21.7	20.8	19.0	18.1
55.4	53.2	25.4	24.4	22.6	21.7	20.8	19.0	18.1	
59.0	56.7	26.1	24.4	22.6	21.7	20.8	19.0	18.1	
96	-3.46	-4.00	16.9	16.9	16.9	16.9	16.9	16.9	16.7
	5.54	5.00	19.3	19.3	19.3	19.3	19.3	19.3	18.8
	9.32	8.60	20.5	20.5	20.5	20.5	20.5	20.5	19.8
	13.1	12.2	21.7	21.7	21.7	21.7	21.7	21.7	21.3
	14.9	14.0	21.7	21.7	21.7	21.7	21.7	21.7	21.2
	16.7	15.6	23.0	23.0	23.0	23.0	23.0	23.0	22.2
	19.4	18.3	23.0	23.0	23.0	23.0	23.0	23.0	22.2
	23.0	21.9	24.2	24.2	24.2	24.2	24.2	24.2	24.2
	26.6	25.3	25.4	25.4	25.4	25.4	25.4	25.4	24.2
	32.0	30.7	26.6	26.6	26.6	26.6	26.6	25.4	24.2
	37.4	36.0	29.0	29.0	29.0	29.0	27.8	25.4	24.2
	41.0	39.4	29.0	29.0	29.0	29.0	27.8	25.4	24.2
	44.6	42.8	30.2	30.2	30.2	29.0	27.8	25.4	24.2
	48.2	46.2	31.4	31.4	30.2	29.0	27.8	25.4	24.2
	51.8	49.6	32.6	32.6	30.2	29.0	27.8	25.4	24.2
55.4	53.2	33.9	32.6	30.2	29.0	27.8	25.4	24.2	
59.0	56.7	34.9	32.6	30.2	29.0	27.8	25.4	24.2	

# DC INVERTER MULTI VRF INDOOR UNIT TECHNICAL SALES GUIDE

## Fresh air Processing

Heating Capacity (kBtu/h)	Outdoor temperature		Indoor temperature <sup>°FDB</sup>						
			60.8	64.4	68.0	69.8	71.6	75.2	78.8
			TC	TC	TC	TC	TC	TC	TC
	°FDB	°FWB	kW	kW	kW	kW	kW	kW	kW
72	-3.46	-4.00	9.0	9.0	9.03	9.0	9.0	9.0	8.9
	5.54	5.00	10.3	10.3	10.32	10.3	10.3	10.3	10.1
	9.32	8.60	11.0	11.0	10.96	11.0	11.0	11.0	10.6
	13.1	12.2	11.6	11.6	11.61	11.6	11.6	11.6	11.3
	14.9	14.0	11.6	11.6	11.61	11.6	11.6	11.6	11.3
	16.7	15.6	12.3	12.3	12.25	12.3	12.3	12.3	11.9
	19.4	18.3	12.3	12.3	12.25	12.3	12.3	12.3	11.9
	23.0	21.9	12.9	12.9	12.90	12.9	12.9	12.9	12.9
	26.6	25.3	13.5	13.5	13.54	13.5	13.5	13.6	12.9
	32.0	30.7	14.2	14.2	14.19	14.2	14.2	13.6	12.9
	37.4	36.0	15.5	15.5	15.48	15.5	14.9	13.6	12.9
	41.0	39.4	15.5	15.5	15.48	15.5	14.9	13.6	12.9
	44.6	42.8	16.1	16.1	16.12	15.5	14.9	13.6	12.9
	48.2	46.2	16.8	16.8	16.12	15.5	14.9	13.6	12.9
	51.8	49.6	17.4	17.4	16.12	15.5	14.9	13.6	12.9
	55.4	53.2	18.1	17.4	16.12	15.5	14.9	13.6	12.9
59.0	56.7	18.6	17.4	16.12	15.5	14.9	13.6	12.9	
96	-3.46	-4.00	11.2	11.2	11.16	11.2	11.2	11.2	11.0
	5.54	5.00	12.8	12.8	12.76	12.8	12.8	12.8	12.4
	9.32	8.60	13.6	13.6	13.55	13.6	13.6	13.6	13.1
	13.1	12.2	14.3	14.3	14.35	14.3	14.3	14.3	14.0
	14.9	14.0	14.3	14.3	14.35	14.3	14.3	14.3	14.0
	16.7	15.6	15.1	15.1	15.15	15.1	15.1	15.1	14.7
	19.4	18.3	15.1	15.1	15.15	15.1	15.1	15.1	14.7
	23.0	21.9	15.9	15.9	15.94	15.9	15.9	15.9	15.9
	26.6	25.3	16.7	16.7	16.74	16.7	16.7	16.8	15.9
	32.0	30.7	17.5	17.5	17.54	17.5	17.5	16.8	15.9
	37.4	36.0	19.1	19.1	19.13	19.1	18.4	16.8	15.9
	41.0	39.4	19.1	19.1	19.13	19.1	18.4	16.8	15.9
	44.6	42.8	19.9	19.9	19.93	19.1	18.4	16.8	15.9
	48.2	46.2	20.7	20.7	19.93	19.1	18.4	16.8	15.9
	51.8	49.6	21.5	21.5	19.93	19.1	18.4	16.8	15.9
	55.4	53.2	22.4	21.5	19.93	19.1	18.4	16.8	15.9
59.0	56.7	23.0	21.5	19.9	19.1	18.4	16.8	15.9	

# 5 UNIT NOISE CURVES

## 5.1 Low Static Pressure Duct Type Indoor Unit GMV-ND\*\*PLS/A-T(U)

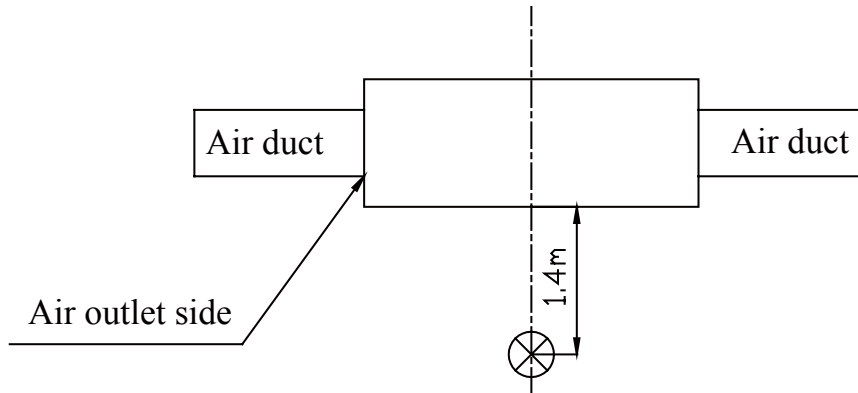

Transducer of sound level meter

**NOTICE!**

- ① The noise level is measured in the semi-anechoic room. It will be slightly higher due to change of the environment during actual operation.
- ② The noise level is measured under the standard test condition.
- ③ The noise level is measured under the condition of rear air return. The noise level will be a little higher if the lower air return mode is adopted.

Model 07/09

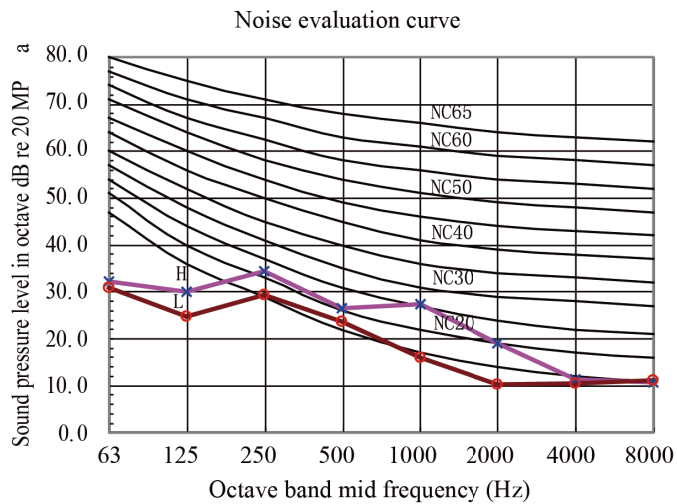



## Model 12

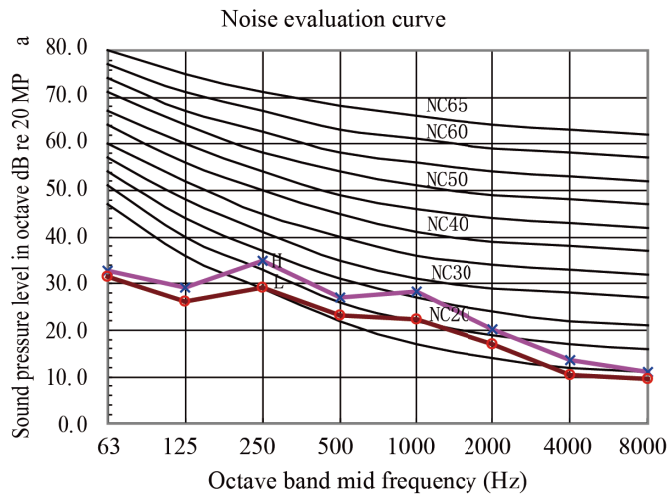

## Model 14

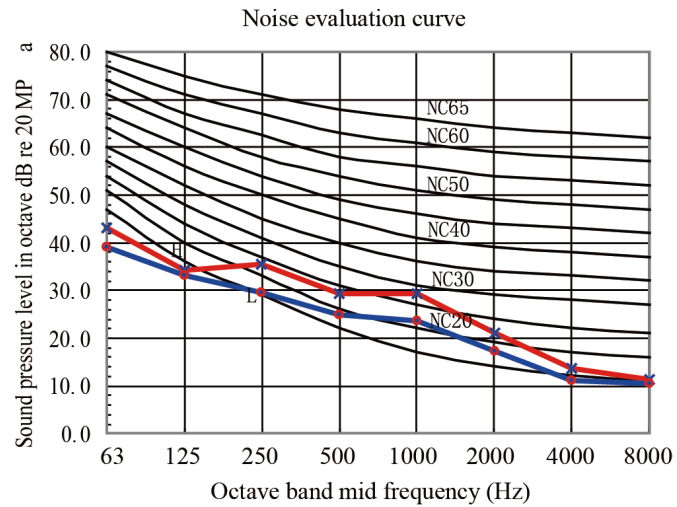

## Model 18/22

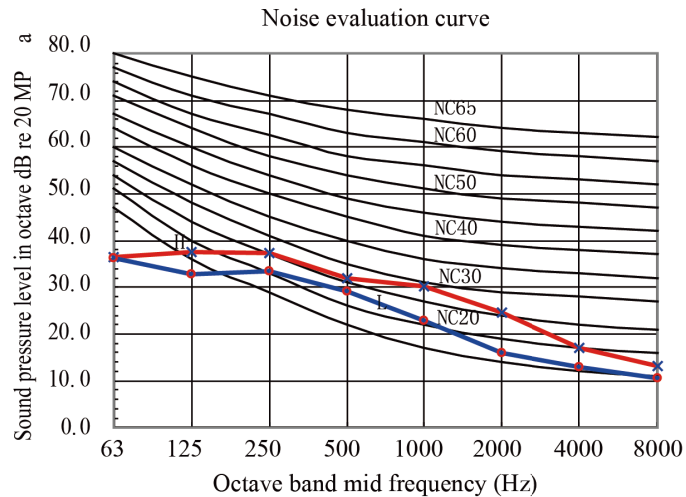

## 5.2 Slim Duct Type Indoor Unit

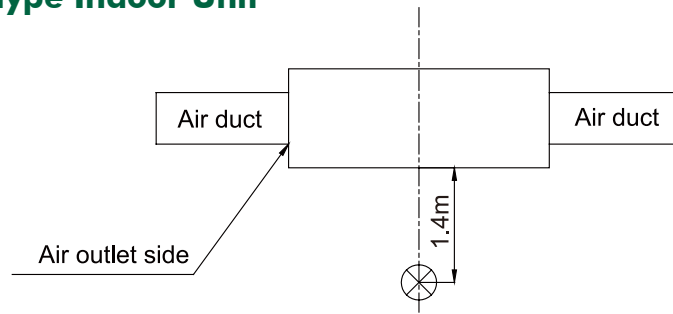

Transducer meter of sound level meter

**NOTICE!**

- ① The noise level is measured in the semi-anechoic room. It will be slightly higher due to change of the environment during actual operation.
- ② The noise level is measured under the standard test condition.
- ③ The noise level is measured under the condition of rear air return. The noise level will be a little higher if the lower air return mode is adopted.

Model 07-09

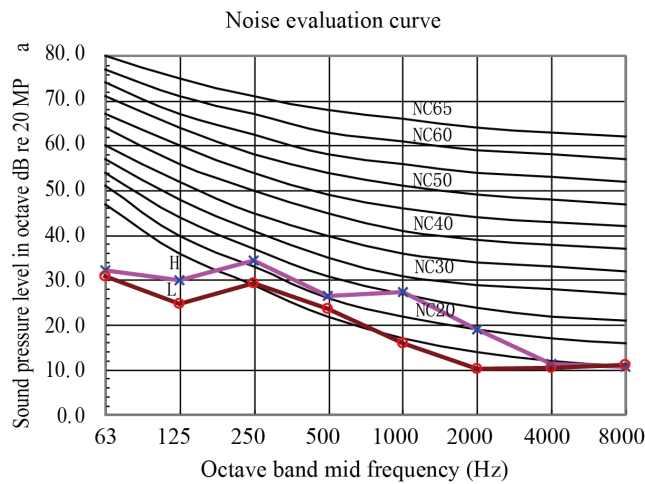

Model 12

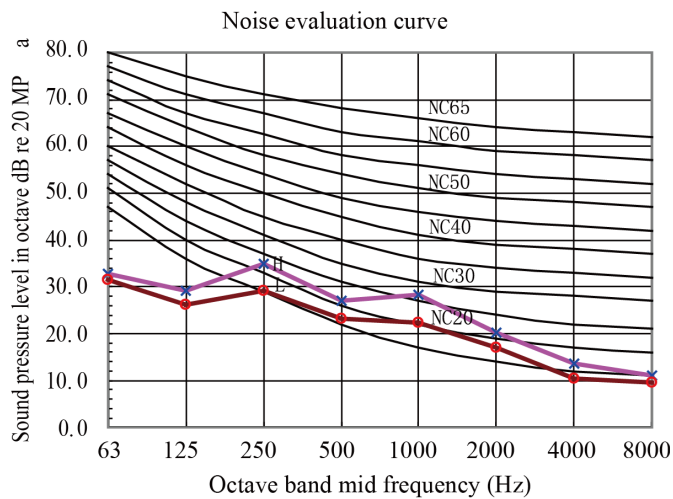

Model 14

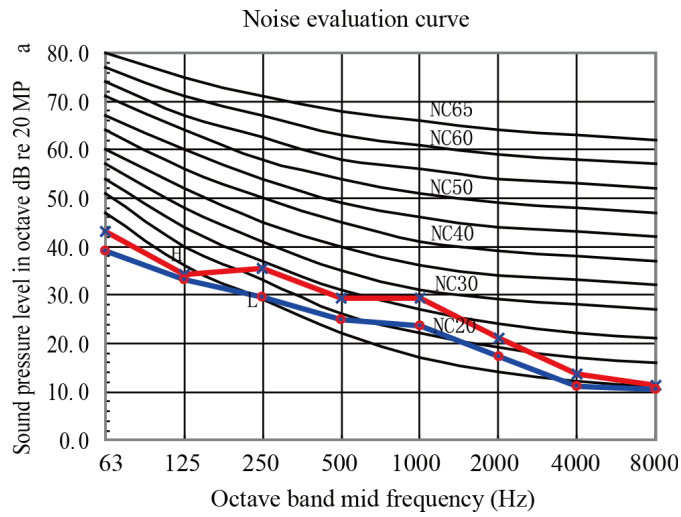

Model 18、24

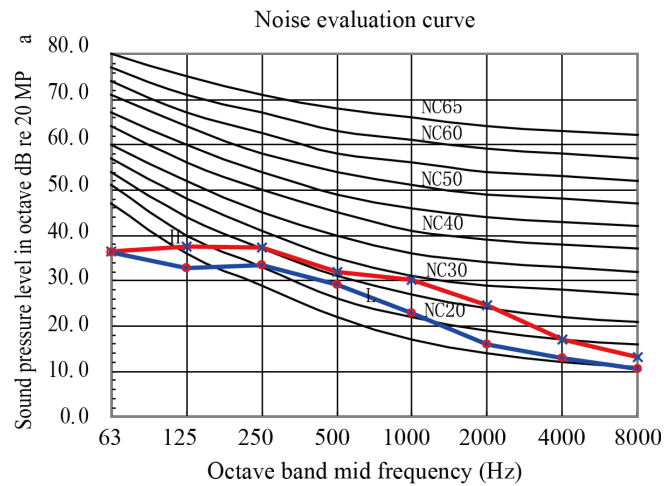

## ➔ 5.3 Four-way Cassette Indoor Unit GMV-ND\*\*T/A-T(U)

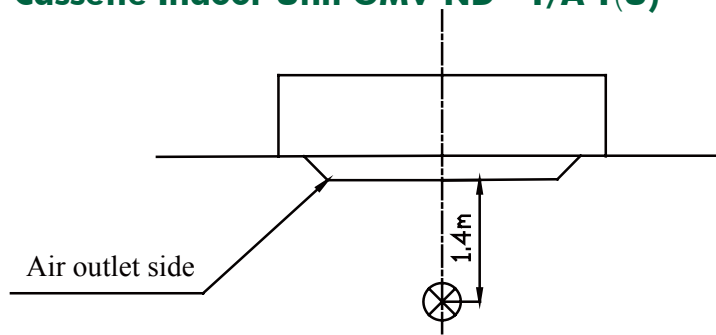

Transient meter of sound level meter

NOTICE!

- ① The noise level is measured in the semi-anechoic room. It will be slightly higher due to change of the environment during actual operation.
- ② The noise level is measured under the standard test condition.

Model 07

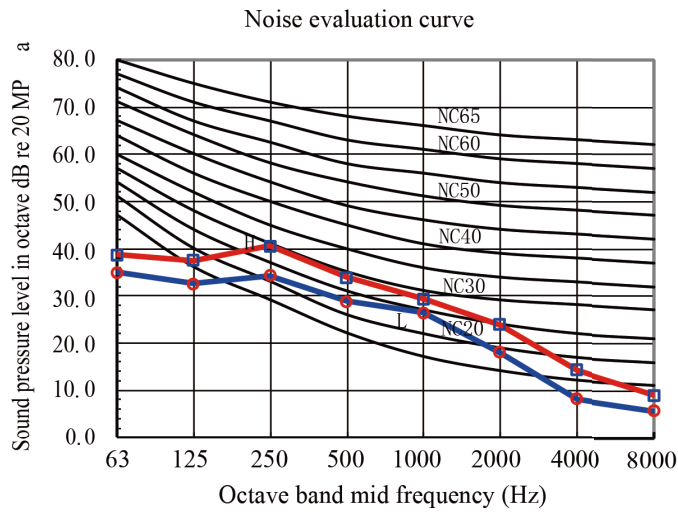

Model 09-18

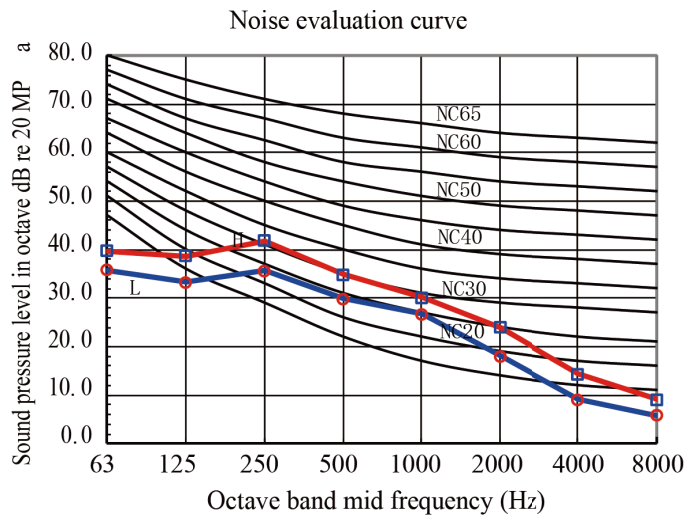

Model 24

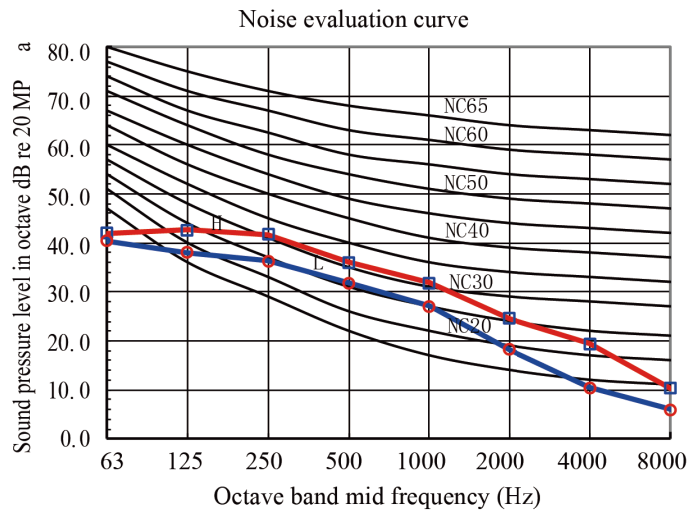

## Model 30

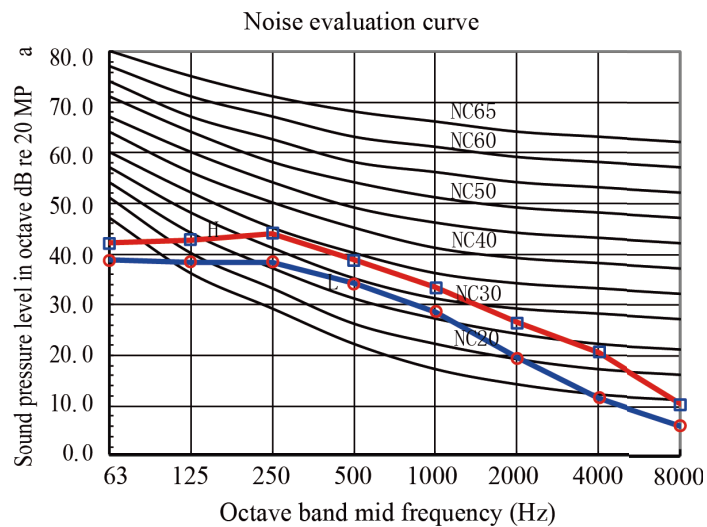

## Model 36

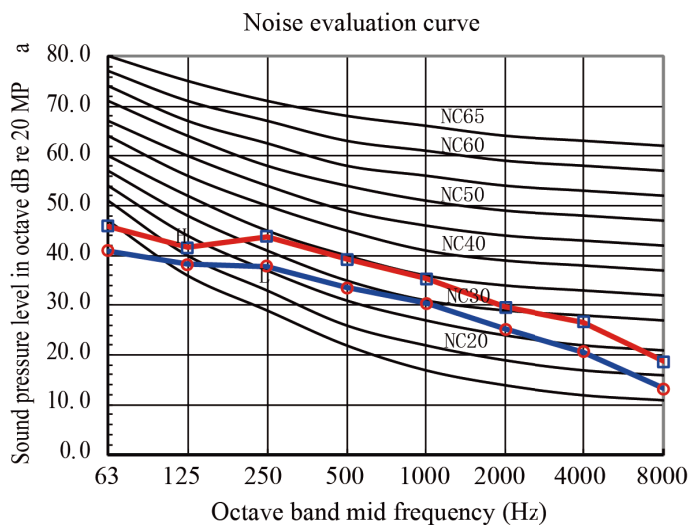

## Model 42/48

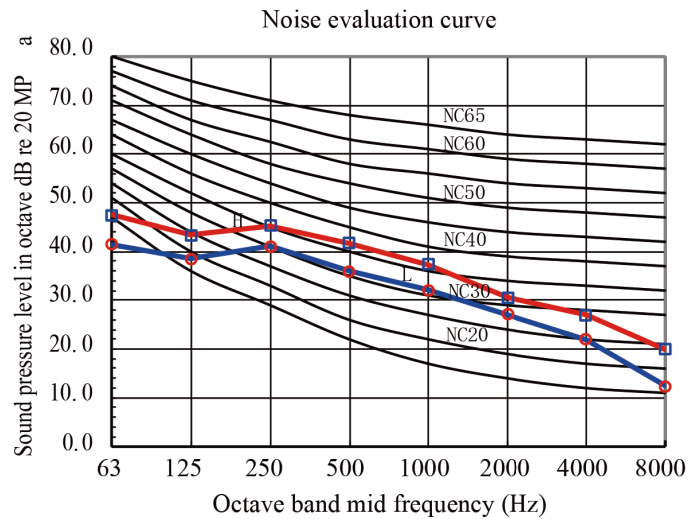

## 5.4 High Static Pressure Duct Type Indoor Unit GMV-ND\*\*PHS/A-T(U),GMV-ND\*\*PH/A-T(U)

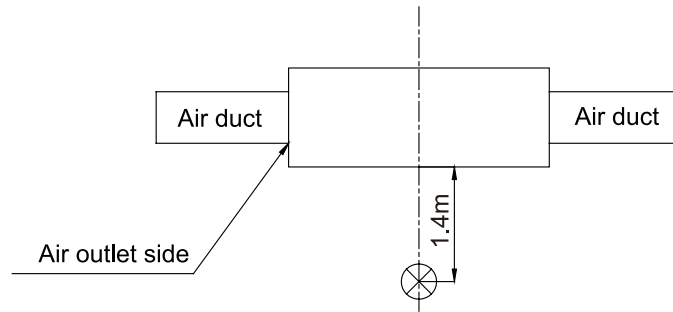

Transducer meter of sound level meter

**NOTICE!**

- ① The noise level is measured in the semi-anechoic room. It will be slightly higher due to change of the environment during actual operation.
- ② The noise level is measured under the standard test condition.
- ③ The noise level is measured under the condition of rear air return.

Model 18

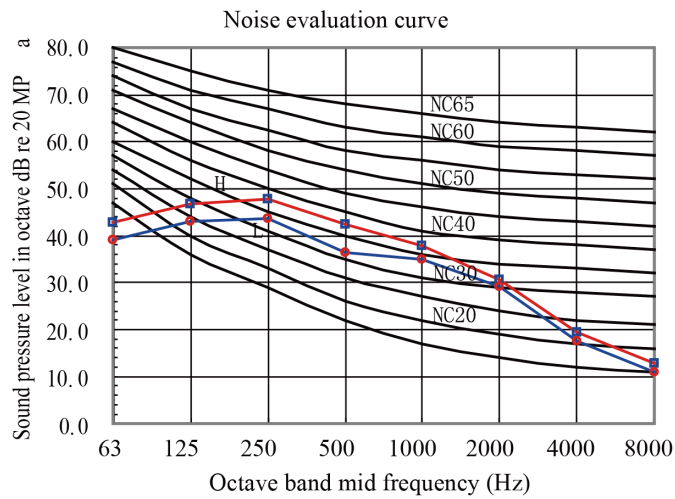

Model 24

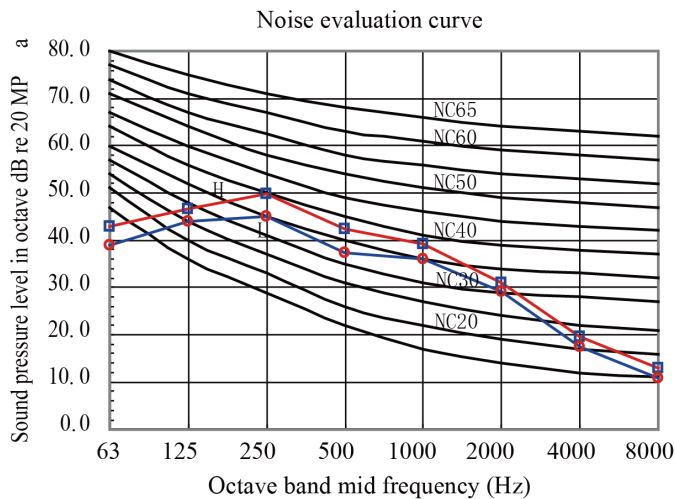

## Model 30/36

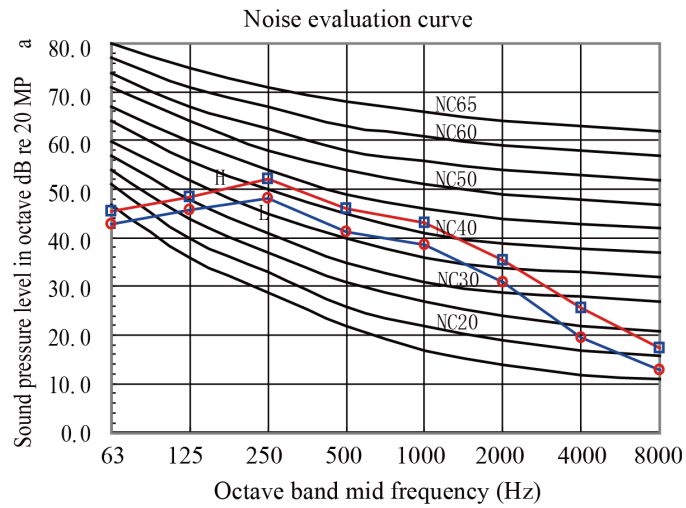

## Model 42/48

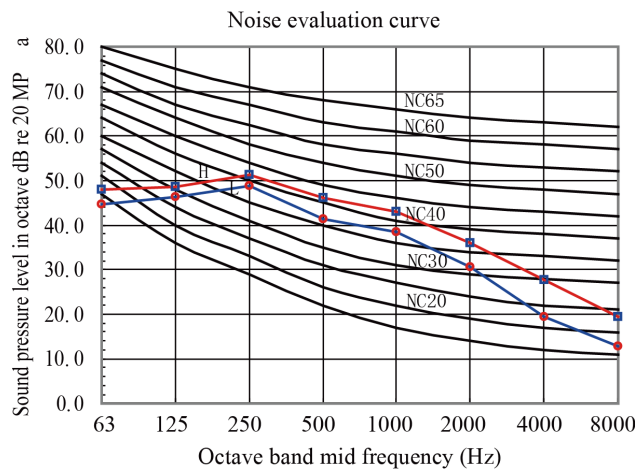

## Model 72

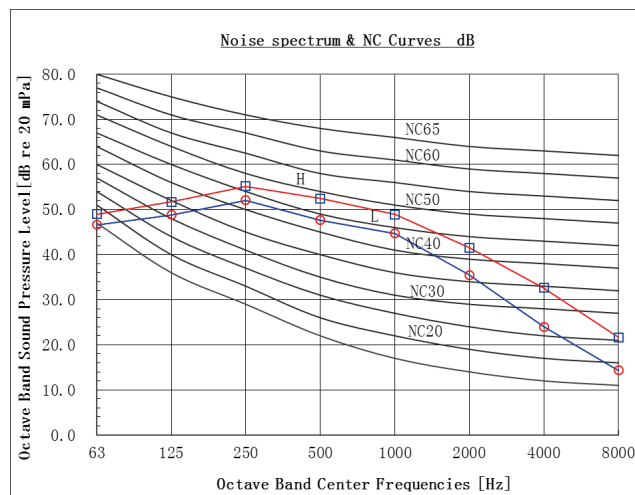

Model 96

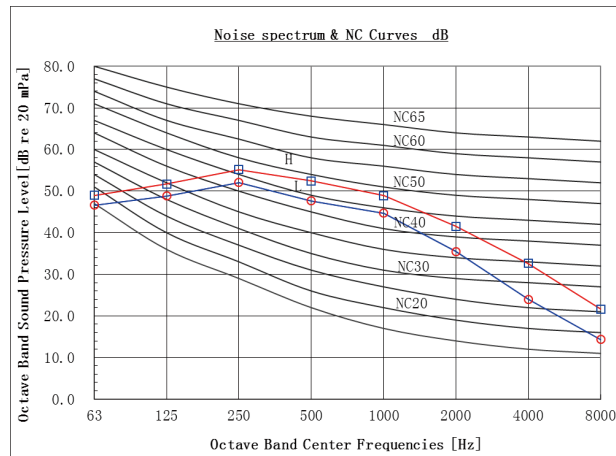

### 5.5 Floor Ceiling Type Indoor Unit GMV-ND\*\*ZD/A-T(U)

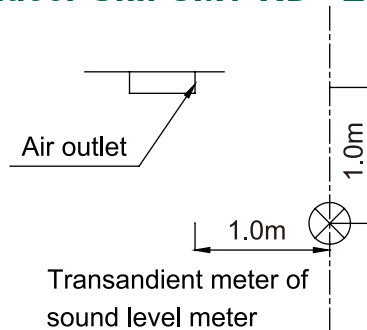

NOTICE!

- ① The noise level is measured in the semi-anechoic room. It will be slightly higher due to change of the environment during actual operation.
- ② The noise level is measured under the standard test condition.
- ③ The noise level is measured under the condition of ceiling installation.

Model 09/12

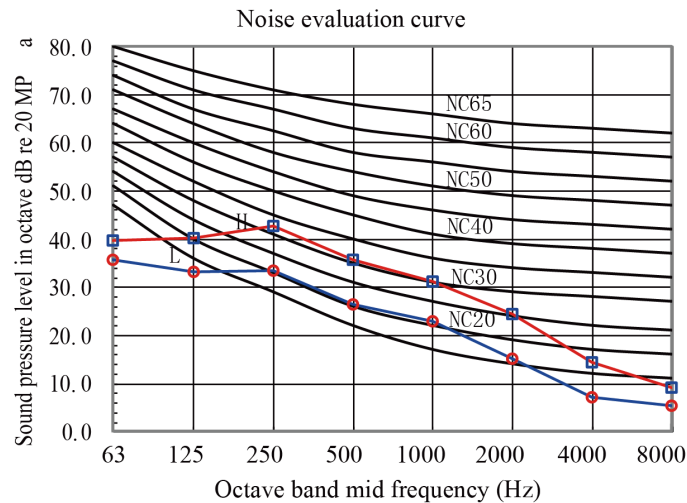



## Model 18

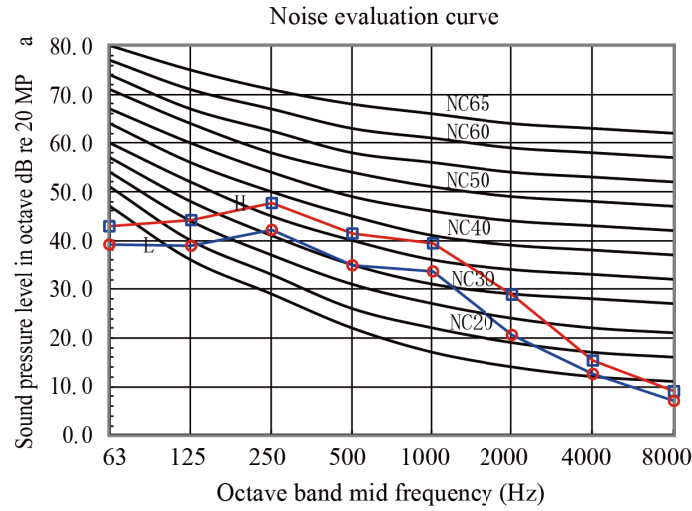

## Model 24

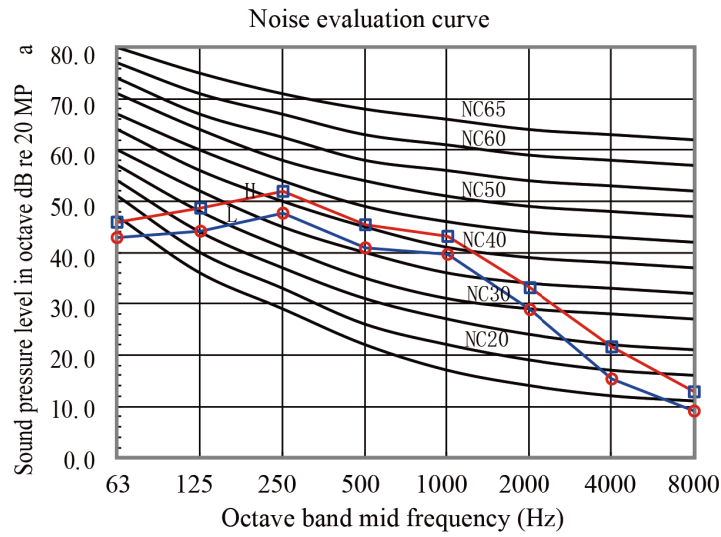

## Model 30

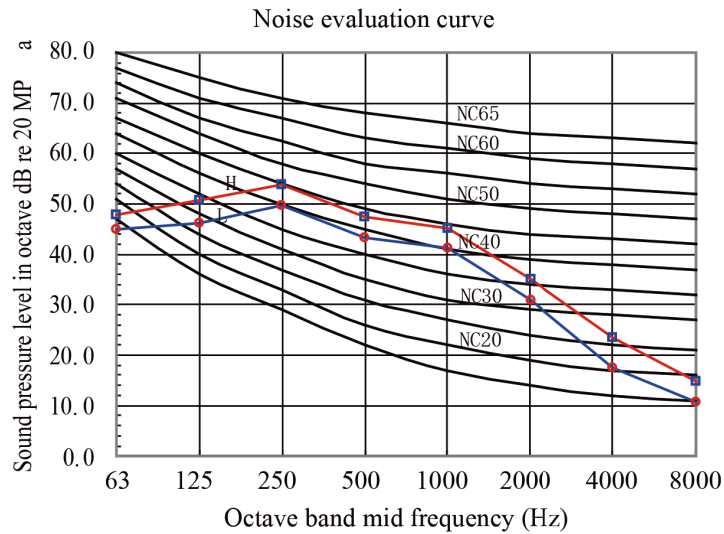

Model 36/42/48

Noise evaluation curve

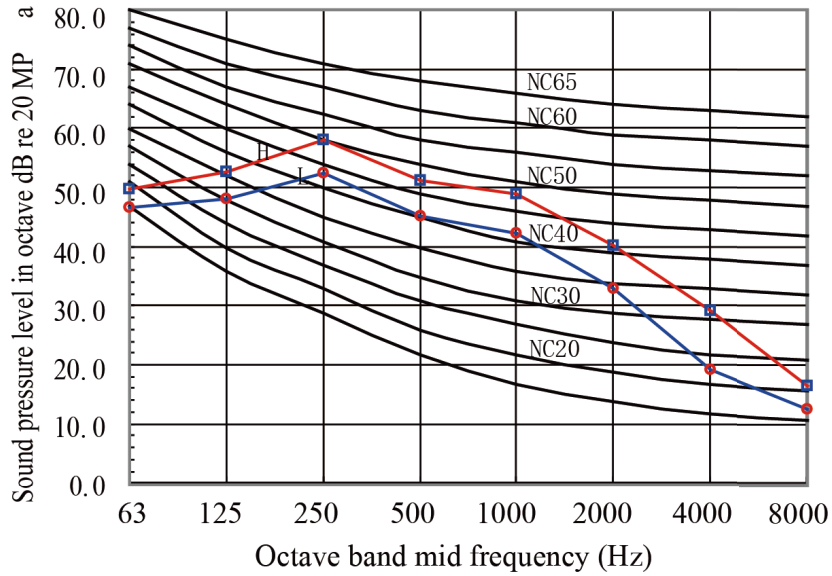

## ➔ 5.6 Wall Mounted Type Indoor Unit GMV-N\*\*G/A3A-D(U)

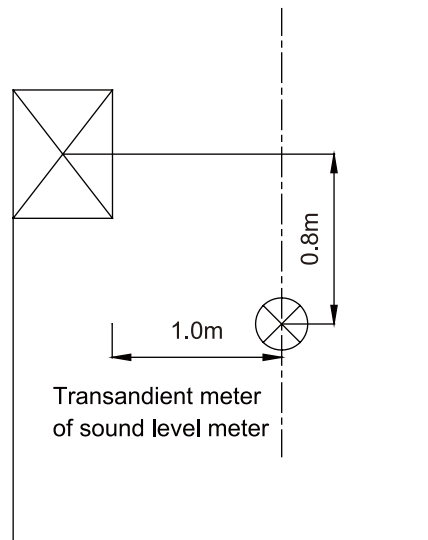

**NOTICE!**

- ① The noise level is measured in the semi-anechoic room. It will be slightly higher due to change of the environment during actual operation.
- ② The noise level is measured under the standard test condition.

## Model 07/09

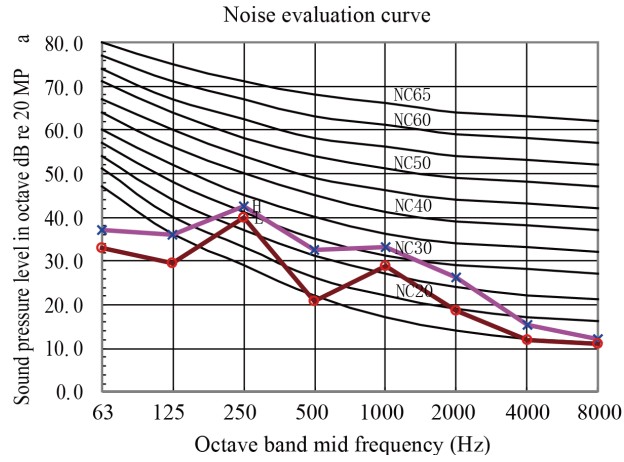

## Model 12/18

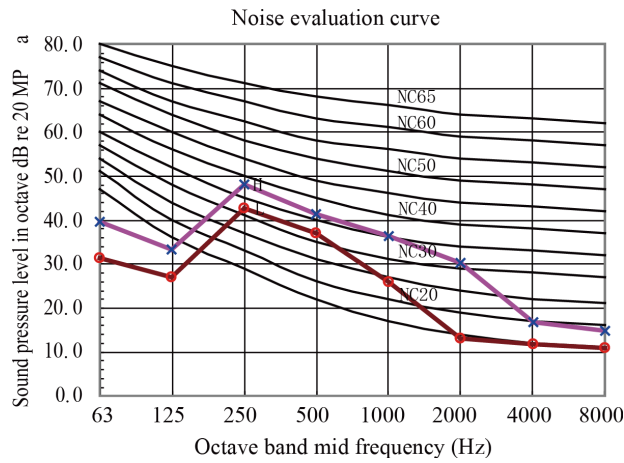

## Model 24

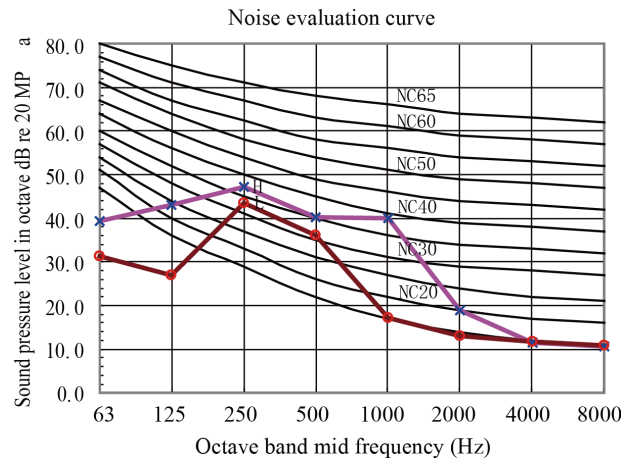

## ➔ 5.7 Fresh Air Processing Unit GMV-NDX\*\*P/A-T(U)

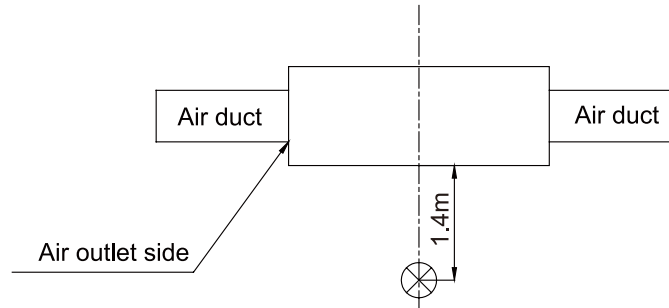

Transducer of sound level meter

**NOTICE!**

- ① The noise level is measured in the semi-anechoic room. It will be slightly higher due to change of the environment during actual operation.
- ② The noise level is measured under the standard test condition.
- ③ The noise level is measured under the condition of rear air return.

Model 72

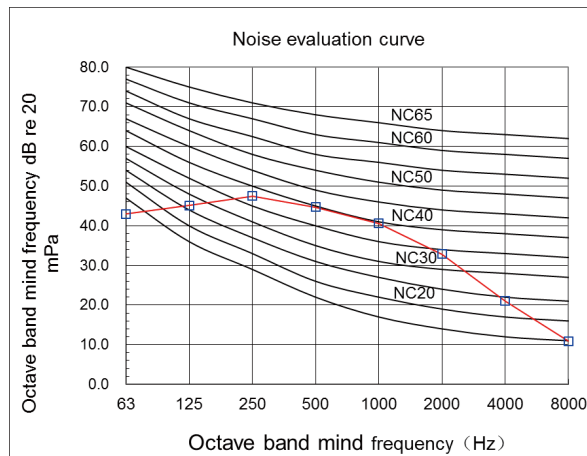

Model 96

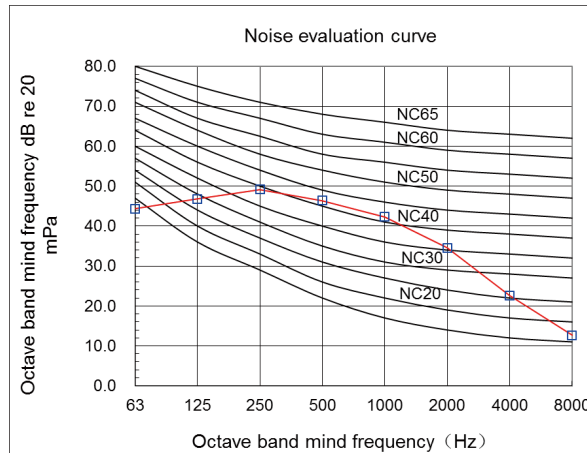

## 5.8 Console Type GMV-ND\*\*C/A-T(U)

Floor type

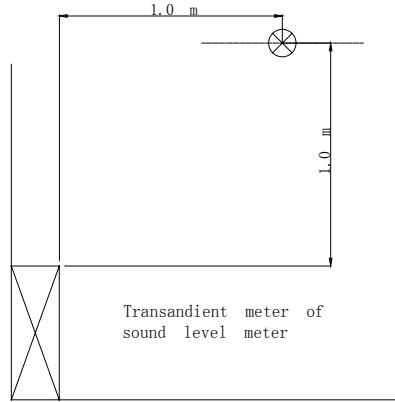

Wall Mounted type

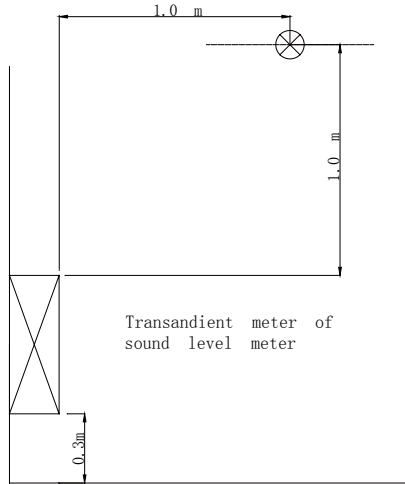

Model 07/09

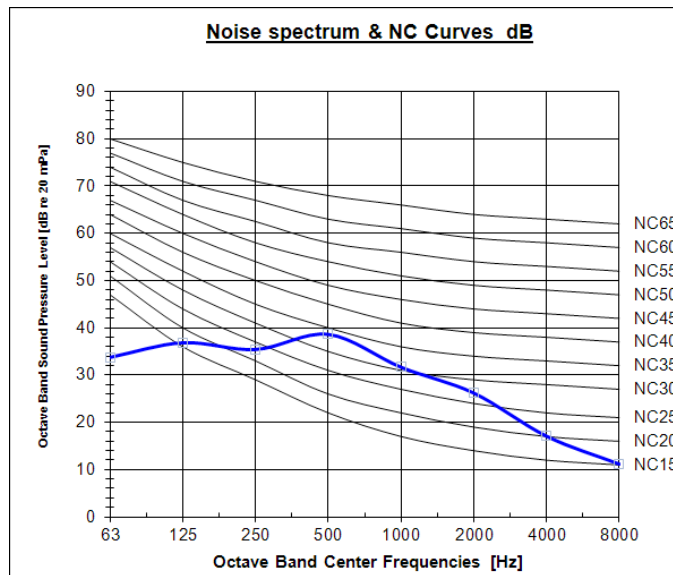

Model 12

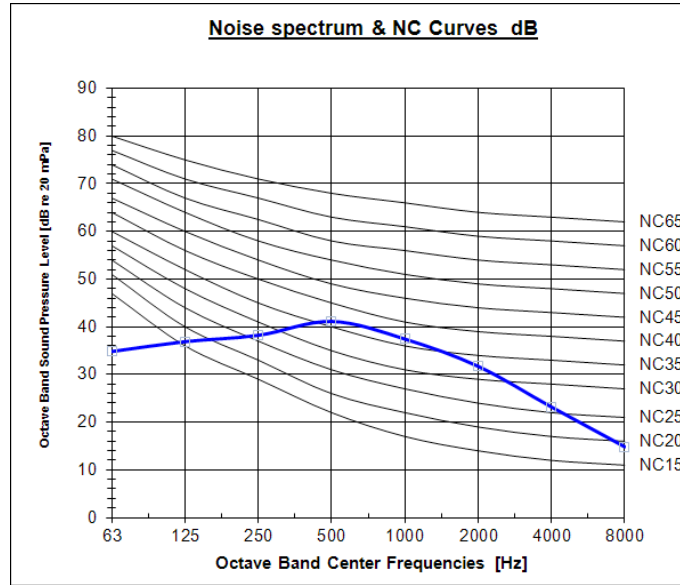

Model 18

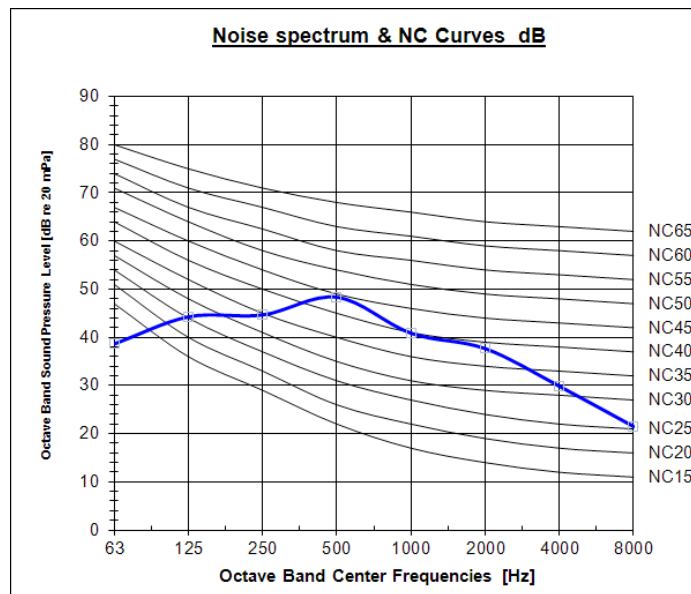

## ➔ 5.9 Two-way Cassette Type GMV-ND\*\*TS/A-T(U)

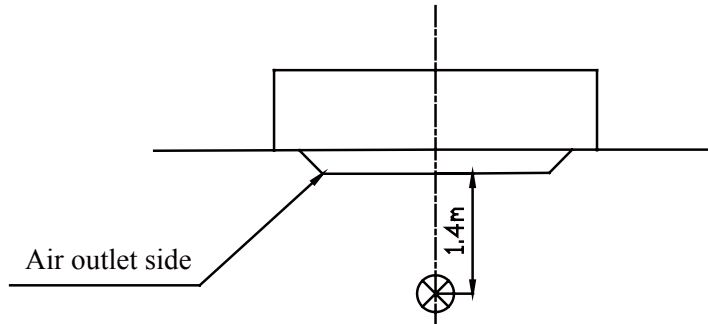

Transducer meter of sound level meter

**NOTICE!**

- ① The noise level is measured in the semi-anechoic room. It will be slightly higher due to change of the environment during actual operation.
- ② The noise level is measured under the standard test condition.

Model 09/18

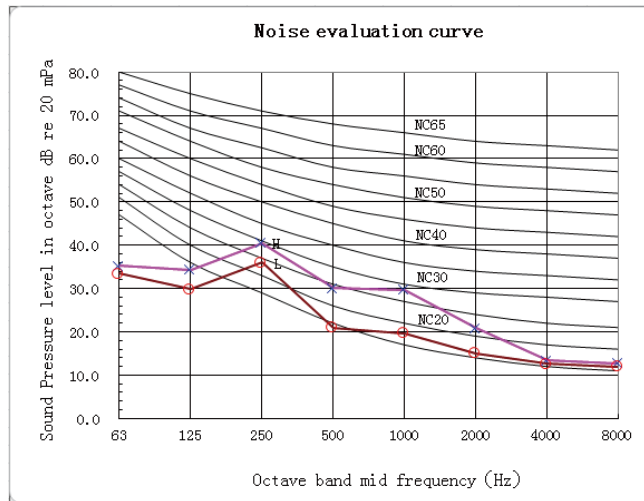

Model 24

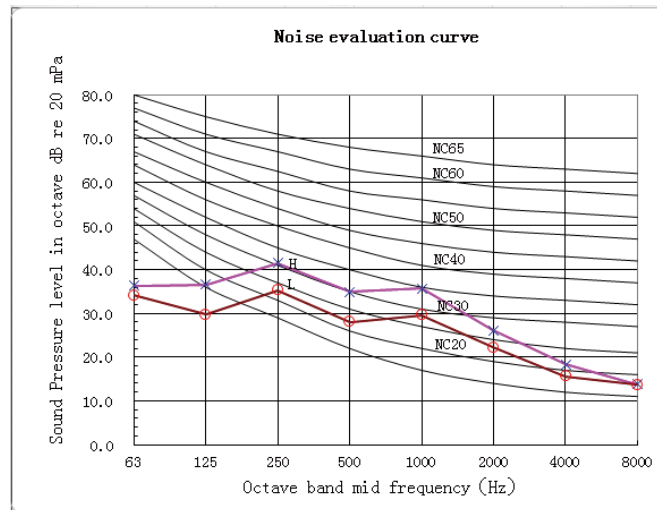

### 5.10 Compact Four-way Cassette Type GMV-ND\*\*T/B-T(U)

Model 07/12

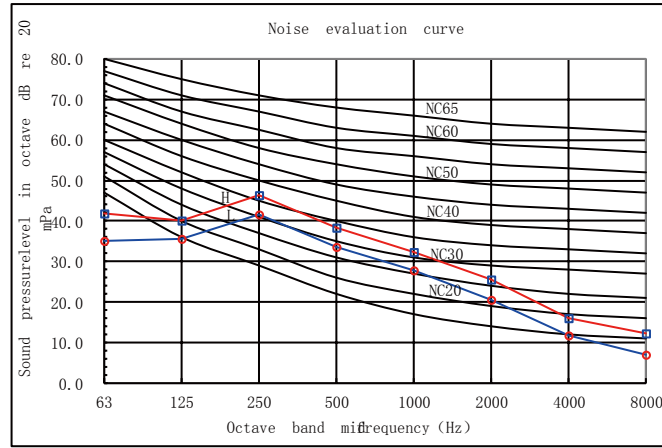

Model 15/18

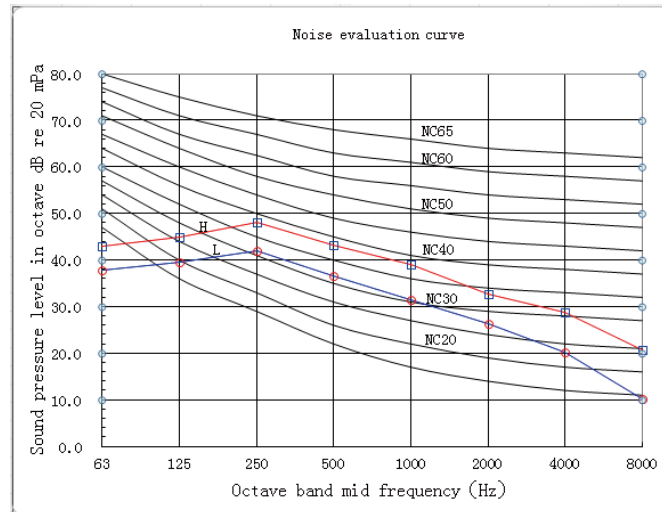

### 5.11 Super High Static Pressure Duct Type Indoor Unit GMV-ND\*\*PHS/B-T(U)

Model 07/09

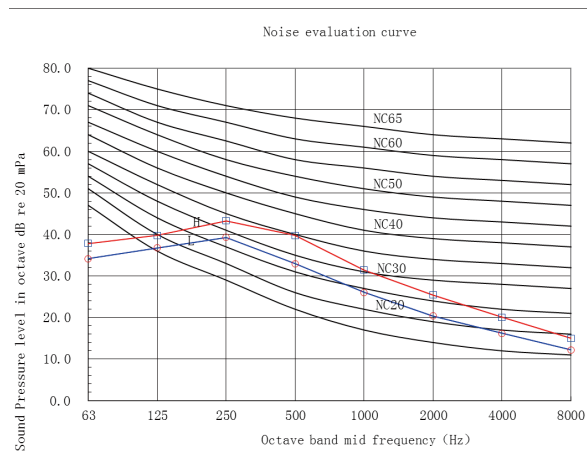



Model 12/15/18/22/24

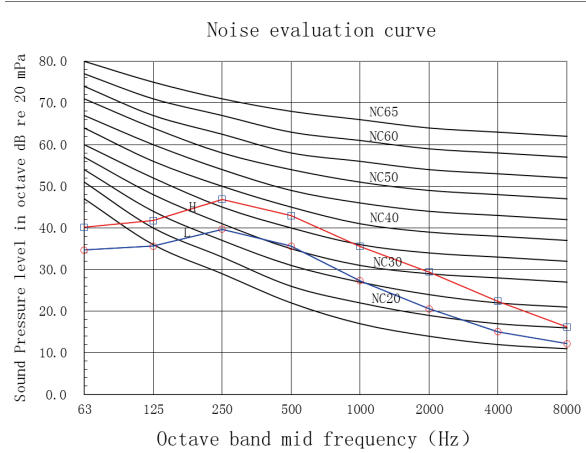

Model 30/36/42

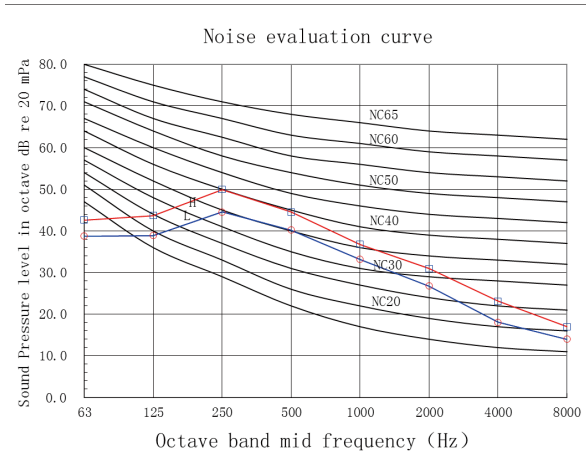

Model 48/54

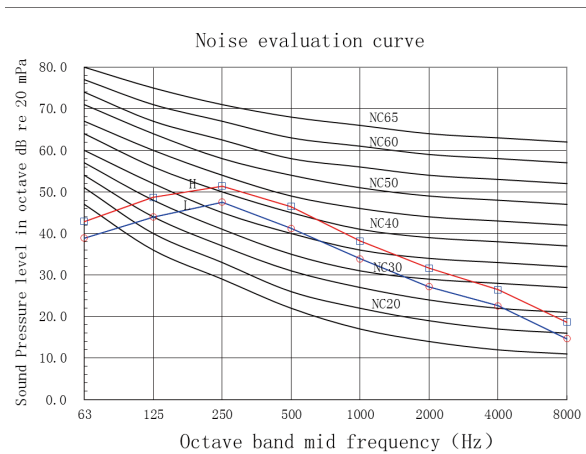

Model 72

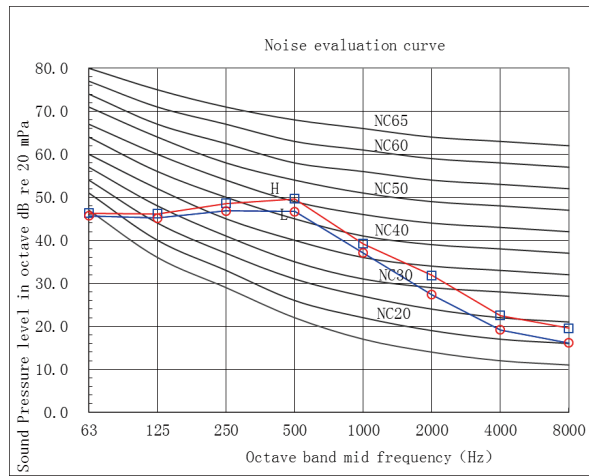

Model 96

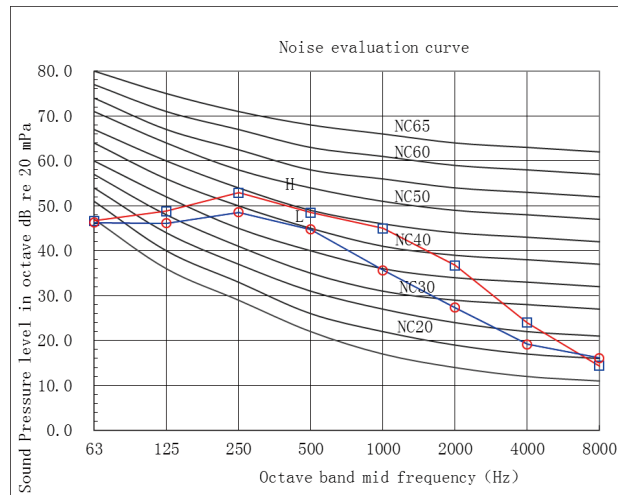

## ➔ 5.12 Air Handler type Indoor Unit GMV-ND\*\*A/A-T(U)

Model 09

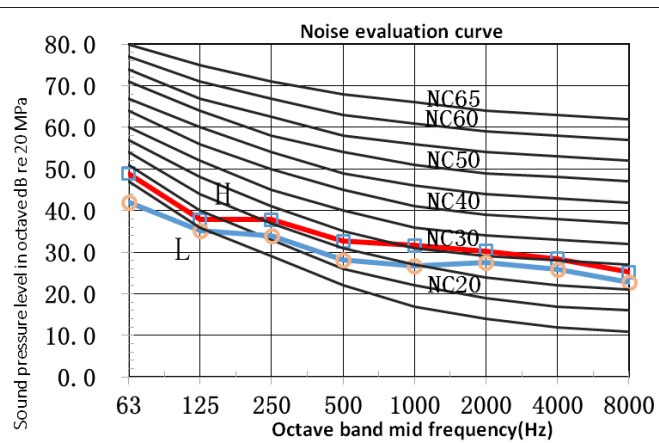

Model 12

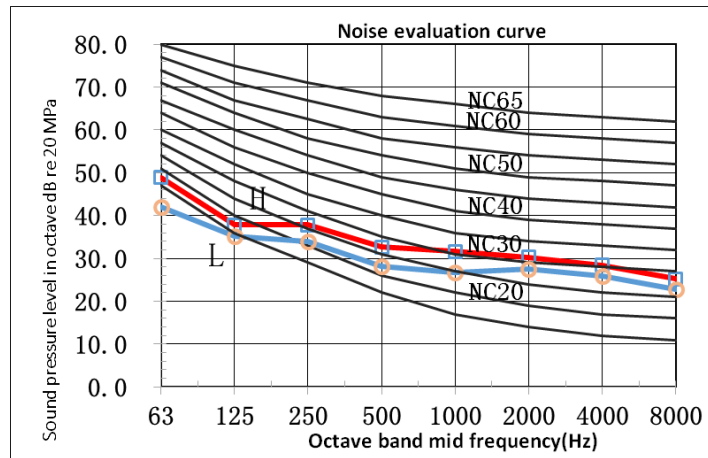

Model 18

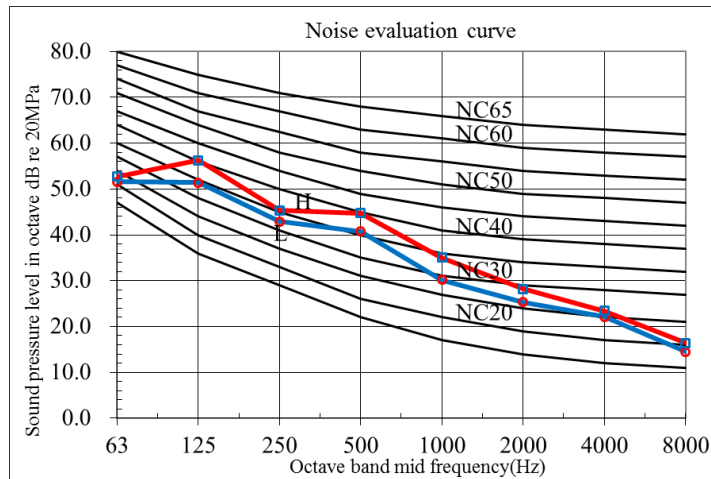

Model 24

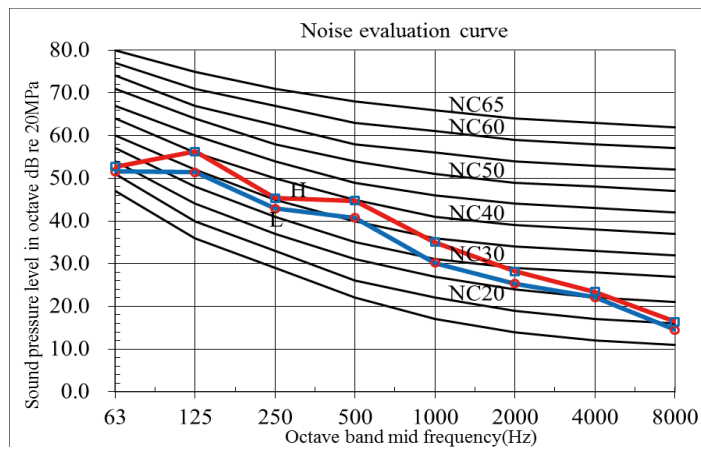

Model 30

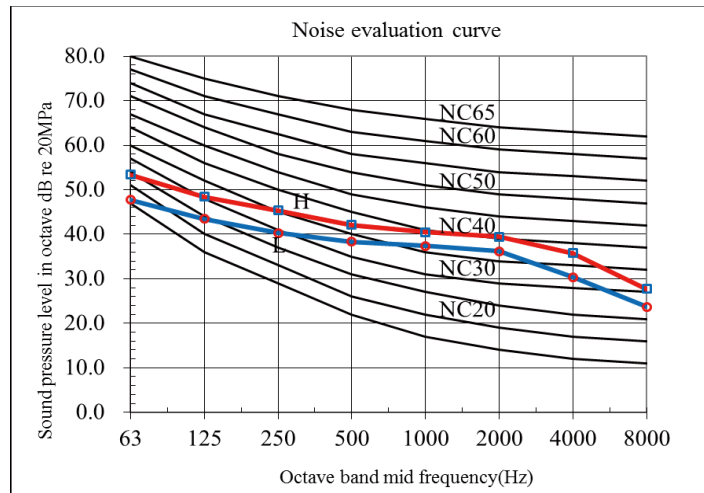

Model 36

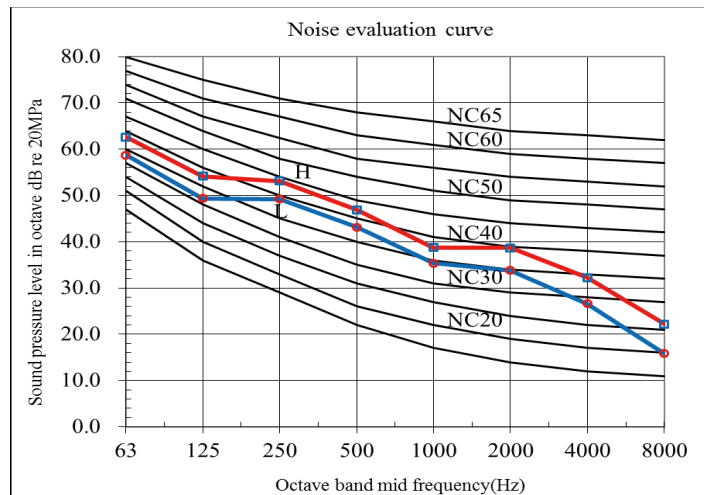

Model 42

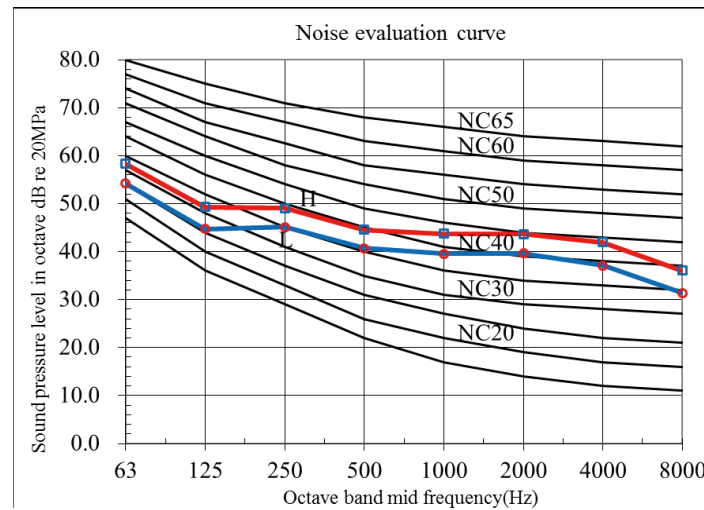

Model 48

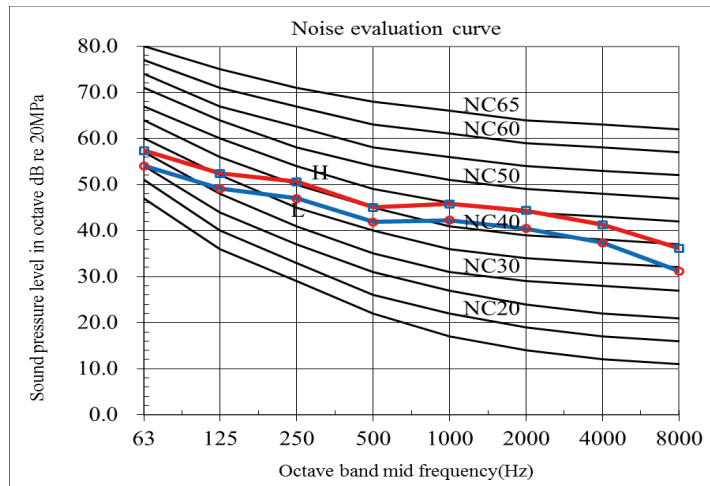

Model 54

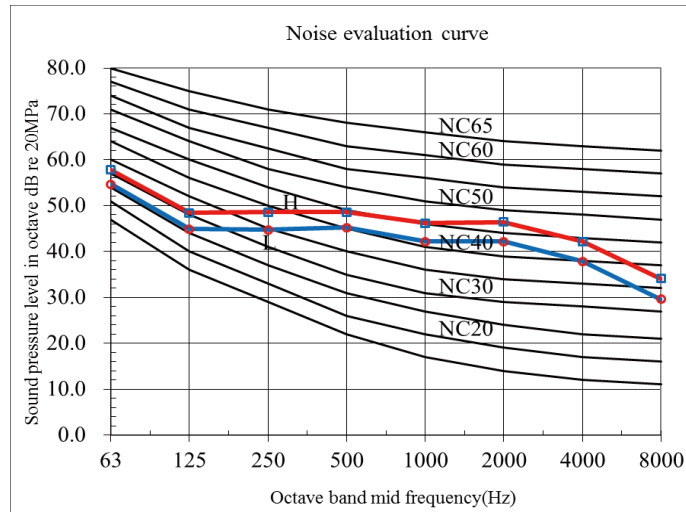

## ➔ 5.13 1-way Cassette Type

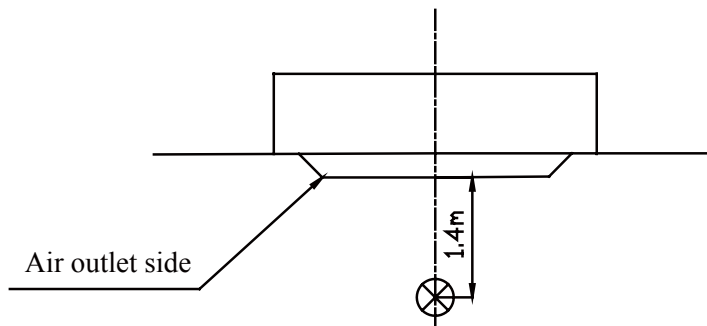

Transducer meter of sound level meter

### NOTICE!

- ① The noise level is measured in the semi-anechoic room. It will be slightly higher due to change of the environment during actual operation.
- ② The noise level is measured under the standard test condition.

Model 07/09

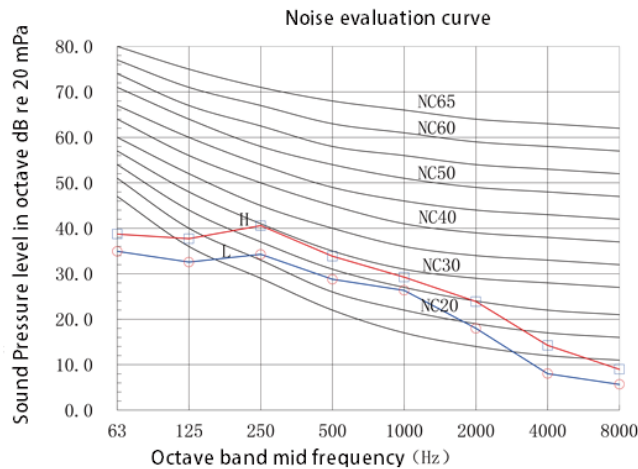

Model 12

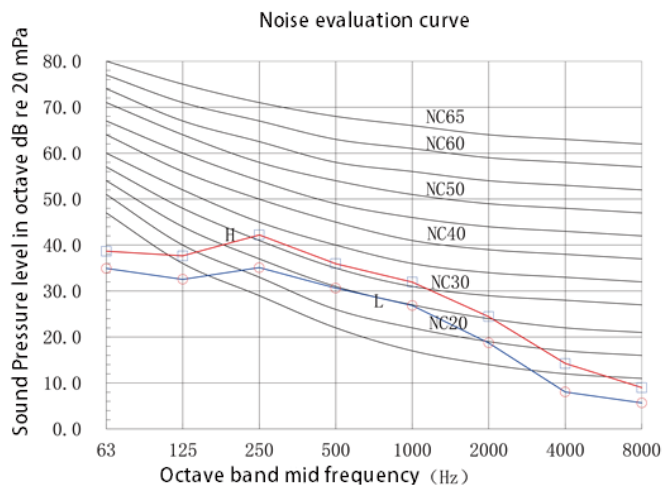

**5.14 Low Static Pressure Duct Type Indoor Unit GMV-ND\*\*PLS/C-T(U)**

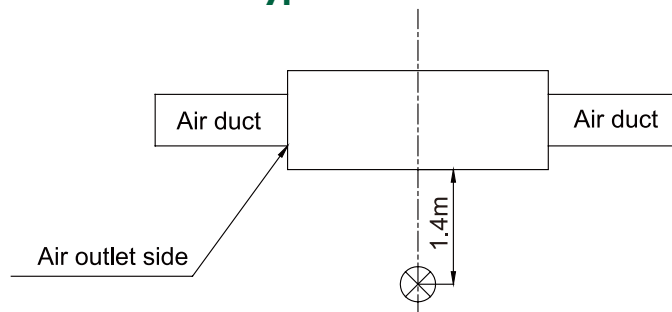

Transandient meter of sound level meter

NOTICE!

- ① The noise level is measured in the semi-anechoic room. It will be slightly higher due to change of the environment during actual operation.
- ② The noise level is measured under the standard test condition.
- ③ The noise level is measured under the condition of rear air return. The noise level will be a little higher if the lower air return mode is adopted.

Model GMV-ND30PLS/C-T(U), GMV-ND36PLS/C-T(U)

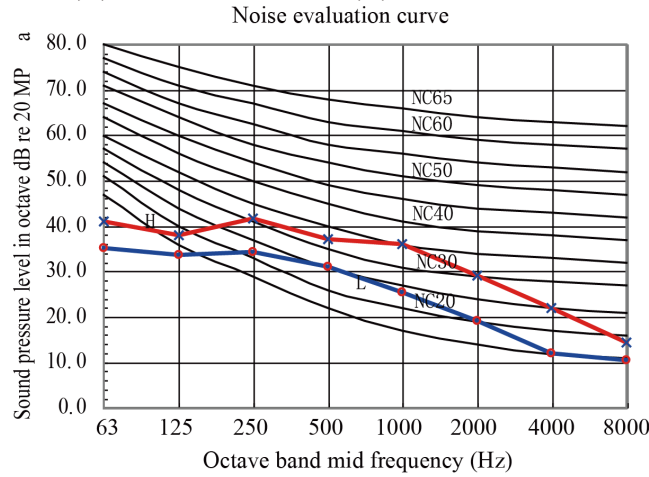

Model GMV-ND42PLS/C-T(U), GMV-ND48PLS/C-T(U)

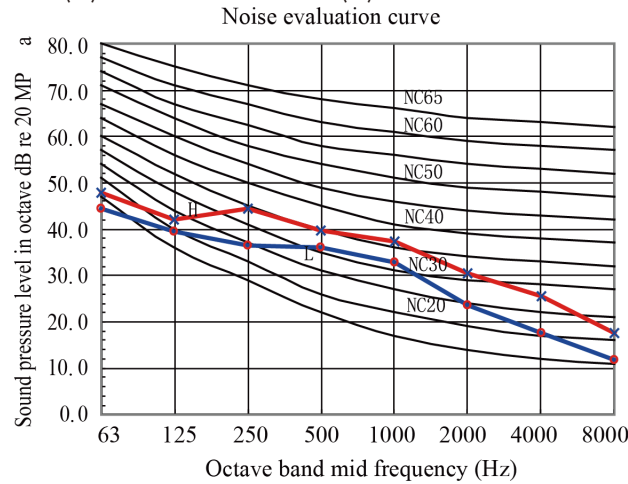

## 5.15 360° Air Discharge Compact Cassette Type

Model 05、07

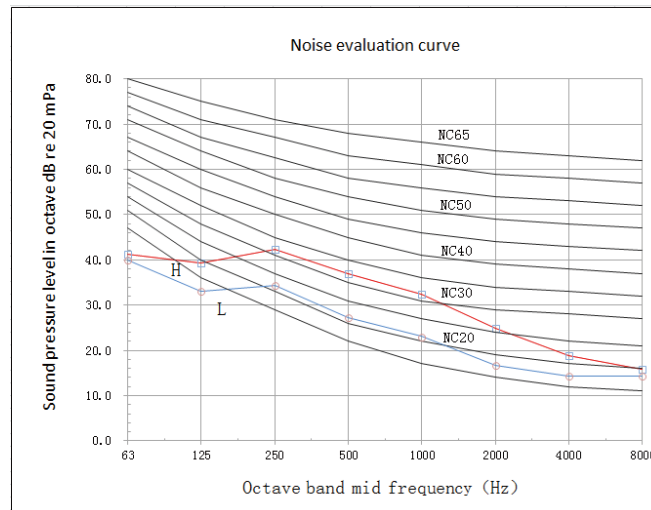

Model 09

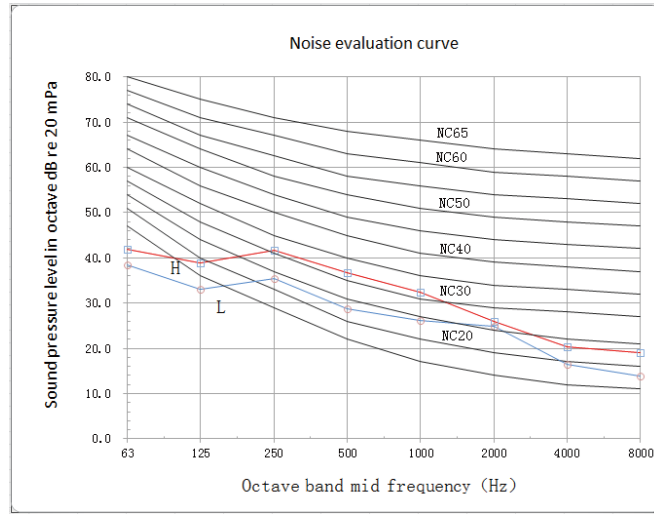

Model 12

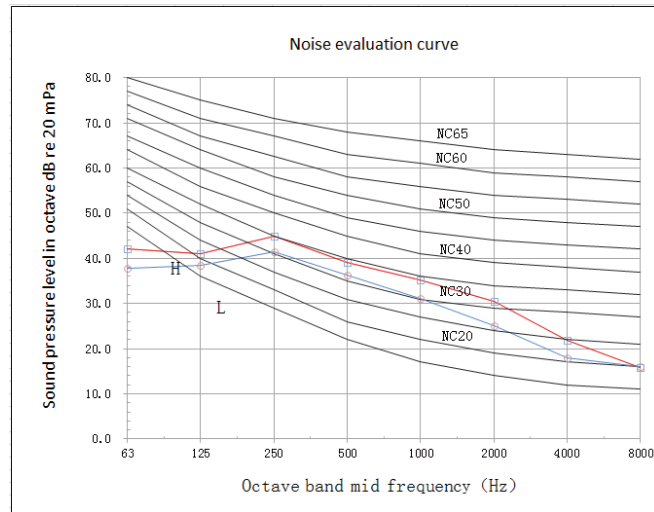

Model 15、18

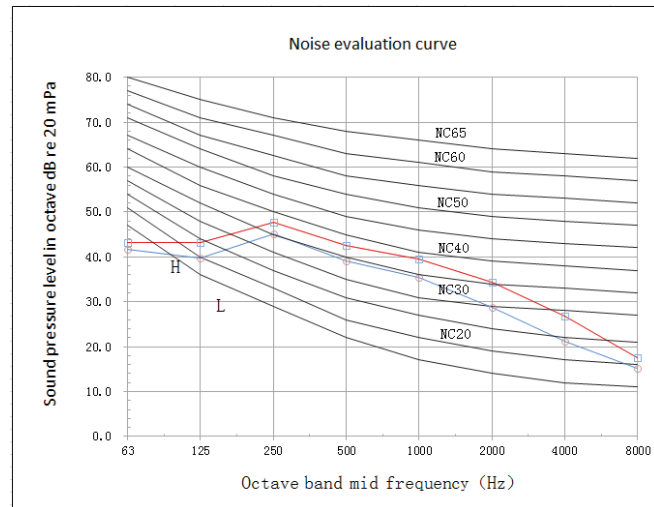



## 5.16 360° Air Discharge Cassette Type

Model 07-15

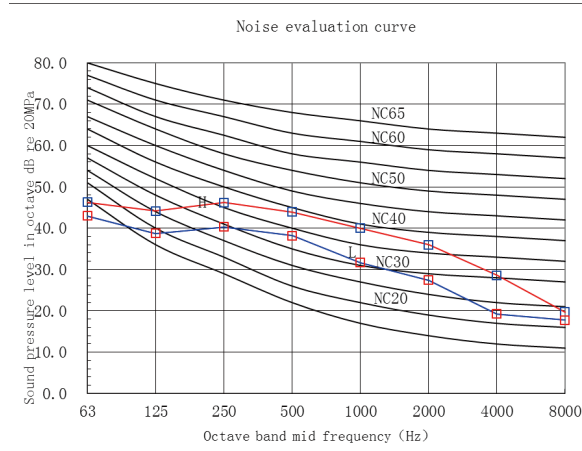

Model 18-24

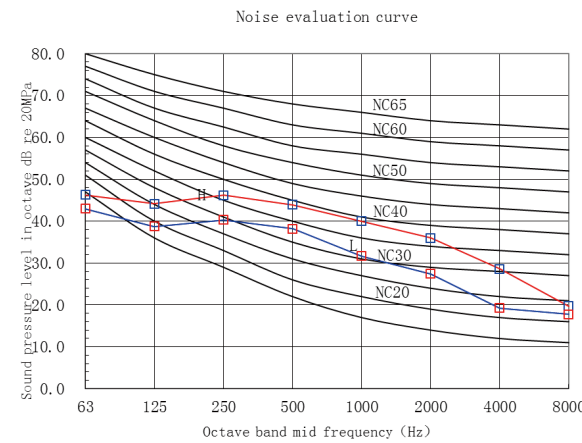

Model 30

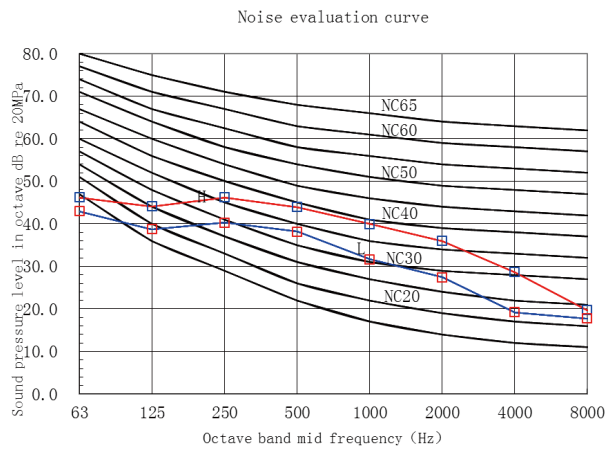

Model 36-48

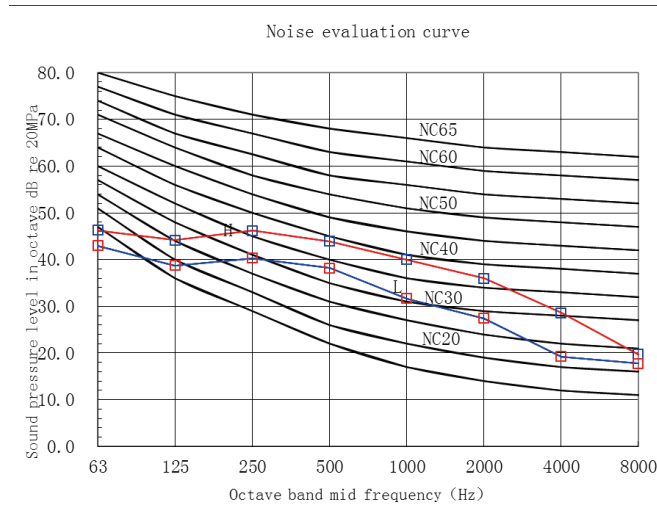

## 6 FAN CHARACTERISTICS

### 6.1 Low ESP Duct Type

GMV-ND07PLS/A-T(U)  
GMV-ND09PLS/A-T(U)

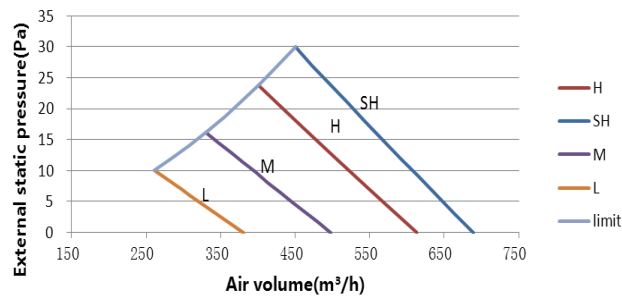

GMV-ND12PLS/A-T(U)

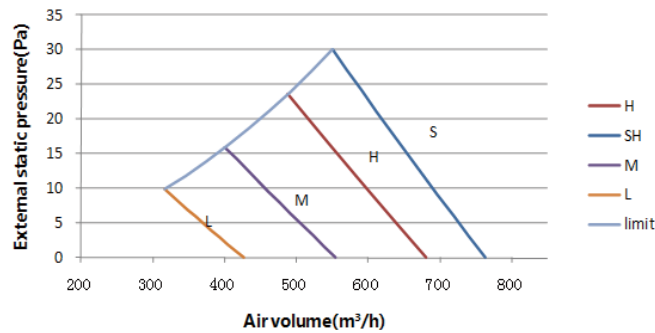

GMV-ND14PLS/A-T(U)

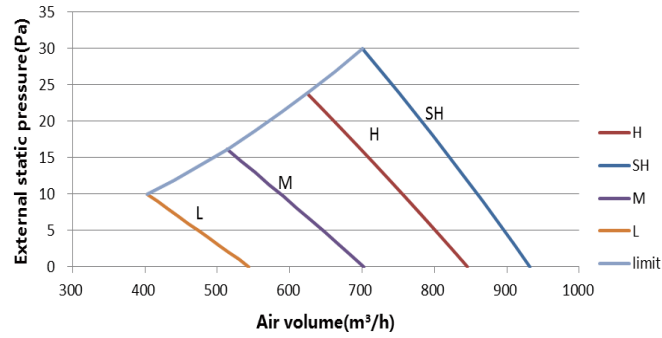

GMV-ND18PLS/A-T(U)  
GMV-ND22PLS/A-T(U)

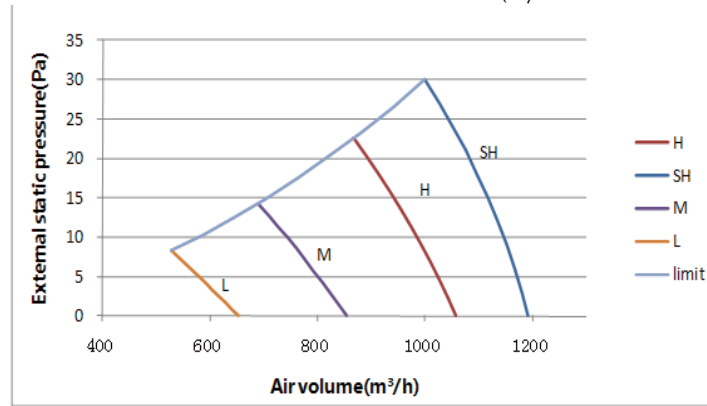

## ➔ 6.2 Slim Duct Type Indoor Unit

GMV-ND07PLS/B-T(U)  
GMV-ND09PLS/B-T(U)

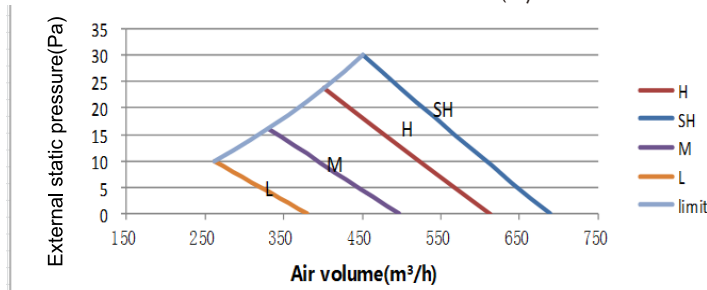

GMV-ND12PLS/B-T(U)

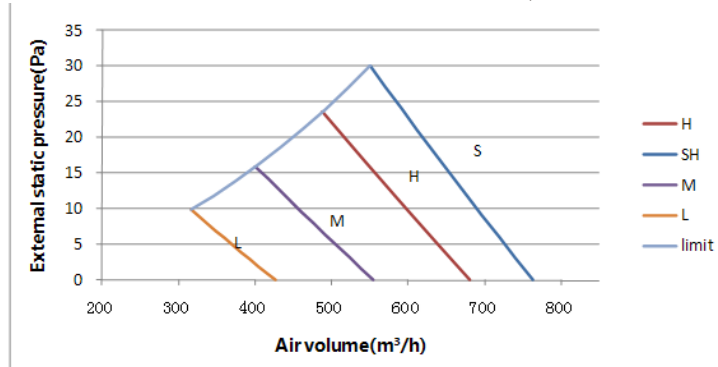

GMV-ND14PLS/B-T(U)

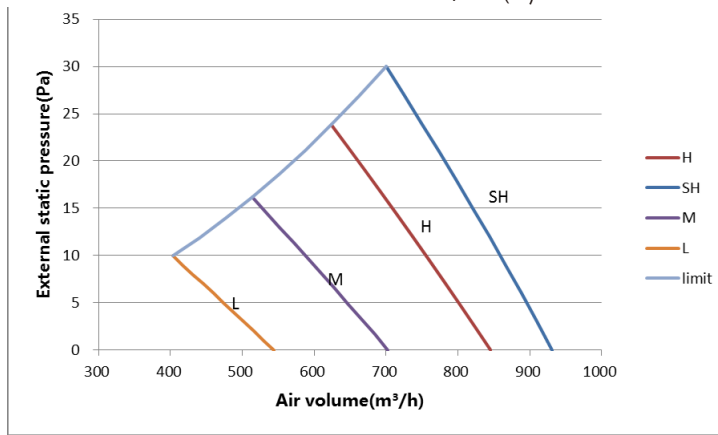

GMV-ND18PHS/A-T(U)  
GMV-ND24PHS/A-T(U)

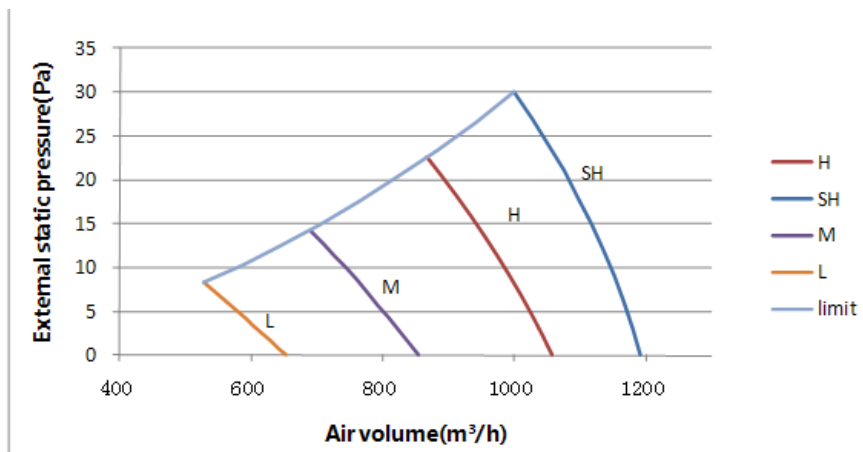

## 6.3 High ESP Duct Type

GMV-ND18PHS/A-T(U)  
GMV-ND24PHS/A-T(U)

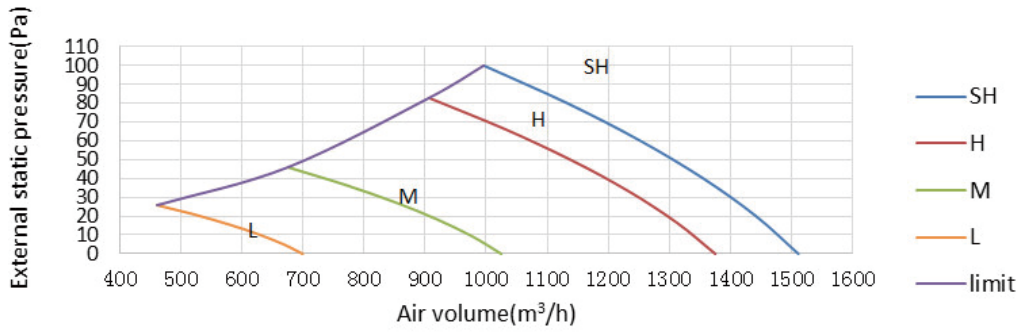

GMV-ND30PHS/A-T(U)  
GMV-ND36PHS/A-T(U)

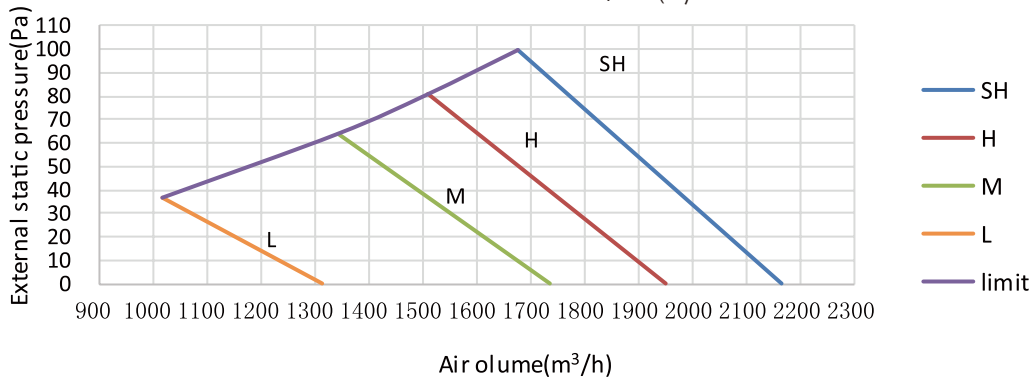

GMV-ND42PHS/A-T(U)

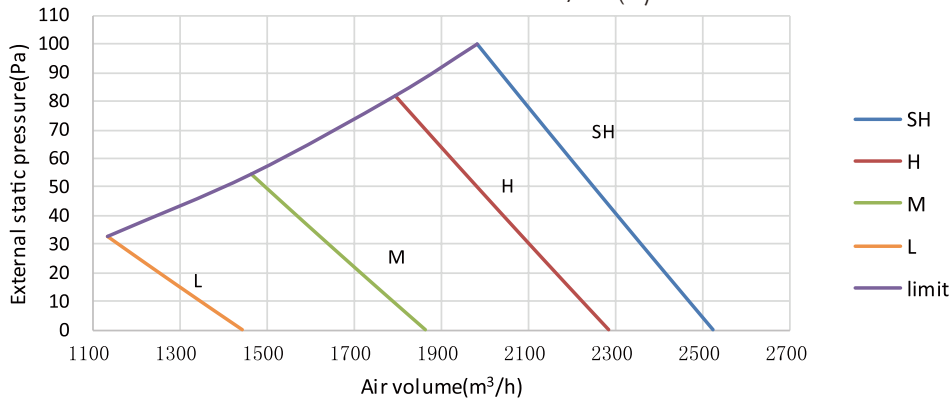

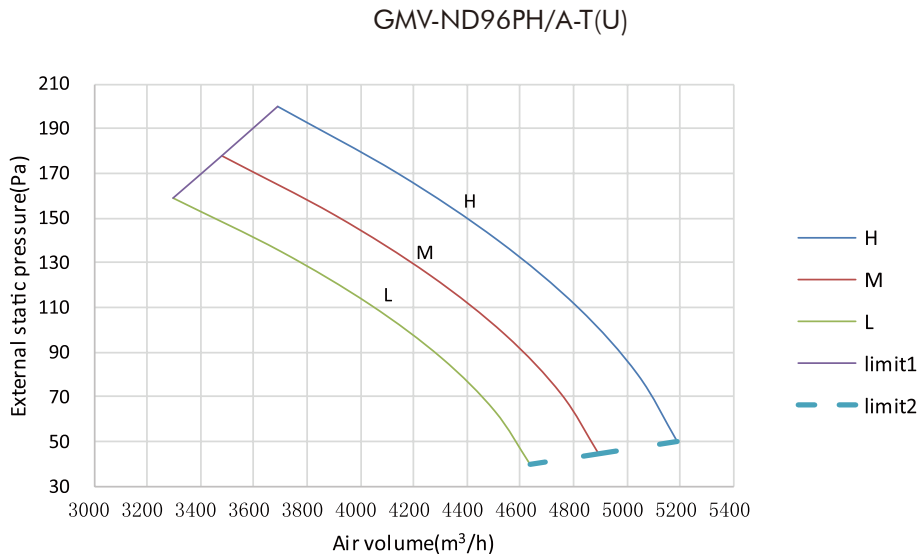
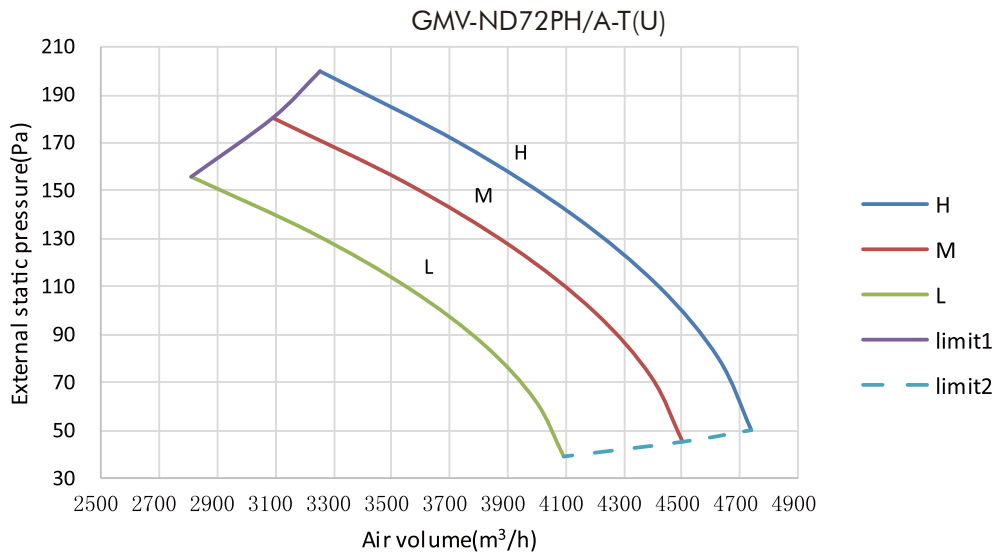
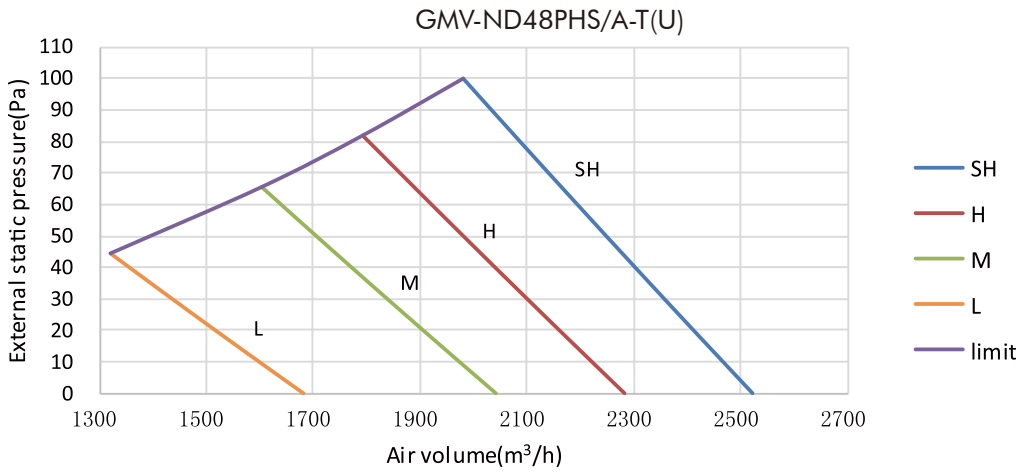

## 6.4 Fresh Air Processing Indoor Unit

When this unit is installed, select the static pressure according to the actual air volume from 2000~3500m<sup>3</sup>/h . There're 13 static pressure notches for selection. Please refer to the Installation, Debugging and Maintenance Manual for the adjustment method for the static pressure. The curve diagram between air volume and static pressure is as below. The corresponding static pressure is from notch 1 to notch 13 for the curve from lower to upper side.

GMV-NDX42P/A-T(U), GMV-NDX48P/A-T(U)

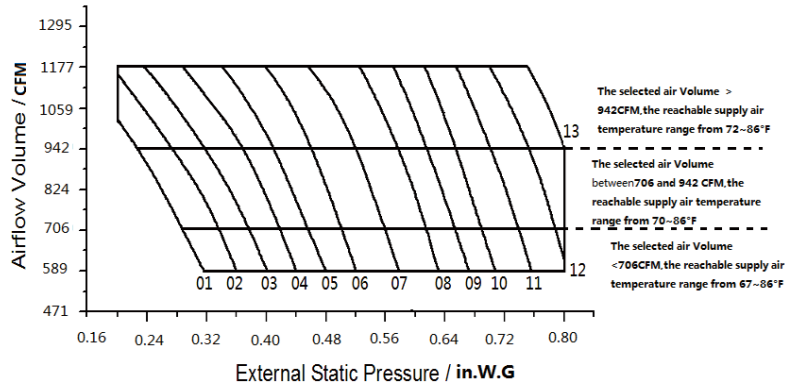

GMV-NDX54P/A-T(U), GMV-NDX72P/A-T(U)

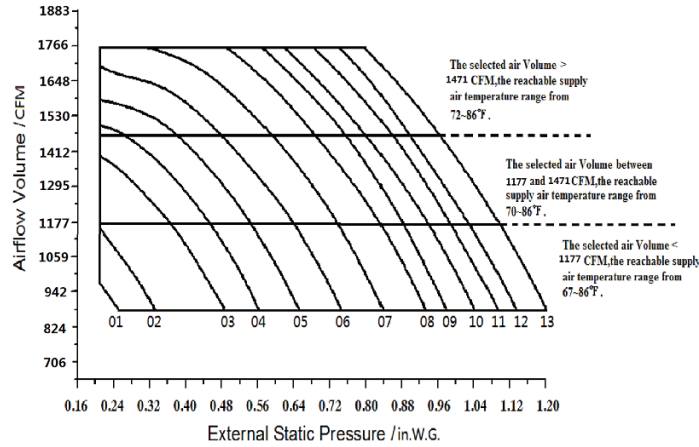

GMV-NDX96P/A-T(U)

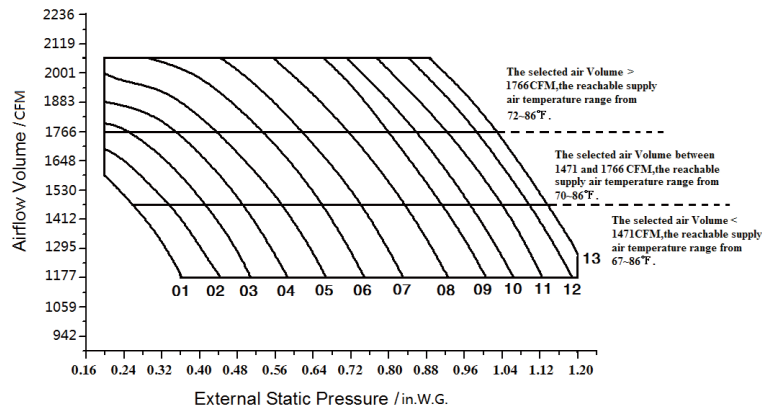

## 6.5 Air Handler Type Indoor Unit

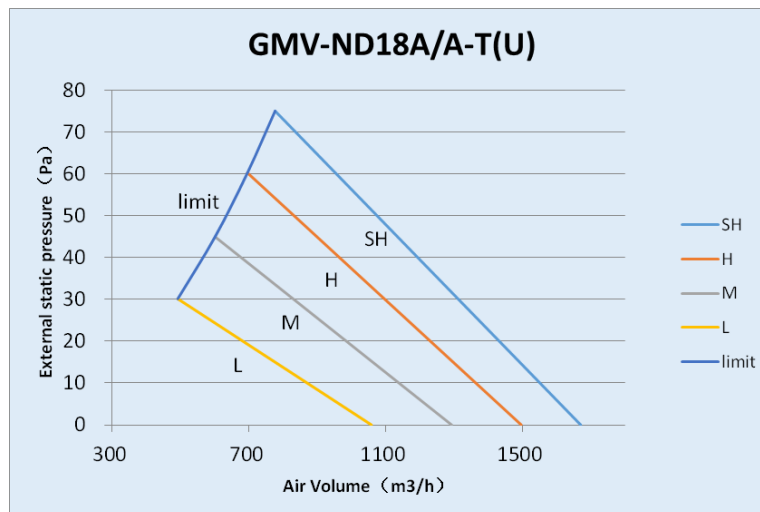
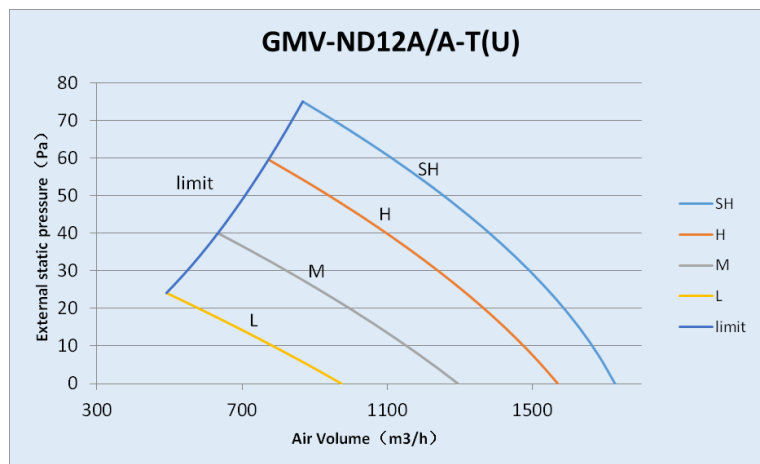
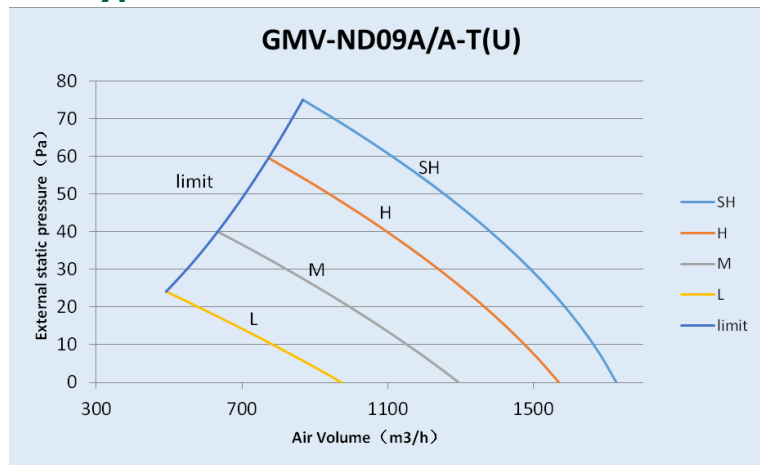



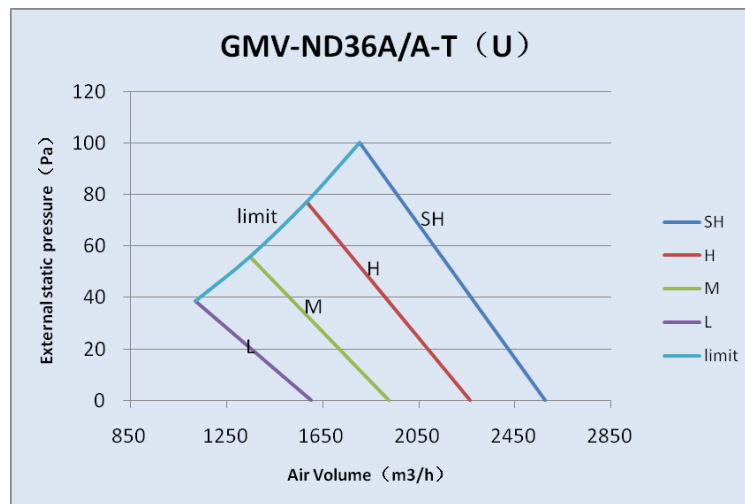
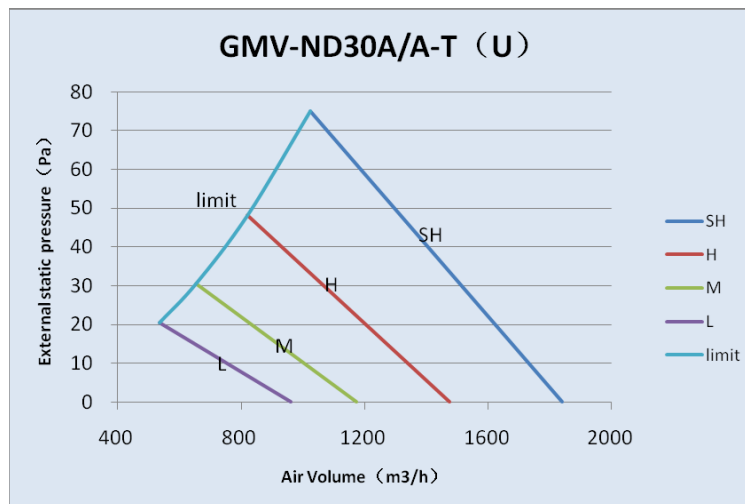
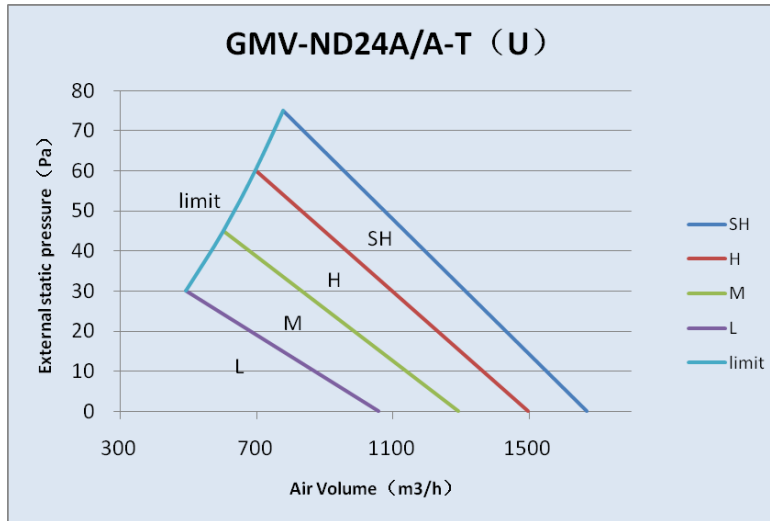

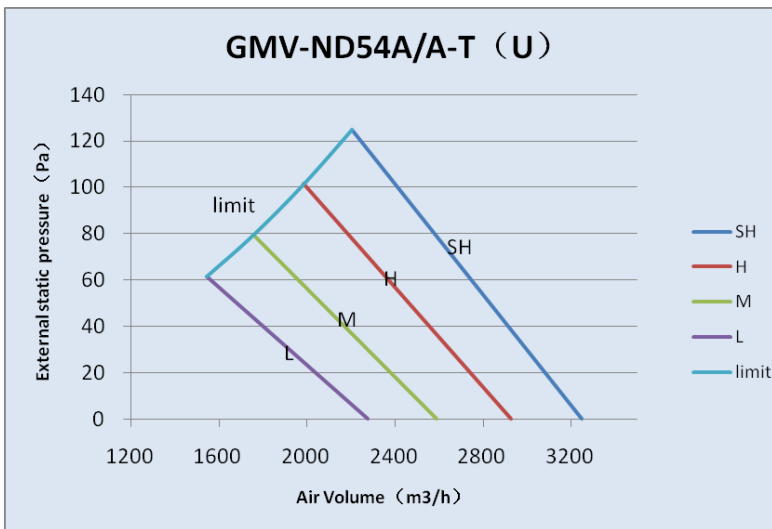
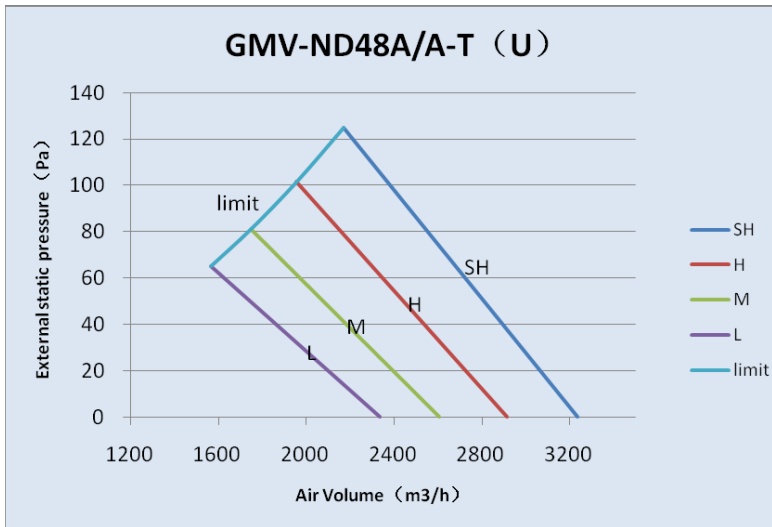
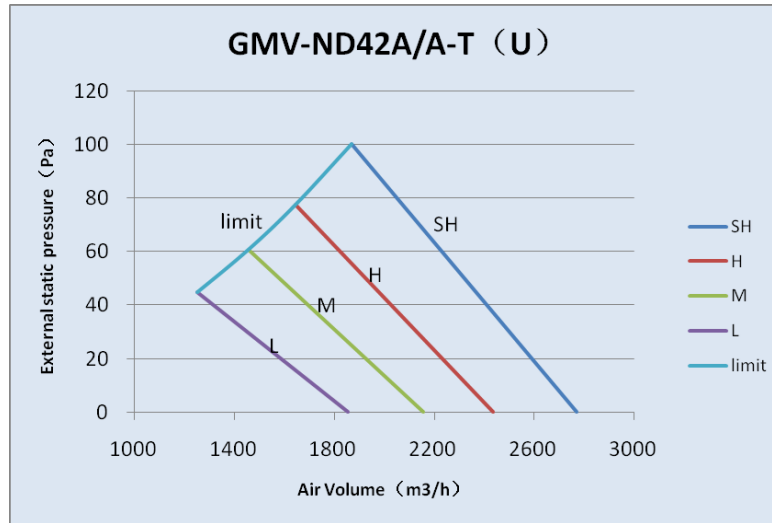

## ➔ 6.6 Low Static Pressure Duct Type Indoor Unit GMV-ND\*\*PLS/C-T(U)

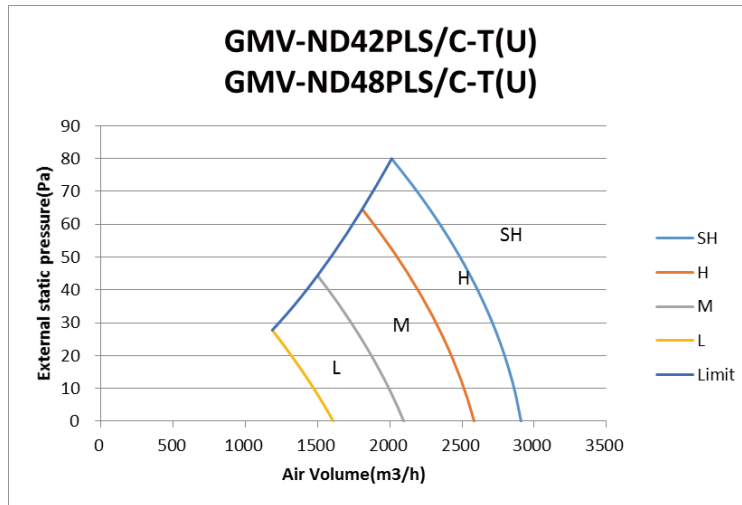
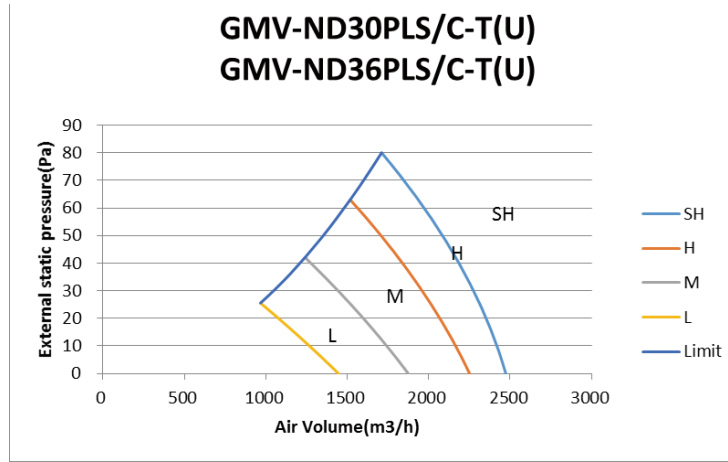

# 7 UNIT INSTALLATION SPACE REQUIREMENTS

## 7.1 Precautions On The Indoor Unit Design

- The following aspects must be specially noted in consideration of the indoor unit location:
- (1) The location should satisfy the optimal airflow organization for air conditioner in the actual project, and implement the most uniform distribution of temperature.
  - (2) Avoid mixed use of air ducts for air supply and air return in different air conditioning areas.
  - (3) When the indoor unit in the air supply mode of air duct is selected, it is preferred to adopt the rear air return mode for the unit to further efficiently reduce the air return noise of the unit.

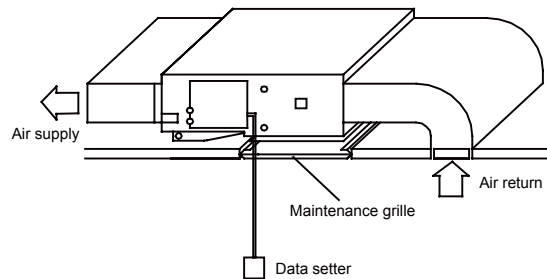

- (4) In locating, consider whether air return of the unit will be affected. For the indoor unit in the air supply mode of air duct, the air return frame must be more than 300 mm away from the back wall (rear air return mode) or other barriers.
- (5) If the unit uses the rear air return mode and the ceiling uses the air return mode directly below the unit, the distance between the unit bottom and the ceiling must be over 50 mm. Meanwhile, the effective circulation area between the unit bottom and the ceiling cannot be smaller than the air return vent area of the unit. For example:

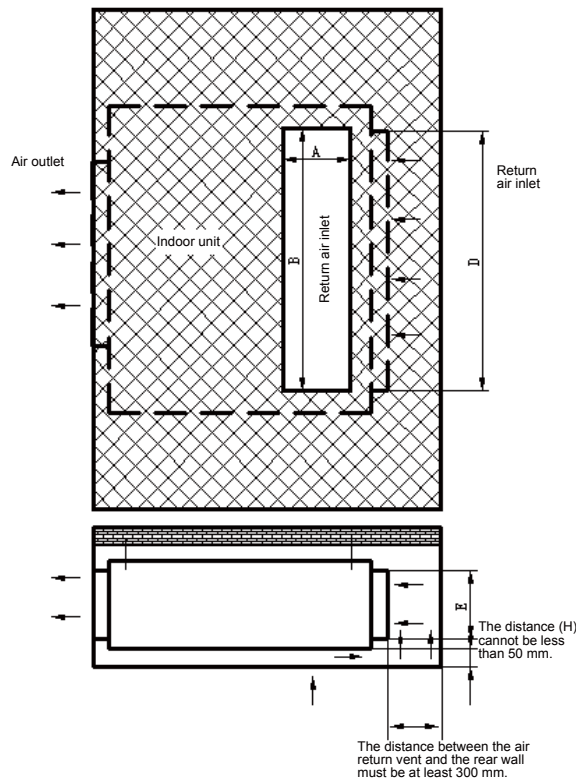

Air return area of the unit:  $S1 = D \times E$

Air return vent circumference of the ceiling:  $L = 2 \times (A+B)$

Effective air return area of the ceiling:  $S2 = L \times H$

$S2$  cannot be smaller than  $S1$ . The distance  $H$  between the ceiling and the unit cannot be smaller than 50 mm.

(6) No barrier blocking air flow should exist at the air inlet or outlet of the indoor unit. The indoor unit should be installed at a position 2.3 m higher than the floor.

(7) For the indoor unit with the rated Cooling capacity greater than 5.6 kW, an air supply duct should be additionally added, and the air duct and air outlet should be set properly to reduce noises.

(8) A sufficient maintenance space should be reserved in locating the unit.

## 7.2 Different Installation Space Requirements For Various Of Indoor Units

### 7.2.1 Low ESP Duct Unit Series

(1) Outline and installation dimension

The following diagram is applicable for units with the cooling capacity ranging from 7kBtu/h to 22kBtu/h.

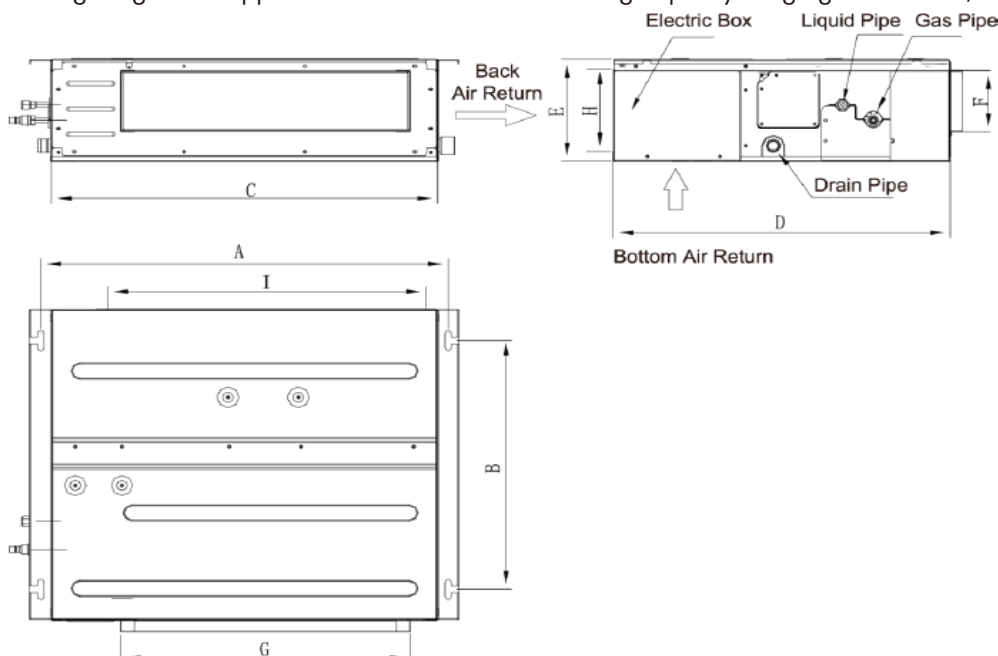

The table below lists the detailed dimensions.

Unit: mm(in.)

Item	A	B	C	D	E	F	G	H	I
Model									
GMV-ND07PLS/A-T(U)	742	491	700	615	200	121	528	161	580
GMV-ND09PLS/A-T(U)	(29	(19	(27 1/2)	(24 1/4)	(7 7/8)	(4 3/4)	(20	(6 5/16)	(22
GMV-ND12PLS/A-T(U)	3/16)	5/16)					13/16)		13/16)
GMV-ND14PLS/A-T(U)	942	491	900	615	200	121	728	161	780
	(37	(19	(35 3/8)	(24 1/4)	(7 7/8)	(4 3/4)	(28	(6 5/16)	(30
	1/16)	5/16)					11/16)		11/16)
GMV-ND18PLS/A-T(U)	1142	491	1100	615	200	121	928	161	980
GMV-ND22PLS/A-T(U)	(44	(19	(43 1/4)	(24 1/4)	(7 7/8)	(4 3/4)	(36	(6 5/16)	(38
	15/16)	5/16)					9/16)		9/16)

(2) Installation space

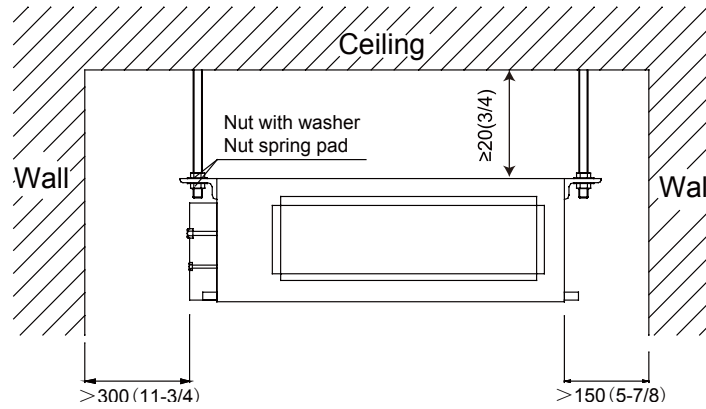

### 7.2.2 Slim Duct Type Indoor Unit

Outline and installation dimension

The following diagram is applicable for units with the cooling capacity ranging from 7kBtu/h to 24kBtu/h

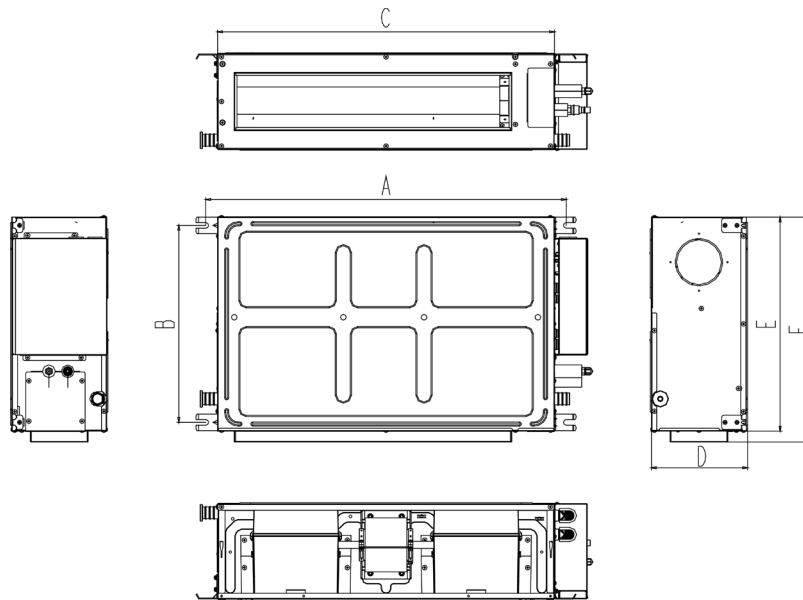

Model \ Item	A	B	C	D	E	F
GMV-ND07~12PLS/B-T(U)	760(30)	415(16-1/3)	710(28)	200(17-5/7)	462(18-3/16)	486(19-2/16)
GMV-ND14~18PLS/B-T(U)	1060(41-3/4)	415(16-1/3)	1010(39-3/4)	200(17-5/7)	462(18-3/16)	486(19-2/16)
GMV-ND24PLS/B-T(U)	1360(53-1/2)	415(16-1/3)	1310(39-3/4)	200(17-5/7)	462(18-3/16)	486(19-2/16)

## 7.2.3 High ESP Duct Type Series

(1) Outline and installation dimension

The following diagram is applicable for units with the cooling capacity ranging from 18 kBtu/h to 48 k Btu/h.

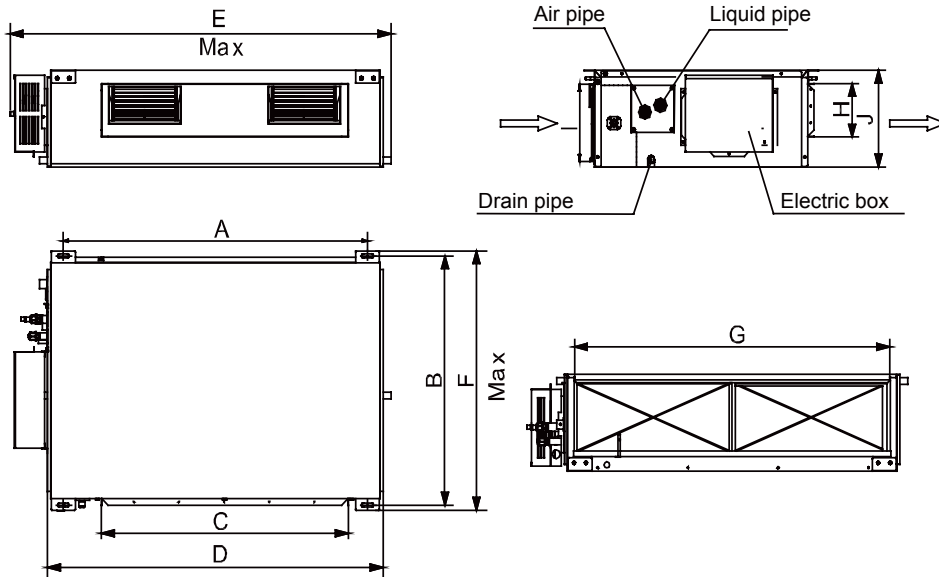

Below are dimensions of A, B, C, etc. for different models:

Unit: mm(in.)

Model	A	B	C	D	E	F	G	H	I	J
GMV-ND18PHS/A-T(U)	1101	517	820	1159	1271	558	1002	160	235	268
GMV-ND24PHS/A-T(U)	(43-3/8)	(20-3/8)	(32-1/4)	(45-5/8)	(50)	(22)	(39-1/2)	(6-1/4)	(9-1/4)	(10-1/2)
GMV-ND30PHS/A-T(U)	1011	748	820	1115	1229	775	979	160	231	290
GMV-ND36PHS/A-T(U)	(39-3/4)	(29-1/2)	(32-1/4)	(43-7/8)	(48-3/8)	(30-1/2)	(38-1/2)	(6-1/4)	(9-1/8)	(11-3/8)
GMV-ND42PHS/A-T(U)										
GMV-ND48PHS/A-T(U)										

The following diagram is applicable for units with the cooling capacity 72、96kBtu/h.

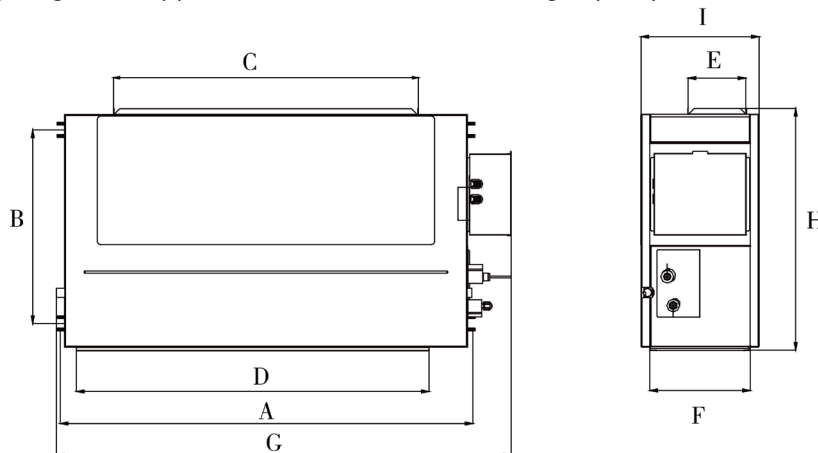

Below are dimensions of A, B, C, etc. for different models:

Unit: mm(in.)

Model	A	B	C	D	E	F	G	H	I
GMV-ND72H/A-T(U)	1353 (53-1/4)	632 (24-7/8)	992 (39)	1150 (45-1/4)	192 (7-1/2)	327 (12-7/8)	1483 (58-3/8)	791 (31-1/8)	385 (15-1/8)
GMV-ND96PH/A-T(U)	1563 (61-1/8)	706 (27-3/4)	992 (39)	1350 (53-1/8)	192 (7-1/2)	402 (15-7/8)	1686 (66-3/8)	870 (34-1/4)	450 (17-3/4)

(2) Installation space

GMV-ND18PHS/A-T(U) - GMV-ND48PHS/A-T(U)

Unit: mm(in.)

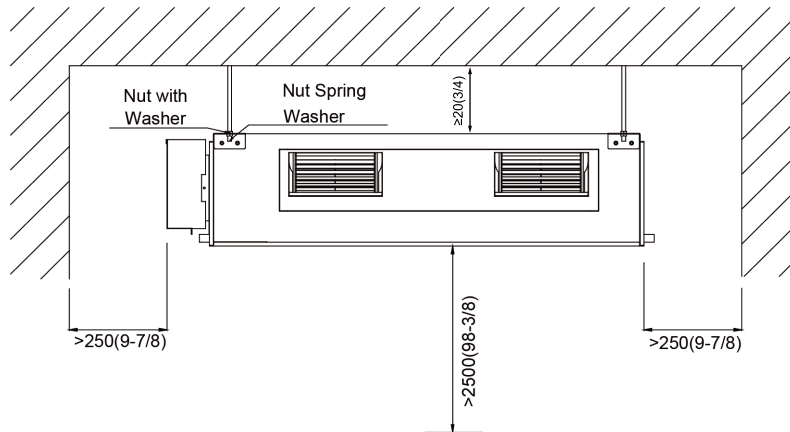

GMV-ND72PH/A-T(U), GMV-ND96PH/A-T(U)

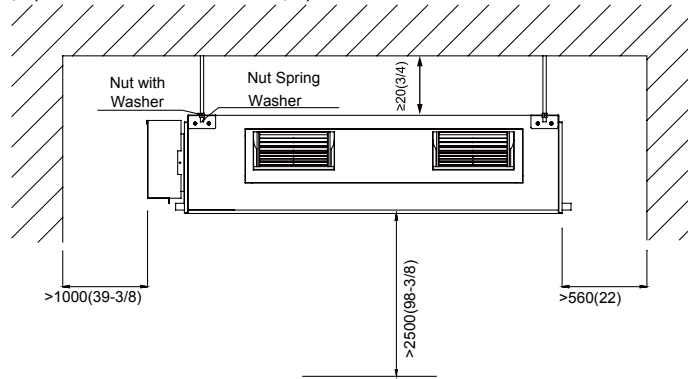



## 7.2.4 Four-way Cassette Indoor Unit

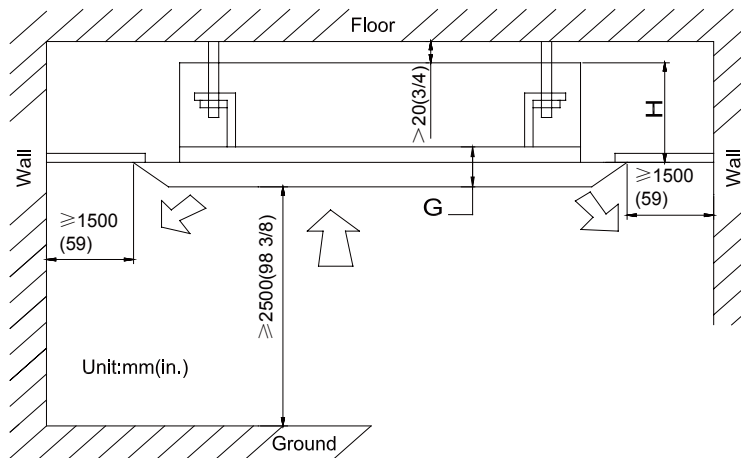
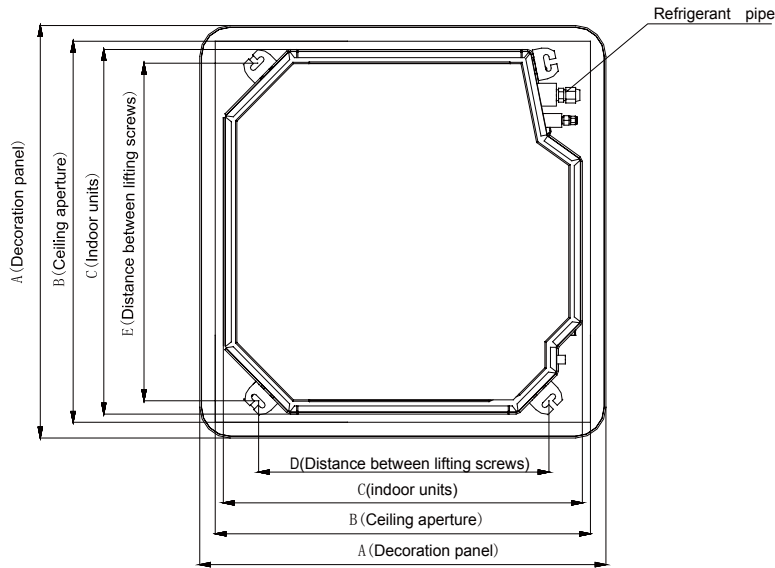

Unit: mm(in.)

Model	A	B	C	D	E	G	H
GMV-ND07T/A-T(U)	950 (37 3/8)	890 (35)	840 (33)	680 (26 3/4)	780 (30 3/4)	65 (2 1/2)	210 (8 1/4)
GMV-ND09T/A-T(U) GMV-ND12T/A-T(U) GMV-ND15T/A-T(U) GMV-ND18T/A-T(U) GMV-ND24T/A-T(U)	950 (37 3/8)	890 (35)	840 (33)	680 (26 3/4)	780 (30 3/4)	65 (2 1/2)	260 (10 1/4)
GMV-ND30T/A-T(U) GMV-ND36T/A-T(U) GMV-ND42T/A-T(U) GMV-ND48T/A-T(U)	950 (37 3/8)	890 (35)	840 (33)	680 (26 3/4)	780 (30 3/4)	65 (2 1/2)	340 (13 3/8)

### 7.2.5 Fresh Air Processing Unit

(1) Outline and installation dimension

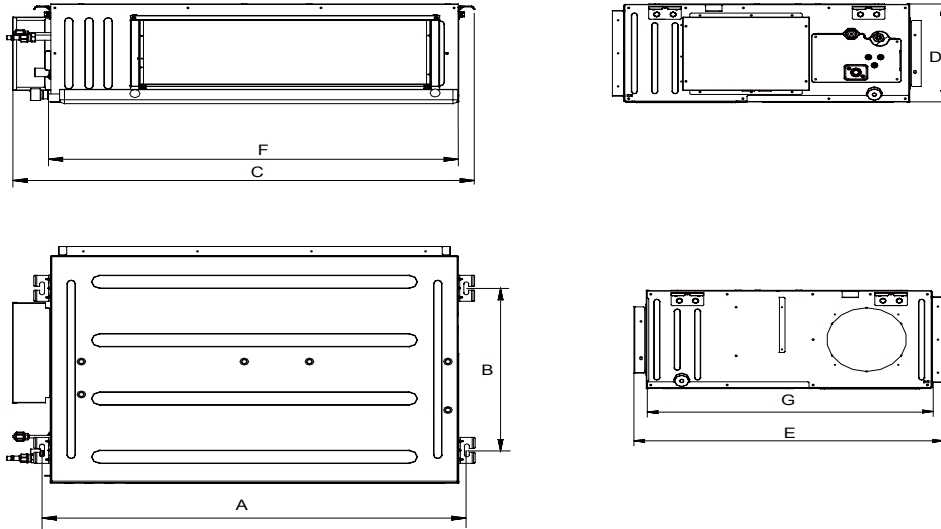

The table below lists the detailed dimensions.

Unit: mm(in.)

Model	A	B	C	D	E	F	G
GMV-NDX42P/A-T(U)	1440 (56-11/16)	500 (19-11/16)	1580 (62-7/32)	300 (11-13/16)	754 (29-11/16)	1400 (55-1/8)	700 (27-9/16)
GMV-NDX48P/A-T(U)	1440 (56-11/16)	500 (19-11/16)	1580 (62-7/32)	300 (11-13/16)	754 (29-11/16)	1400 (55-1/8)	700 (27-9/16)

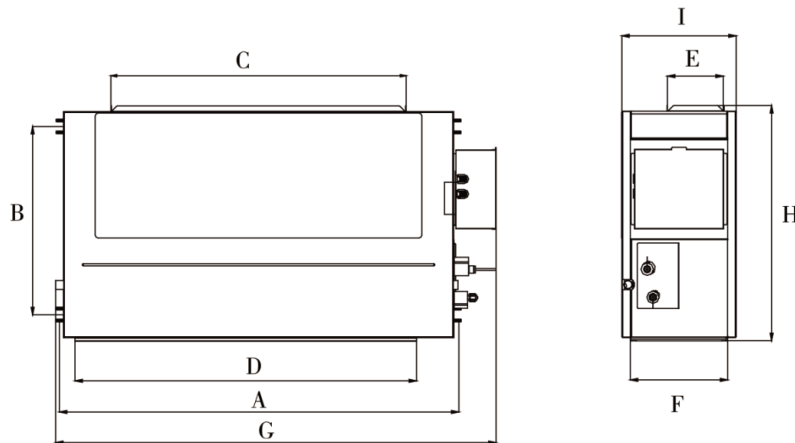

The table below lists the detailed dimensions.

Unit: mm(in.)

Item Model	A	B	C	D	E	F	G	H	I
GMV-NDX54P/A-T(U)	1353 (53-1/4)	632 (24-7/8)	992 (39)	1150 (45-1/4)	192 (7-1/2)	327 (12-7/8)	1483 (58-3/8)	791 (31-1/8)	385 (15-3/16)
GMV-NDX72P/A-T(U)	1353 (53-1/4)	632 (24-7/8)	992 (39)	1150 (45-1/4)	192 (7-1/2)	327 (12-7/8)	1483 (58-3/8)	791 (31-1/8)	385 (15-3/16)
GMV-NDX96P/A-T(U)	1353 (53-1/4)	632 (24-7/8)	992 (39)	1150 (45-1/4)	192 (7-1/2)	327 (12-7/8)	1483 (58-3/8)	791 (31-1/8)	385 (15-3/16)

## (2) Installation Spaces

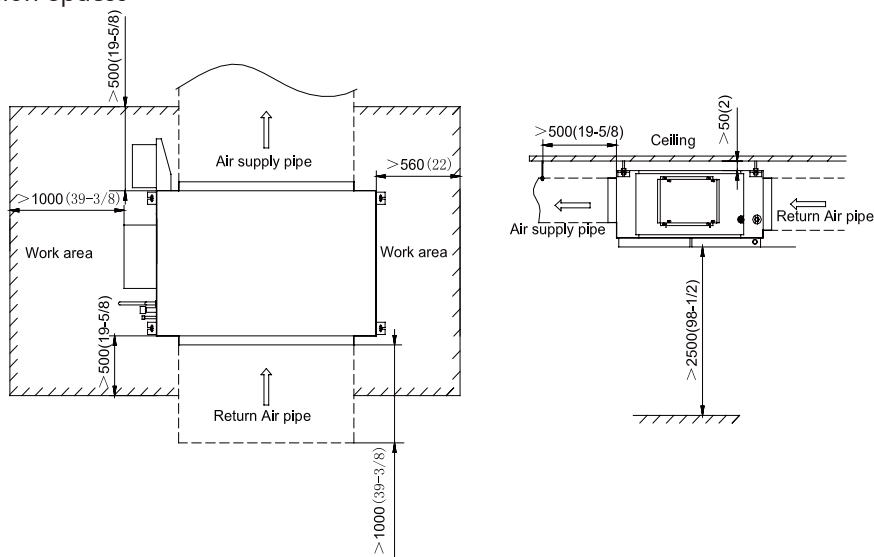

### NOTICE!

- ① Installation of the unit must be in accordance with National Electric Codes and local safety regulations.
- ② Improper installation will affect unit's performance, so do not install the unit by yourself. Please contact local dealer to arrange professional technicians for the installation.
- ③ Do not connect power until all installation work is finished.

## 7.2.6 Floor Ceiling Type

### (1) Outline and installation dimension

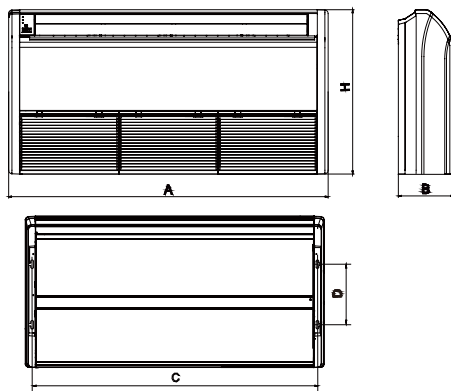

Below are dimensions of A, B, C, etc. for different models:

Unit: mm(in.)

Models:	A	B	C	D	H
GMV-ND09ZD/A-T(U) GMV-ND12ZD/A-T(U) GMV-ND18ZD/A-T(U)	1220 (48)	225 (8-7/8)	1158 (45-5/8)	280 (11)	700 (27-9/16)
GMV-ND24ZD/A-T(U) GMV-ND30ZD/A-T(U)	1420 (56)	245 (9-5/8)	1354 (53-5/16)	280 (11)	700 (27-9/16)
GMV-ND36ZD/A-T(U) GMV-ND42ZD/A-T(U) GMV-ND48ZD/A-T(U)	1700 (66-15/16)	245 (9-5/8)	1634 (64-5/16)	280 (11)	700 (27-9/16)

## (2) Installation Spaces

Floor type

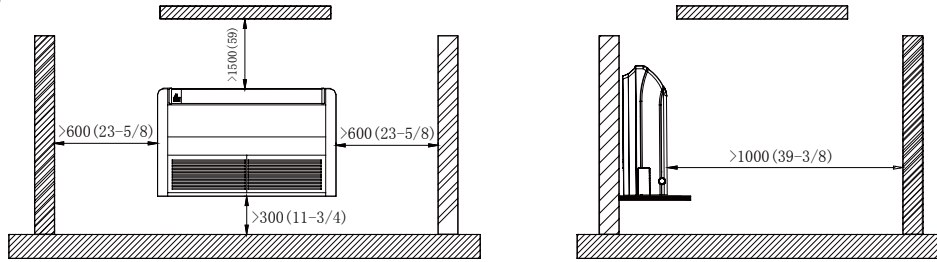

Ceiling type

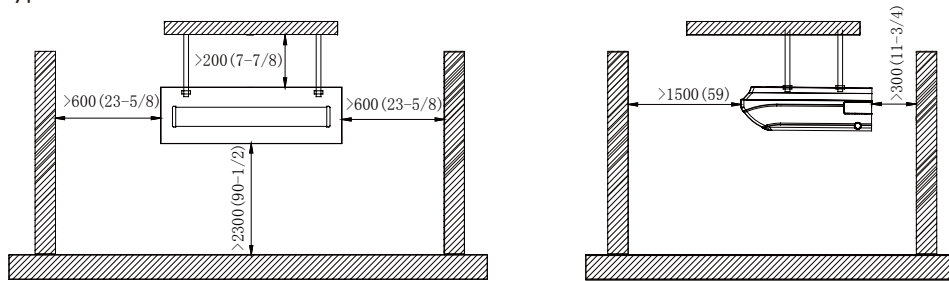

## 7.2.7 Wall-Mounted Type

External Dimensions

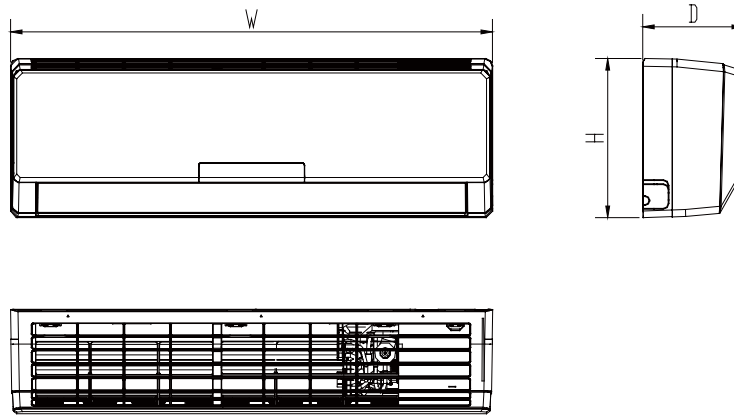

The table below lists the detailed dimensions.

Unit: mm(in.)

Model	W	H	D
GMV-N07G/A3A-D(U)	843	275	180
GMV-N09G/A3A-D(U)	(33-1/5)	(10-5/6)	(7)
GMV-N12G/A3A-D(U)	940	298	200
GMV-N18G/A3A-D(U)	(37)	(11-3/4)	(7-7/8)
GMV-N24G/A3A-D(U)	1008	319	221
	(39-2/3)	(12-5/9)	(8-5/7)
GMV-ND06G/B4B-T(U) GMV-ND07G/B4B-T(U)	845	289	209
GMV-ND09G/B4B-T(U) GMV-ND12G/B4B-T(U)	(33-1/4)	(11-3/8)	(8-1/4)
GMV-ND14G/B4B-T(U)	970	300	224
	(38-3/16)	(11-13/16)	(8-13/16)

# DC INVERTER MULTI VRF INDOOR UNIT TECHNICAL SALES GUIDE

Model	W	H	D
GMV-ND18G/B4B-T(U) GMV-ND24G/B4B-T(U)	1078 (42-7/16)	325 (12-13/16)	246 (9-11/16)
GMV-ND30G/B4B-T(U) GMV-ND36G/B4B-T(U)	1350 (53-1/8)	326 (12-13/16)	258 (10-3/16)

Installation Spaces

Unit: mm(in.)

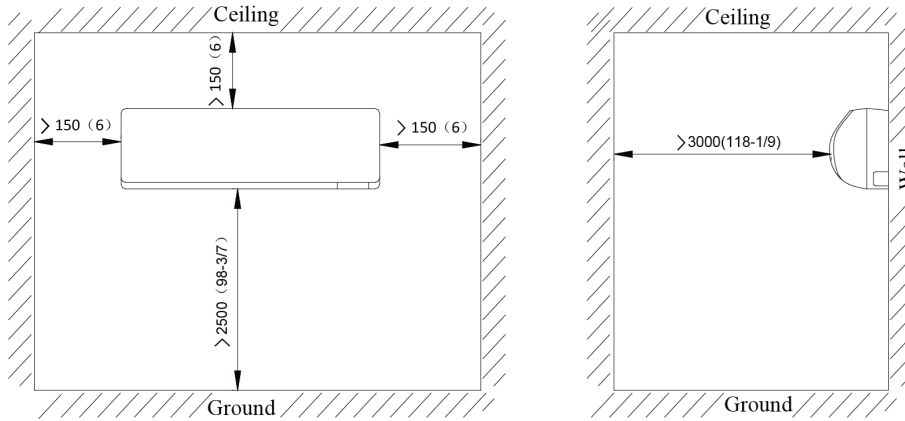

## 7.2.8 Console Type

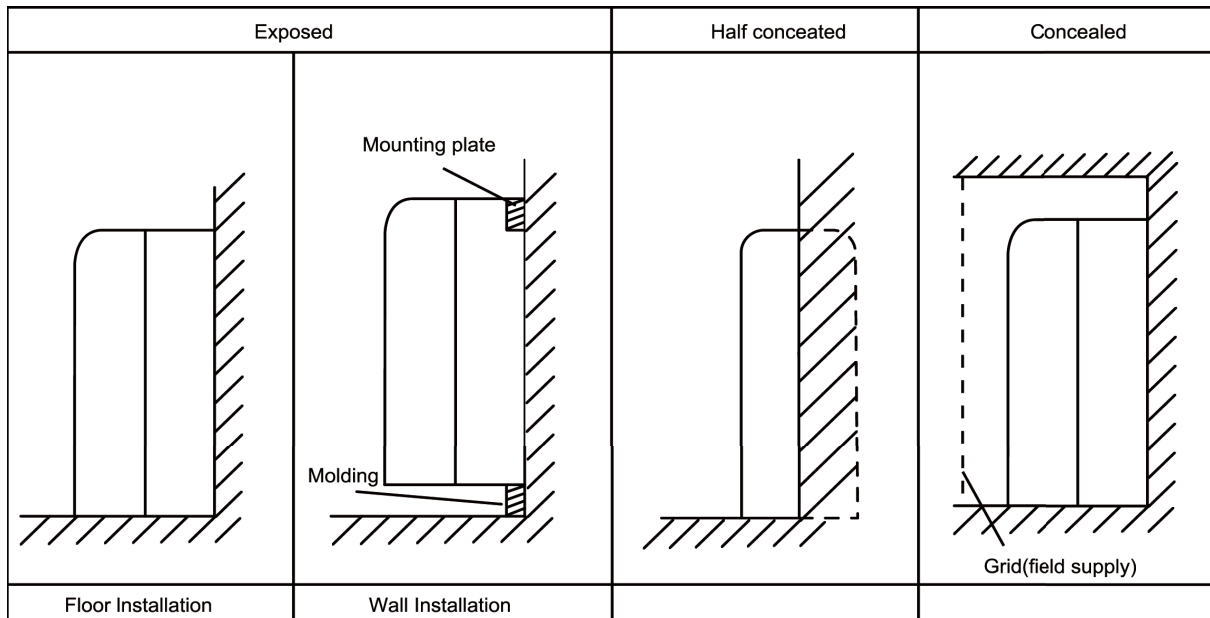

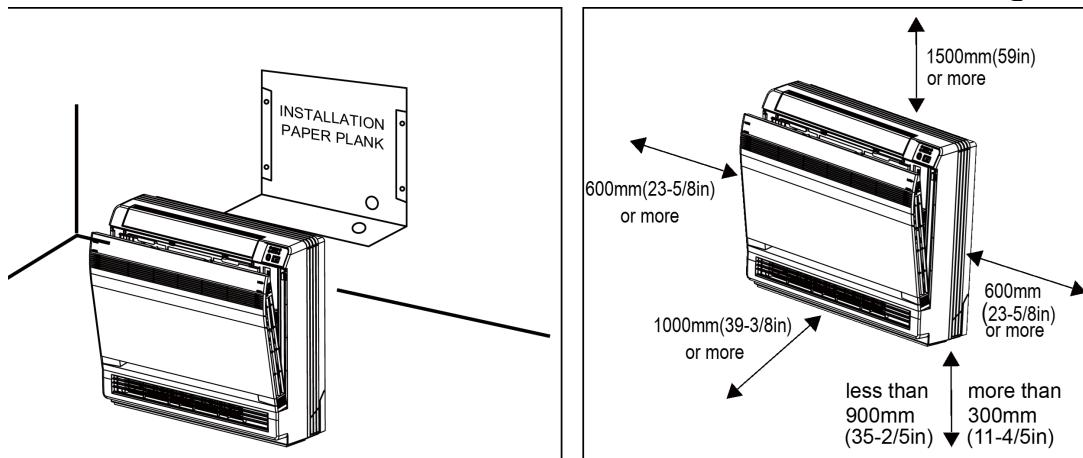
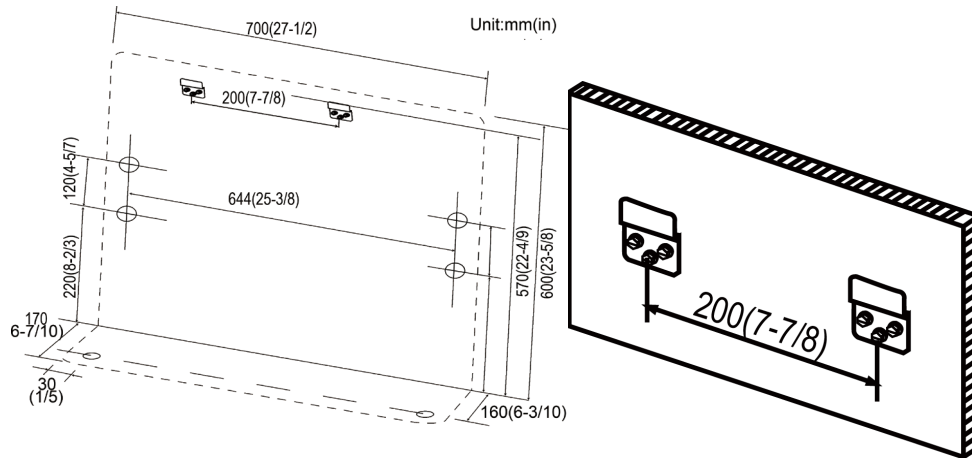

### 7.2.9 Two-way Cassette Type

Outline and installation dimension

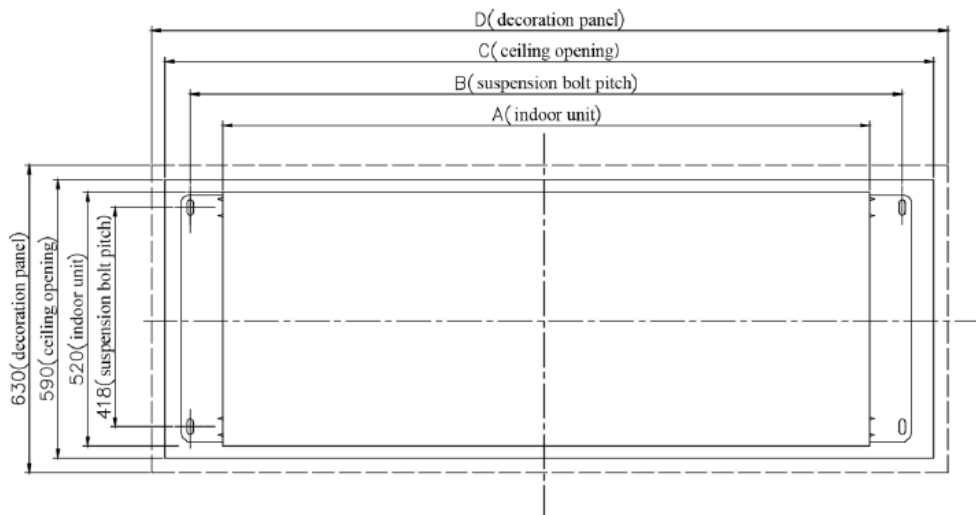

# DC INVERTER MULTI VRF INDOOR UNIT TECHNICAL SALES GUIDE

Unit: mm(in.)

Model	Indoor unit(A)	Suspension bolt pitch(B)	Ceiling opening(C)	Decoration panel(D)
GMV-ND09TS/A-T(U)	1200(47-1/4)	1252(49-5/16)	1403(55-1/4)	1443(56-13/16)
GMV-ND12TS/A-T(U) GMV-ND15TS/A-T(U)	1200(47-1/4)	1252(49-5/16)	1403(55-1/4)	1443(56-13/16)
GMV-ND18TS/A-T(U) GMV-ND24TS/A-T(U)	1200(47-1/4)	1252(49-5/16)	1403(55-1/4)	1443(56-13/16)

Installation space

Unit: mm(in.)

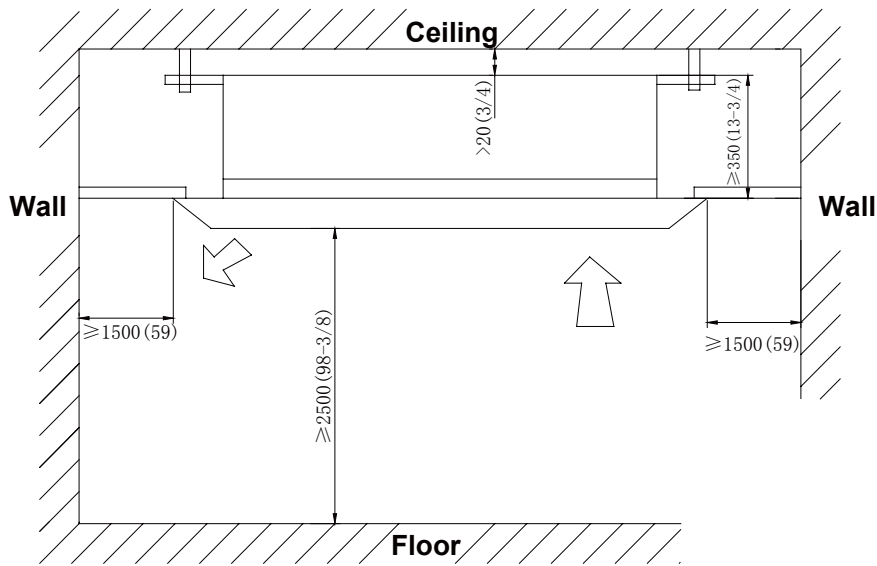

## 7.2.10 Compact Four-way Cassette Type Indoor Unit

Outline and installation dimension

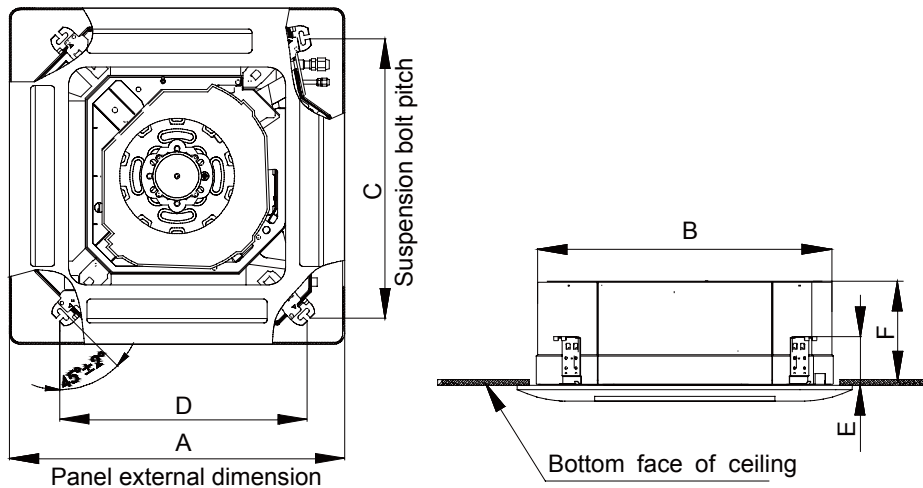





# DC INVERTER MULTI VRF INDOOR UNIT TECHNICAL SALES GUIDE

Model	A	B	C	D	E	F	G
GMV-ND12~24PHS/B-T(U)	1040 (40-15/16)	500 (19-11/16)	1130 (44-31/64)	300 (11-13/16)	754 (29-11/16)	1000 (39-3/8)	700 (27-9/16)
GMV-ND30~42PHS/B-T(U)	1440 (56-11/16)	500 (19-11/16)	1530 (60-1/4)	300 (11-13/16)	754 (29-11/16)	1400 (55-1/8)	700 (27-9/16)
GMV-ND48~54PHS/B-T(U)	1440 (56-11/16)	500 (19-11/16)	1580 (62-7/32)	300 (11-13/16)	754 (29-11/16)	1400 (55-1/8)	700 (27-9/16)

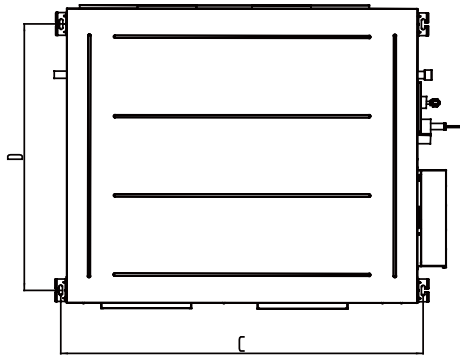
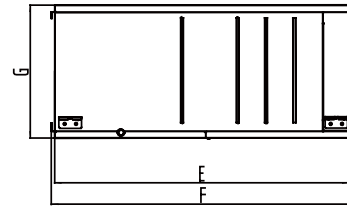
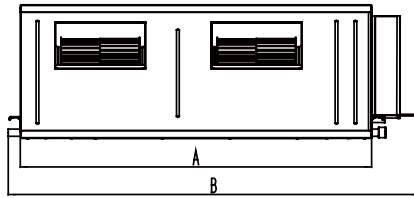

Below are dimensions of A, B, C, etc. for different models:

Unit:mm(in.)

Model	A	B	C	D	E	F	G
GMV-ND72~96PH/B-T(U)	1240 (48-3/4)	1452 (57-1/8)	1280 (50-3/8)	940 (38)	1040 (41)	1071 (42-1/8)	470 (18-1/2)

Installation Spaces

Unit: mm(in.)

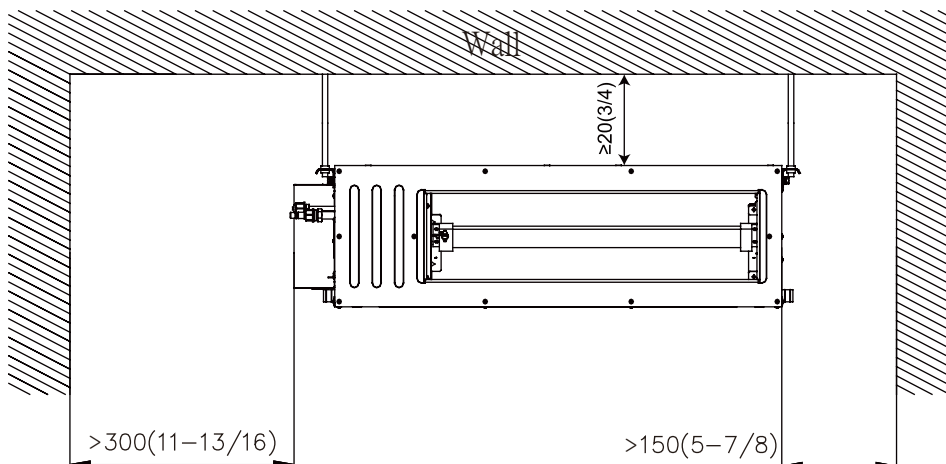

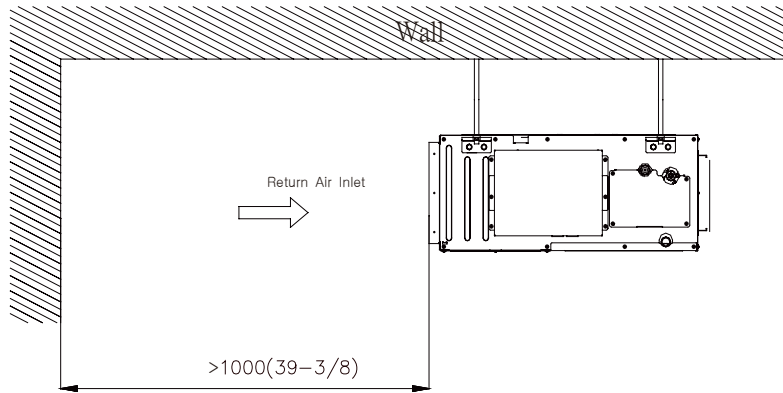

GMV-ND72~96PH/B-T(U)

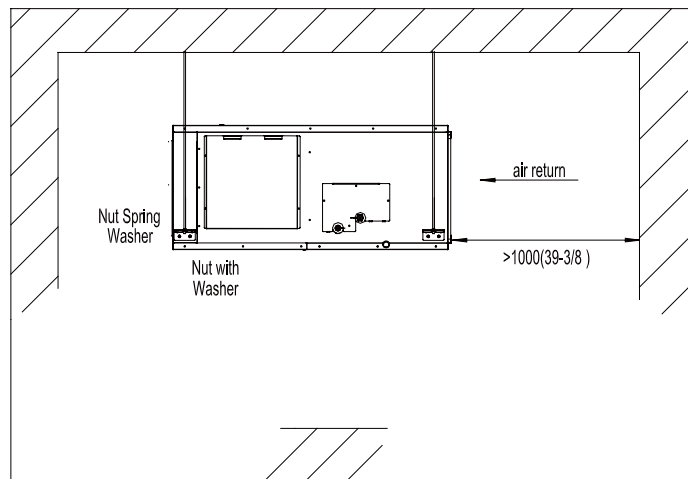
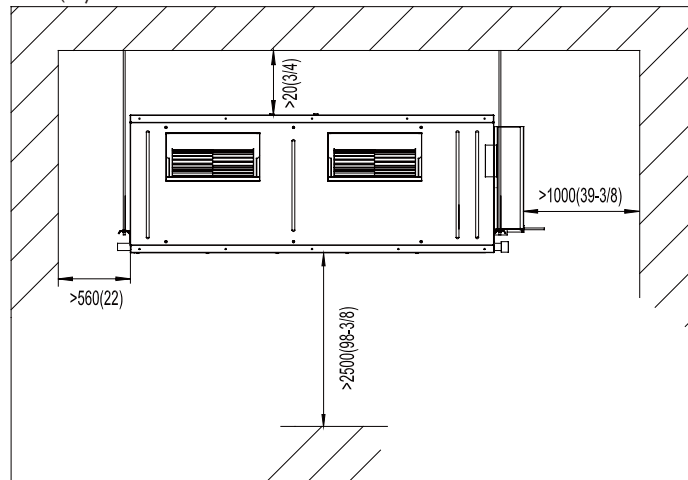

## 7.2.12 Air Handler Type Indoor Unit

### 7.2.12.1 Outline and installation dimension

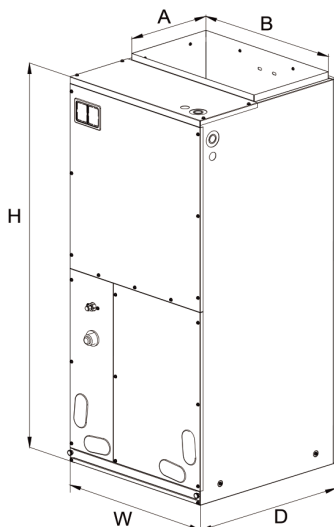

Below are dimensions of A, B, C, etc. for different models:

Unit: mm(in.)

Models:	DIMENSION				
	W	D	H	A	B
GMV-ND09A/A-T(U)	460 (18-1/8)	540 (21-1/4)	1105 (43-1/2)	295 (11-5/8)	426 (16-3/4)
GMV-ND12A/A-T(U)	460 (18-1/8)	540 (21-1/4)	1105 (43-1/2)	295 (11-5/8)	426 (16-3/4)
GMV-ND18A/A-T(U)	460 (18-1/8)	540 (21-1/4)	1105 (43-1/2)	295 (11-5/8)	426 (16-3/4)
GMV-ND24A/A-T(U)	460 (18-1/8)	540 (21-1/4)	1105 (43-1/2)	295 (11-5/8)	426 (16-3/4)
GMV-ND30A/A-T(U)	460 (18-1/8)	540 (21-1/4)	1105 (43-1/2)	295 (11-5/8)	426 (16-3/4)
GMV-ND36A/A-T(U)	540 (21-1/4)	540 (21-1/4)	1224 (48-1/4)	295 (11-5/8)	508 (20)
GMV-ND42A/A-T(U)	540 (21-1/4)	540 (21-1/4)	1224 (48-1/4)	295 (11-5/8)	508 (20)
GMV-ND48A/A-T(U)	630 (24-7/8)	540 (21-1/4)	1224 (48-1/4)	295 (11-5/8)	508 (20)
GMV-ND54A/A-T(U)	630 (24-7/8)	540 (21-1/4)	1224 (48-1/4)	295 (11-5/8)	508 (20)

### 7.2.12.2 Installation notice

When installing the air handler, take consideration to minimize the length of refrigerant tubing as much as possible. Do not install the air handler in a location either above or below the condenser that violates the instructions provided with the condenser. Service clearance is to take precedence. Allow a minimum of 24" in front of the unit for service clearance. When installing in an area directly over a finished ceiling (such as an attic), an emergency drain pan is required directly under the unit. See local and state codes for requirements. When installing this unit in an area that may become wet, elevate the unit with a sturdy, non-porous material. In installations that may lead to physical damage (i.e. a garage) it is advised to install a protective barrier to prevent such damage.

This air handler is designed for a complete supply and return ductwork system. Do not operate this product without all ductwork attached.

Based upon the actual conditions, if air handler is installed as type (A), the air handler should be concealed in a specific room or space and make sure the air handler is not accessible to the general public.

Based upon the actual conditions, if air handler is installed as type (B), make sure that there is enough

space for care and maintenance and the height between the air handler and ground is above 2500mm. And the air handler is not accessible to the general public.

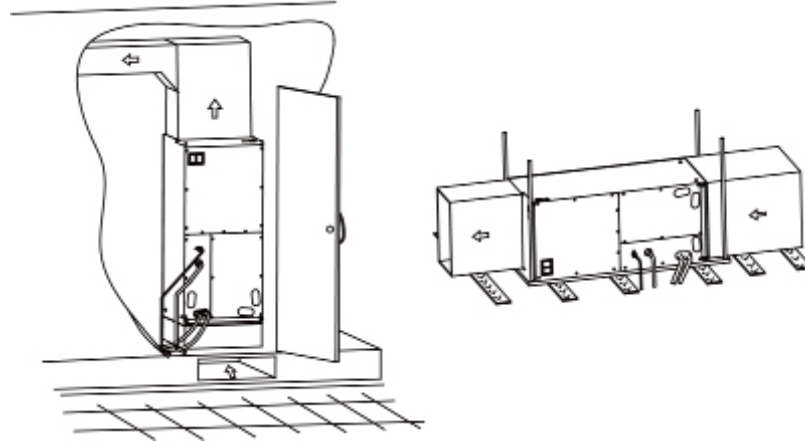

### 7.2.13 AHU-KIT Type Indoor Unit

Size of control box for GMV-N12U/A-T(U), GMV-N24U/A-T(U), GMV-N48U/A-T(U), GMV-N96U/A-T(U) and GMV-N192U/A-T(U) (Unit: mm(in.)):

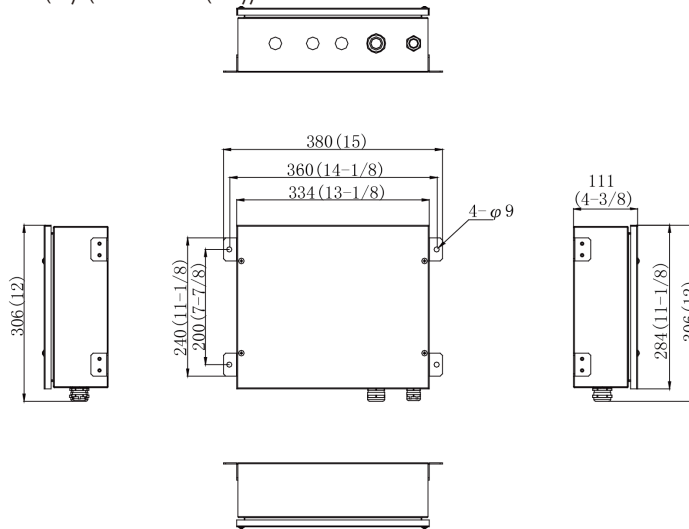

Size of EXV box for GMV-N12U/A-T(U), GMV-N24U/A-T(U), GMV-N48U/A-T(U), GMV-N96U/A-T(U) (Unit: mm(in.)):

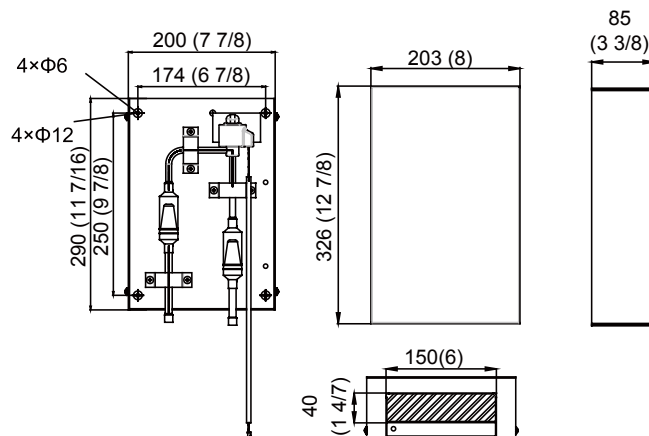

Size of EXV box for GMV-N192U/A-T(U) (Unit: mm(in.)):

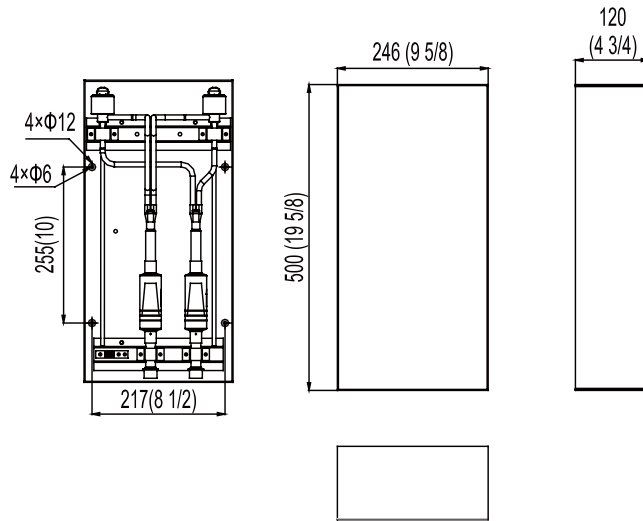

Maintenance space of control space (Unit: mm(in.)):

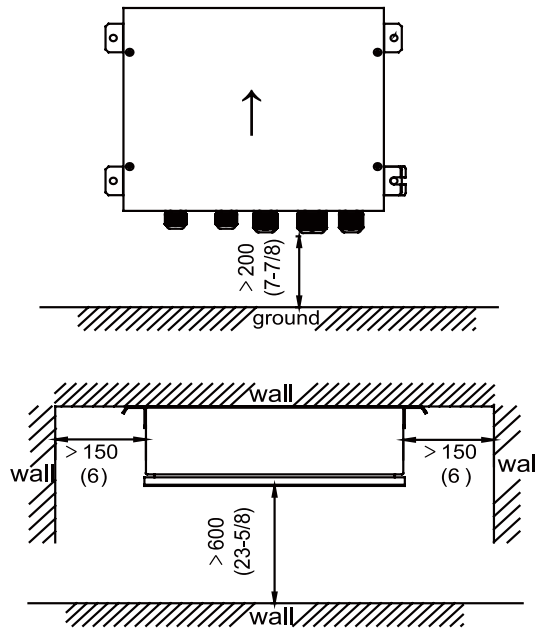

The control box must be installed upwards as the direction of the arrow shown in the figure

Maintenance space of EXV box (Unit: mm(in.):)

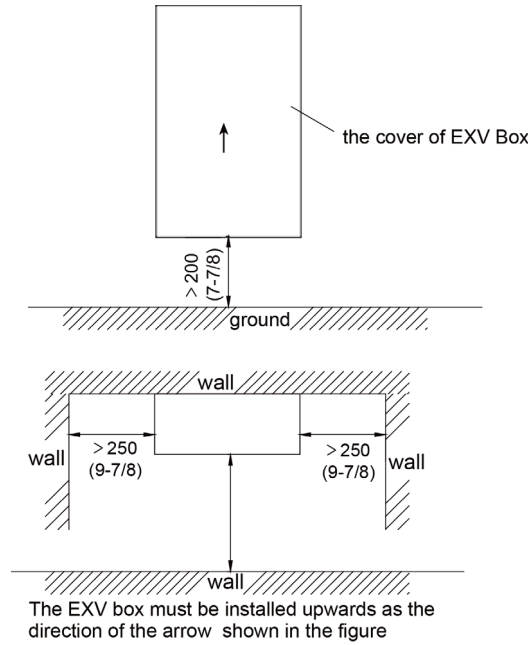

### 7.2.14 One-way Cassette Type

Outline and installation dimension

Unit: mm(in.)

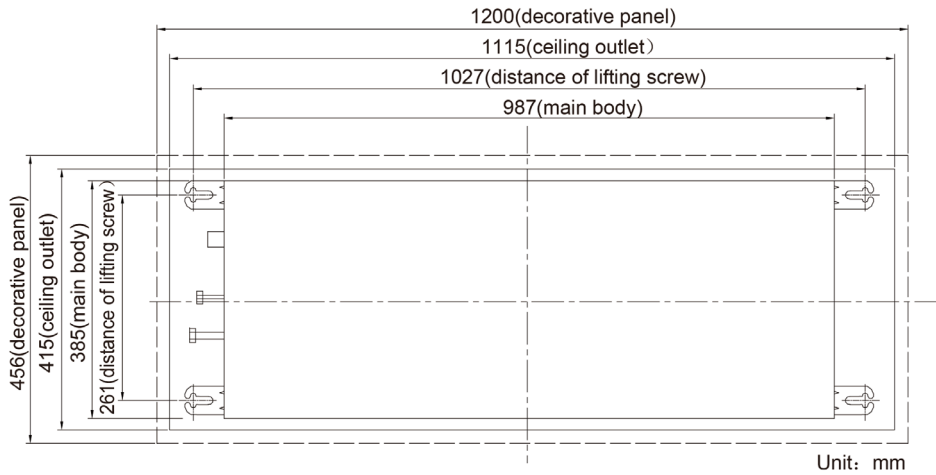

Model	Indoor unit(A)	Suspension bolt pitch(B)	Ceiling opening(C)	Decoration panel(D)
GMV-ND07TD/A-T(U)	987(38-7/8)	1027(40-3/8)	1115(43-7/8)	1200(47-1/4)
GMV-ND09TD/A-T(U)	987(38-7/8)	1027(40-3/8)	1115(43-7/8)	1200(47-1/4)
GMV-ND12TD/A-T(U)	987(38-7/8)	1027(40-3/8)	1115(43-7/8)	1200(47-1/4)

## Installation space

Unit: mm(in.)

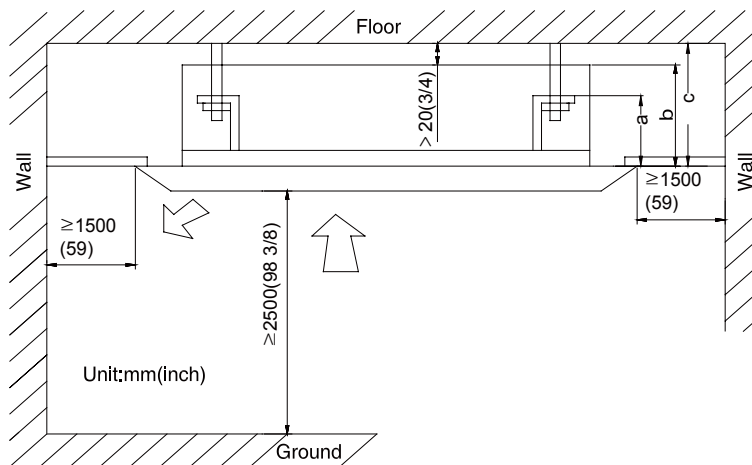

Model	a	b	c
07	141 (5 1/2)	207 (8 1/8)	227 (8 7/8)
09	141 (5 1/2)	207 (8 1/8)	227 (8 7/8)
12	141 (5 1/2)	207 (8 1/8)	227 (8 7/8)

## 7.2.15 Low ESP Duct Type Series

Outline and installation dimension

The following diagram is applicable for units with the cooling capacity ranging from 30k Btu/h to 48k Btu/h.

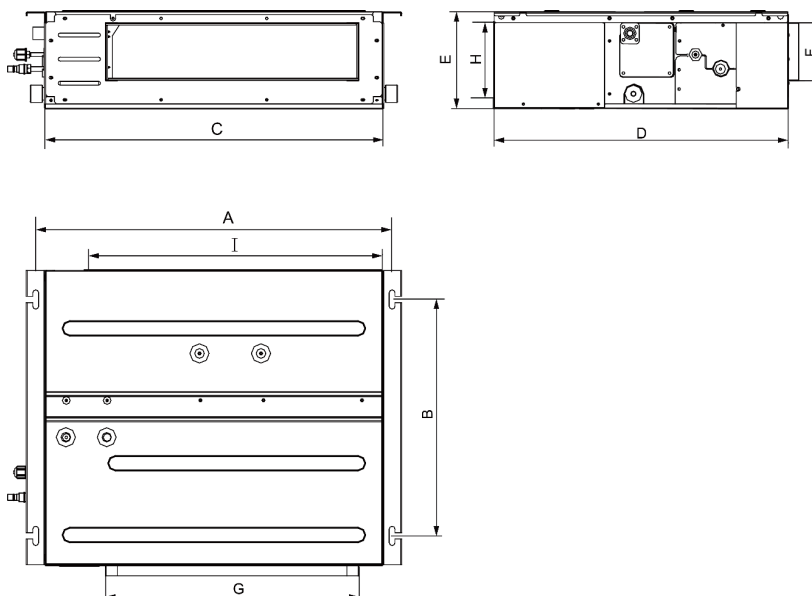

The following table lists the detailed dimensions.

Unit: mm(inch)

Model	Item	A	B	C	D	E	F	G	H	I
GMV-ND30PLS/C-T(U)										
GMV-ND36PLS/C-T(U)		1379	565	1340	655	260	207	1153	220	1188
GMV-ND42PLS/C-T(U)		(54-5/16)	(22-1/4)	(52-3/4)	(25-13/16)	(10-1/4)	(8-1/8)	(45-3/8)	(8-11/16)	(46-3/4)
GMV-ND48PLS/C-T(U)										

Installation space

Unit: mm(inch)

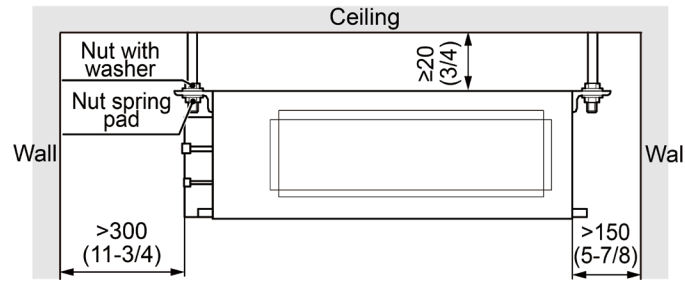

### 7.2.16 360° Air Discharge Compact Cassette Type

Outline and Installation Dimension

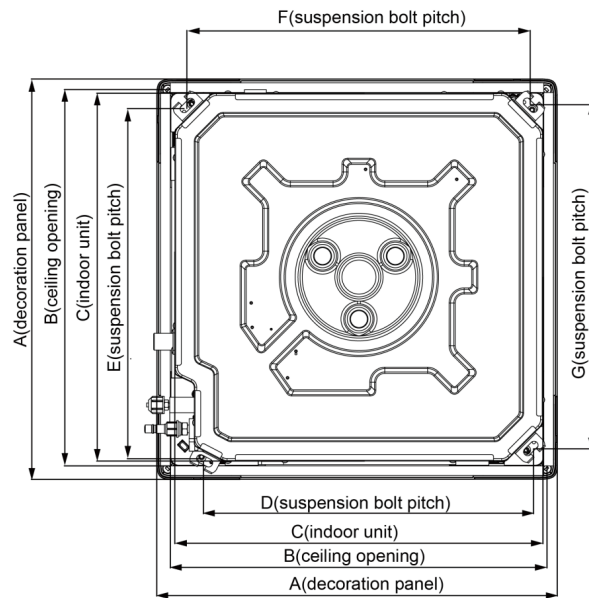

Unit: mm(inch)

Model	A	B	C	D	E	F	G
GMV-ND05T/E-T(U)							
GMV-ND07T/E-T(U)							
GMV-ND09T/E-T(U)	620	580	570	505	550	530	530
GMV-ND12T/E-T(U)	(24-3/8)	(22-13/16)	(22-7/16)	(19-7/8)	(22-5/8)	(20-7/8)	(20-7/8)
GMV-ND15T/E-T(U)							
GMV-ND18T/E-T(U)							

Unit: mm(inch)

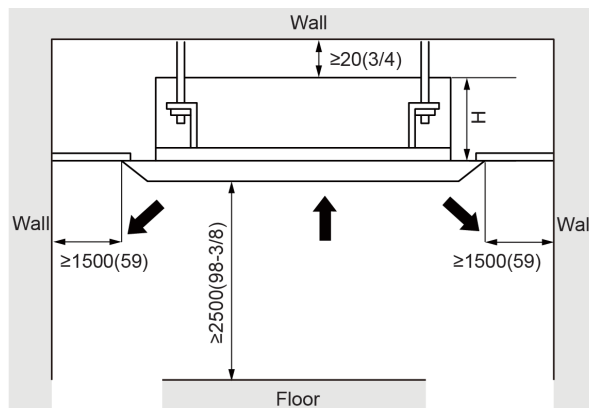



# DC INVERTER MULTI VRF INDOOR UNIT TECHNICAL SALES GUIDE

Unit: mm(inch)

Model	H
GMV-ND05~18T/E-T(U)	305(12)

## 7.2.17 360°Air Discharge Cassette Type

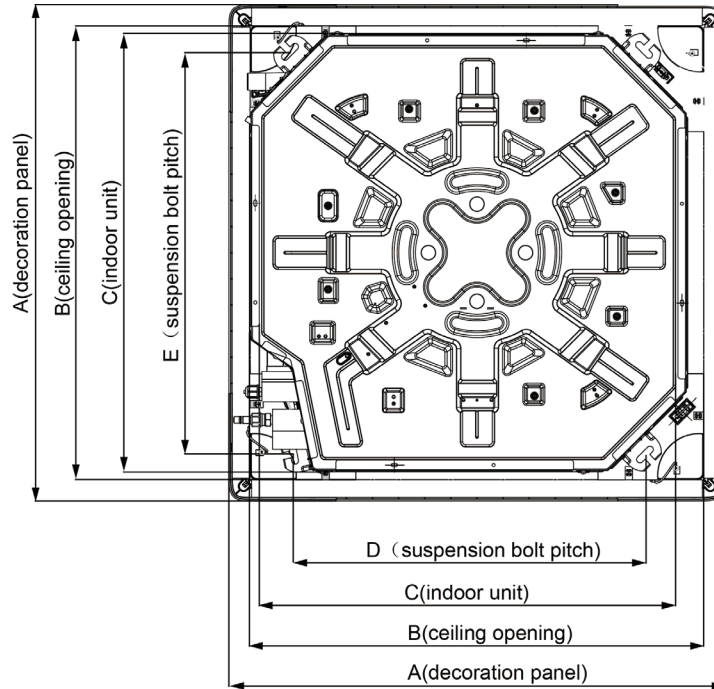

Unit: mm(inch)

Model	A	B	C	D	E
GMV-ND07~48T/C-T(U)	950(37 3/8)	890(35)	840(33 1/8)	680(26 3/4)	780(30 3/4)

Unit: mm(inch)

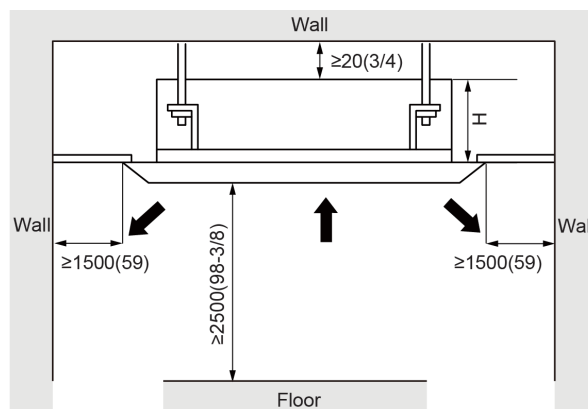

Unit: mm(inch)

Model	H
GMV-ND07~24T/C-T(U)	280(11)
GMV-ND30~48T/C-T(U)	330(13)

### 7.3 Locating The Manhole And Air Return Vent

In addition to consideration of the sufficient maintenance space to be reserved during unit locating, it is also important to locate the manhole. If manhole locating is improper, it will also make future maintenance and repair more difficult.

The manhole size can accommodate the shoulder width of a normal adult. It cannot be smaller than 450 mm × 450 mm. Usually the indoor unit in the air supply mode of air duct is located at the electric box side of the unit, the distance from the electric box is 50 mm to 100 mm, and maintenance of the pipeline part must also be considered. The pipeline maintenance position of the pipeline is mainly considered for the air raise type indoor unit, so the manhole can be located at a position that ensures the distance between one edge and the connection pipe is 200 mm to 250 mm. The schematic diagram is shown below:

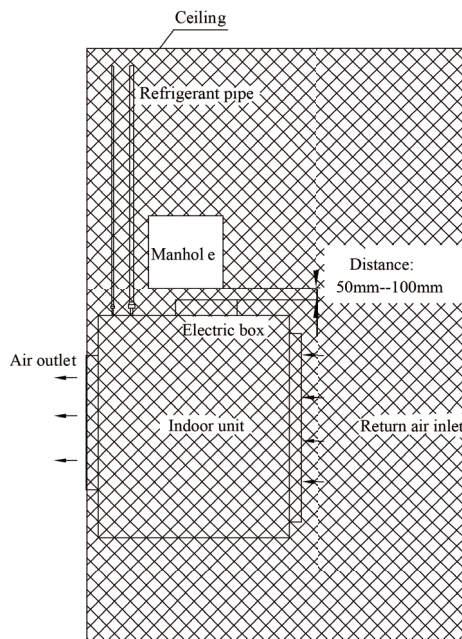

The air return vent position must also be considered for the indoor unit in the air supply mode of air duct. The air return vent is responsible for air return of the unit, and also used to complete maintenance of the indoor fan motor and filter screen. Therefore, in addition to meeting the air return design requirements mentioned above, there is a must to ensure the requirement for replacing the motor and filter screen.

- (1) Do not set the air return vent of the unit near the door, toilet or kitchen; otherwise problems such as condensation and peculiar smell may be caused.
- (2) The length direction of the air return vent cannot be smaller than 2/3 of the air return vent length of the unit.
- (3) If the air return vent is set directly behind the unit, the distance between its position and the unit cannot be greater than 300 mm.

The width direction of the air return vent cannot be smaller than 200 mm.

(4) For the design of also using the air return vent as a manhole for the electric box, the maintenance position should also be reserved at the electric box side according to the above principle. At the same time, it is required to consider whether the position of the air return vent can ensure easy removal and replacement of the fan motor and filter screen. Therefore, the air return vent should be enlarged to 1.5 to 2 times of the original circulation area according to the actual conditions and on the basis of satisfying the air volume design. The schematic diagram is shown below:

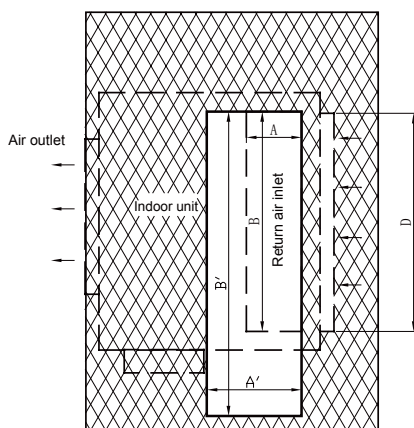

Original air return vent area:  $S = A \times B$   
 Currently air return vent area:  $S' = A' \times B'$   
 $S' \geq (1.5 \sim 2.0)S$

## 8 REQUIREMENTS FOR COMMUNICATION MODE

### 8.1 Communication Connection Mode Between The Indoor Unit And Wired Controller

The indoor unit and the wired controller are connected in one of the following four modes, which are respectively shown in Figure below:

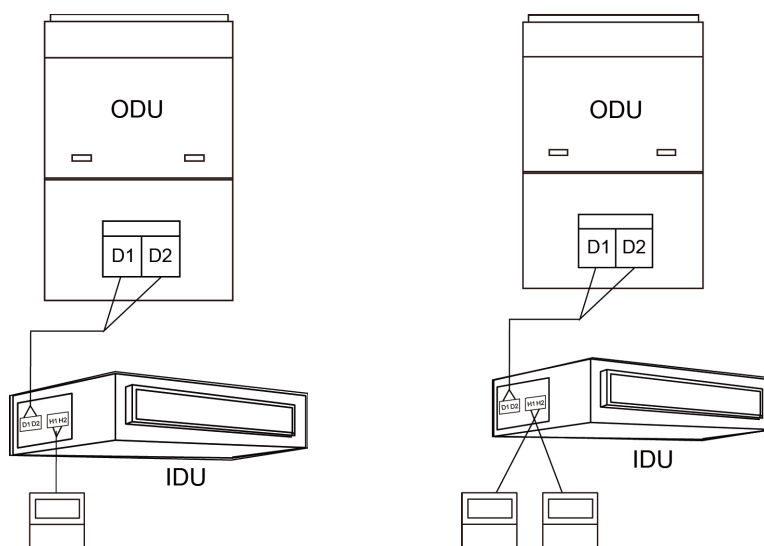

One wire controller controls one indoor unit

Two wire controllers control one indoor unit

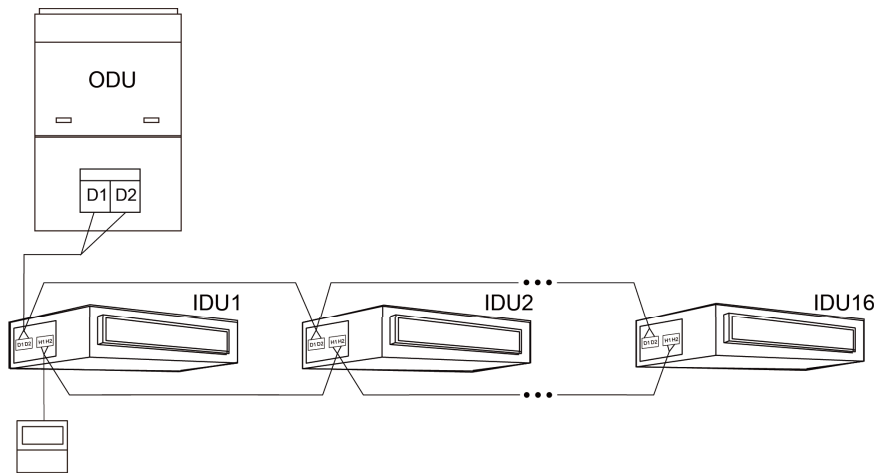

One wire controller controls multiple indoor units

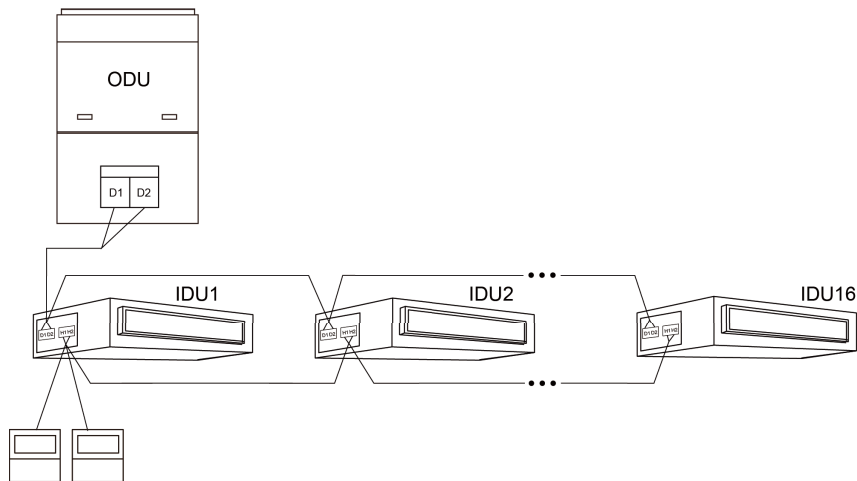

Two wire controllers control multiple indoor units

**Note:**

Multi variable air conditioners floor standing type indoor unit only applicable One wire controller controls one indoor unit.

When two wired controllers control multiple indoor units at the same time, the wired controller can be connected to any indoor unit, the connected indoor units must belong to the same series, and only one wired controller must be set to a slave wired controller. The number of indoor units controlled by the wired controllers is not more than 16, and the connected indoor units must be on the same indoor unit network.

The slave wired controller can be set in the power-on or power-off status:

- (1) Press and hold the "FUNCTION" button on the wired controller to be set to a slave wired controller for five seconds. The temperature area displays "C00". Continue holding the "FUNCTION" button for five seconds to enter the wired controller parameter setting interface. The temperature area displays "P00" by default.
- (2) Select a P13 parameter code by pressing "▲" or "▼". Press the "MODE" button to switch to parameter value settings. The parameter value blinks. Press "▲" or "▼" to select "02", and then press the "ENTER/CANCEL" button to complete settings.
- (3) Press the "ENTER/CANCEL" button to return to the upper-level menu till quitting parameter settings. The user parameter setting list is as follows:

Parameter Code	Parameter Name	Parameter Range	Default Value	Remarks
P13	Wired controller address settings	01: master wired controller 02: slave wired controller	01	When two wired controllers simultaneously control one or more indoor units, the two wired controllers must use different addresses. The slave wired controller (address: 02) does not have the unit parameter setting function except its own address settings.

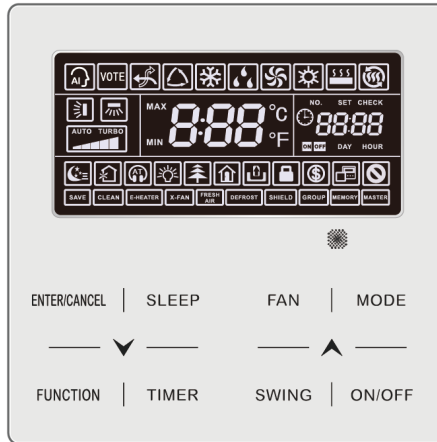

**Notice!**

- ① The default factory setting of all the wired controllers is the master wired controller status.
- ② In the parameter setting status, the "FAN", "Timer", "SLEEP", and "SWING" buttons are invalid. By pressing "ON/OFF", you can return to the main interface but will not power on/off the unit.
- ③ In the parameter setting status, signals of the remote controller are invalid.

## 8.2 Connection Mode Between The Duct Type Indoor Unit And Receiving LED Panel

When the air duct-type indoor unit needs to be connected to a remote receiving LED panel, they are connected through DISP1 and DISP2 of the main board for indoor unit:

Indoor Unit Type	Model of Remote Receiving LED Panel	Connection Wire Type	Main Board Interface of Corresponding Indoor Unit
Air duct-type indoor unit	JS05	Inter-board connecting line (17 cores)	DISP1 (interconnected to the 8-core interface) DISP2 (interconnected to the 9-core interface)

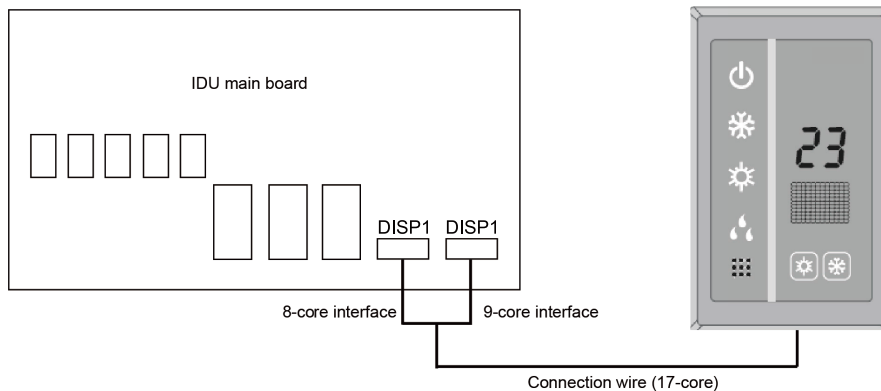

**Notice!**

- ① The wired controller and remote receiving LED panel can be used at the same time.
- ② Note to select a remote controller when a remote receiving LED panel is used.

## 9 OPTIONAL COMPONENTS

Wired controller	XK46, XK79, XE70-33/H	For the Cassette, Wall Mounted, Console, Floor Ceiling, AHU-KIT type units
Remote controller	YAP1F	For the Duct type units
Remote receiving LED panel	JS05	Applicable to the Duct type indoor unit
Remote controller for debugging	YV1L1	With the debugging function, used to set functions of the indoor unit

