



Service Manual

4LIV30HP230V1A

4LIV36HP230V1A

GREE ELECTRIC APPLIANCES, INC. OF ZHUHAI



Table of Contents

Part I : Technical Information	1
1. Summary	1
2. Specifications	2
2.1 Specification Sheet.....	2
2.2 Capacity Variation Ratio According to Temperature	8
2.3 Cooling and Heating Data Sheet in Rated Frequency	9
3. Outline Dimension Diagram	10
3.1 Indoor Unit.....	10
3.2 Outdoor Unit.....	11
4. Refrigerant System Diagram	12
4. Refrigerant System Diagram	13
5. Electrical Part	14
5.1 Wiring Diagram.....	14
5.2 PCB Printed Diagram.....	17
6. Function and Control	19
6.1 Remote Controller Introduction.....	19
6.2 GREE+ App Operation Manual.....	28
6.3 Ewpe Smart App Operation Manual	29
6.4 Brief Description of Modes and Functions.....	30
Part II : Installation and Maintenance	33
7. Notes for Installation and Maintenance	33
8. Installation	36
8.1 Installation Dimension Diagram	36
8.2 Installation Parts-checking	38
8.3 Selection of Installation Location.....	38
8.4 Electric Connection Requirement	38
8.5 Installation of Indoor Unit.....	38

2. Specifications

2.1 Specification Sheet

INTENTIONALLY BLANK

2. Specifications

Outdoor Unit	Outdoor Unit Model		4LIV30HP230V1AO	
	Outdoor Unit Product Code		CB432W29200	
	Compressor Manufacturer		ZHUHAI LANDA COMPRESSOR CO.,LTD	
	Compressor Model		QXFS-B238zX070	
	Compressor Oil		RB68DA or equivalent	
	Compressor Type		Rotary	
	Compressor LRA.	A		27
	Compressor RLA	A		14.2
	Compressor Power Input	W		2020
	Compressor Overload Protector			/
	Throttling Method			Electron expansion valve
	Set Temperature Range	°F		61~86
	Cooling Operation Ambient Temperature Range	°F		-4~122
	Heating Operation Ambient Temperature Range	°F		-13~75
	Condenser Form			Aluminum Fin-copper Tube
	Condenser Pipe Diameter	mm		Φ7
	Condenser Rows-fin Gap	mm		2-1.4
	Condenser Coil Length (LXDXW)	mm		955X38.1X704
	Fan Motor Speed	rpm		850
	Fan Motor Power Output	W		90
	Fan Motor RLA	A		0.9
	Fan Motor Capacitor	μF		/
	Outdoor Unit Air Flow Volume	CFM		2648
	Fan Type			Axial-flow
	Fan Diameter	mm		Φ570
	Defrosting Method			Automatic Defrosting
	Climate Type			T1
	Isolation			I
	Moisture Protection			IPX4
	Permissible Excessive Operating Pressure for the Discharge Side	MPa		4.3
	Permissible Excessive Operating Pressure for the Suction Side	MPa		2.5
	Sound Pressure Level (H/M/L)	dB (A)		62/-/-
	Sound Power Level (H/M/L)	dB (A)		72/-/-
Dimension(WXHXD)	inch		39 3/8 × 29 3/8 × 16 13/16	
Dimension of Carton Box (LXWXH)	inch		42 26/64 X 18 57/64 X 30 58/64	
Dimension of Package(LXWXH)	inch		42 33/64 × 19 1/64 × 31 57/64	
Net Weight	lb		113.6	
Gross Weight	lb		124.6	
Refrigerant			R410A	
Refrigerant Charge	oz		74.1	
Connection Pipe	Connection Pipe Length	ft	24.6	
	Connection Pipe Gas Additional Charge	oz/ft	0.5	
	Outer Diameter Liquid Pipe	inch	1/4"	
	Outer Diameter Gas Pipe	inch	5/8"	
	Max Distance Height	ft	32.8	
	Max Distance Length	ft	82	
Note: The connection pipe applies metric diameter.				

The above data is subject to change without notice. Please refer to the nameplate of the unit.

INTENTIONALLY BLANK

INTENTIONALLY BLANK

INTENTIONALLY BLANK

2. Specifications

Outdoor Unit	Outdoor Unit Model		4LIV36HP230V1AO	
	Outdoor Unit Product Code		CB432W31000	
	Compressor Manufacturer		ZHUHAI LANDA COMPRESSOR CO., LTD.	
	Compressor Model		QXFS-D280zX070	
	Compressor Oil		FW68DA or equivalent	
	Compressor Type		Rotary	
	Compressor LRA.	A		40.00
	Compressor RLA	A		16.00
	Compressor Power Input	W		2294
	Compressor Overload Protector			/
	Throttling Method			Electron expansion valve
	Set Temperature Range	°F		61~86
	Cooling Operation Ambient Temperature Range	°F		-4~122
	Heating Operation Ambient Temperature Range	°F		-13~75
	Condenser Form			Aluminum Fin-copper Tube
	Condenser Pipe Diameter	mm		Φ7.94
	Condenser Rows-fin Gap	mm		2-1.4
	Condenser Coil Length (LXDXW)	mm		955X38.1X704
	Fan Motor Speed	rpm		850
	Fan Motor Power Output	W		90
	Fan Motor RLA	A		1.50
	Fan Motor Capacitor	μF		/
	Outdoor Unit Air Flow Volume	CFM		2648
	Fan Type			Axial-flow
	Fan Diameter	mm		Φ570
	Defrosting Method			Automatic Defrosting
	Climate Type			T1
	Isolation			I
	Moisture Protection			IPX4
	Permissible Excessive Operating Pressure for the Discharge Side	MPa		4.3
	Permissible Excessive Operating Pressure for the Suction Side	MPa		2.5
	Sound Pressure Level (H/M/L)	dB (A)		62/-/-
	Sound Power Level (H/M/L)	dB (A)		72/-/-
Dimension(WXHXD)	inch		39 3/8 × 29 3/8 × 16 13/16	
Dimension of Carton Box (LXWXH)	inch		42 26/64 X 18 57/64 X 30 58/64	
Dimension of Package(LXWXH)	inch		42 33/64 × 19 1/64 × 31 57/64	
Net Weight	lb		127.9	
Gross Weight	lb		138.9	
Refrigerant			R410A	
Refrigerant Charge	oz		84.7	
Connection Pipe	Connection Pipe Length	ft	24.6	
	Connection Pipe Gas Additional Charge	oz/ft	0.5	
	Outer Diameter Liquid Pipe	inch	1/4"	
	Outer Diameter Gas Pipe	inch	5/8"	
	Max Distance Height	ft	32.8	
	Max Distance Length	ft	82.0	
Note: The connection pipe applies metric diameter.				

The above data is subject to change without notice. Please refer to the nameplate of the unit.

2. Specifications

2.2 Capacity Variation Ratio According to Temperature

Cooling operation ambient temperature range is -4°F~122°F
 Heating operation ambient temperature range is -13°F~75°F

30K:

Cooling:

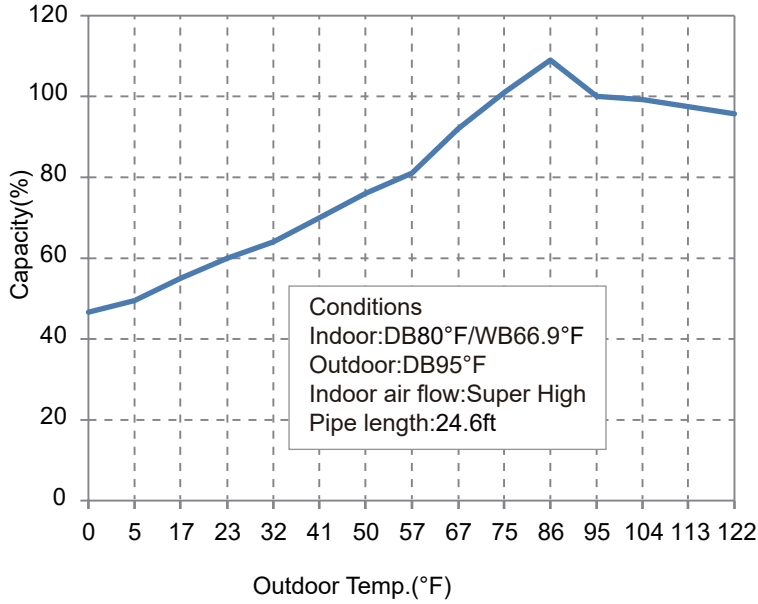

Heating:

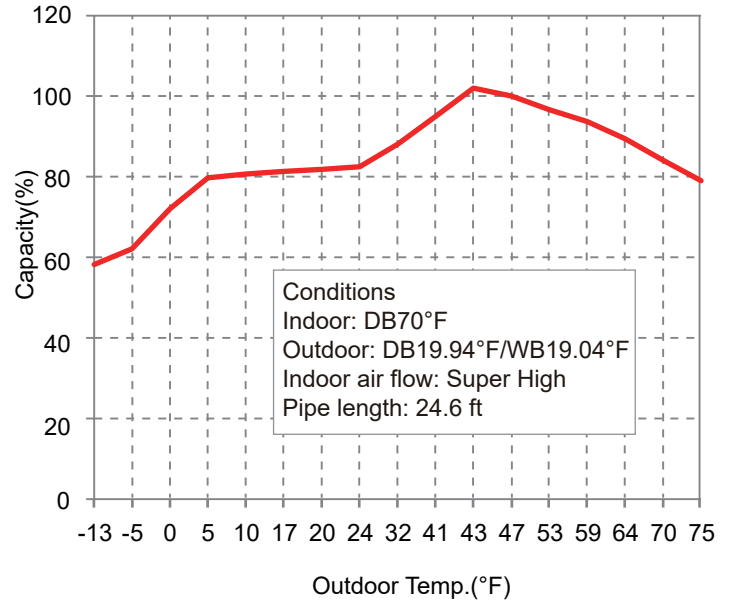

36K:

Cooling:

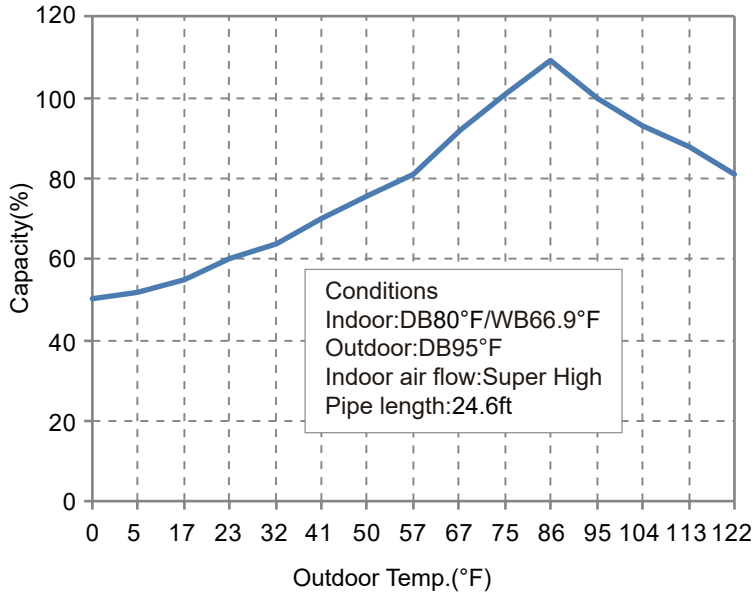

Heating:

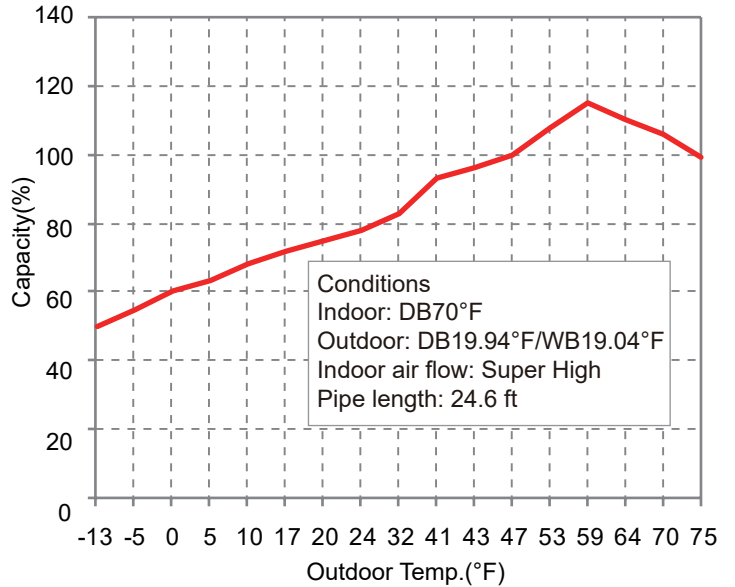

2. Specifications

Cooling operation ambient temperature range is 0°F~109°F
 Heating operation ambient temperature range is -31°F~75°F

Cooling:

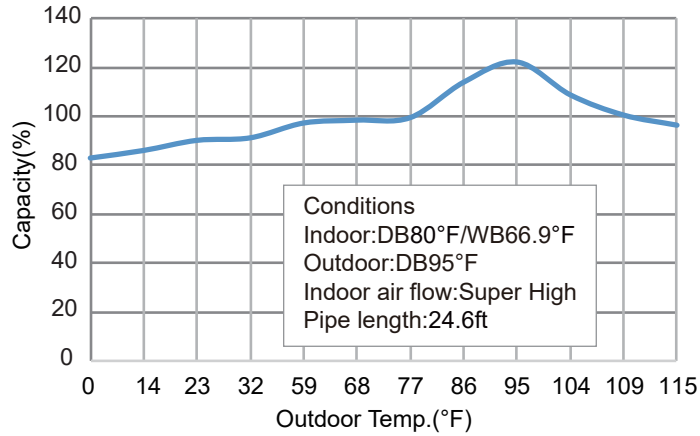

Heating:

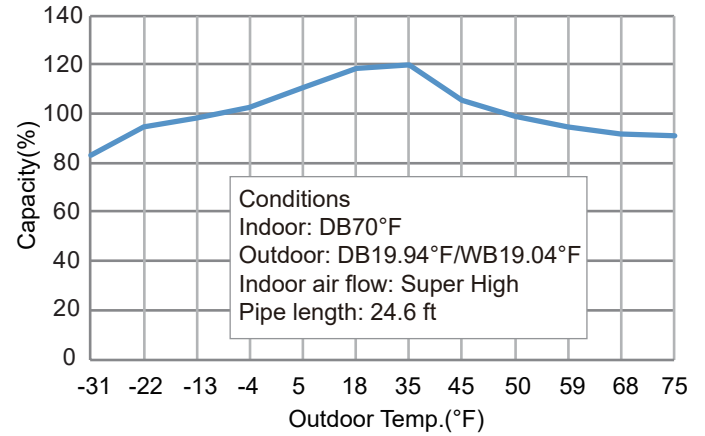

2.3 Cooling and Heating Data Sheet in Rated Frequency

Cooling:

Rated cooling condition(°F) (DB/WB)		Model	Pressure of gas pipe connecting indoor and outdoor unit	Inlet and outlet pipe temperature of heat exchanger		Fan speed of indoor unit	Fan speed of outdoor unit	Compressor revolution (rps)
Indoor	Outdoor			T1 (°F)	T2 (°F)			
80/66.9	95/-	30K	130~145	46.8 to 52.8	127 to 96.8	Super High	High	46
80/66.9	95/-	36K	130~145	46.8 to 52.8	127 to 96.8	Super High	High	37

Heating:

Rated heating condition(°F) (DB/WB)		Model	Pressure of gas pipe connecting indoor and outdoor unit	Inlet and outlet pipe temperature of heat exchanger		Fan speed of indoor unit	Fan speed of outdoor unit	Compressor revolution (rps)
Indoor	Outdoor			T1 (°F)	T2 (°F)			
70/-	19.94/19.04	30K	507~550	134.4 to 102	36 to 39	Super High	High	46
70/-	19.94/19.04	36K	507~550	134.4 to 102	36 to 39	Super High	High	34

Instruction:

T1: Inlet and outlet pipe temperature of evaporator

T2: Inlet and outlet pipe temperature of condenser

P: Pressure at the side of big valve

Connection pipe length: 24.6ft.

3. Outline Dimension Diagram

3.1 Indoor Unit

4LIV30HP230V1AH 4LIV36HP230V1AH

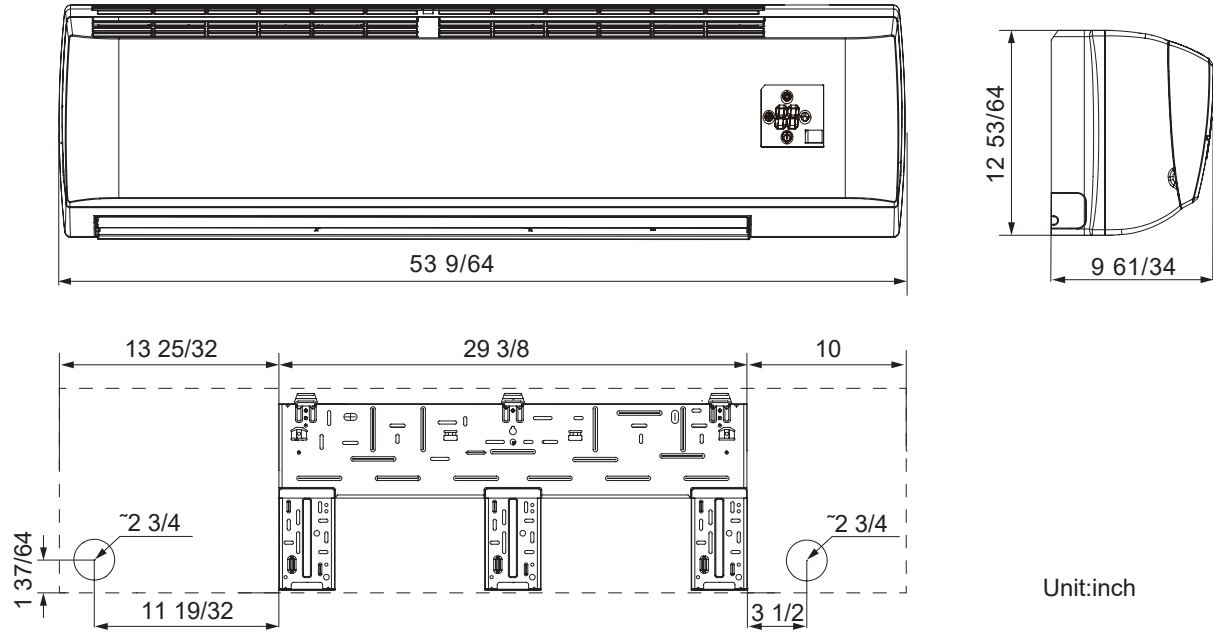

Unit:inch

4. Refrigerant System Diagram

4LIV30HP230V1A

4LIV36HP230V1A

Cooling and heating model

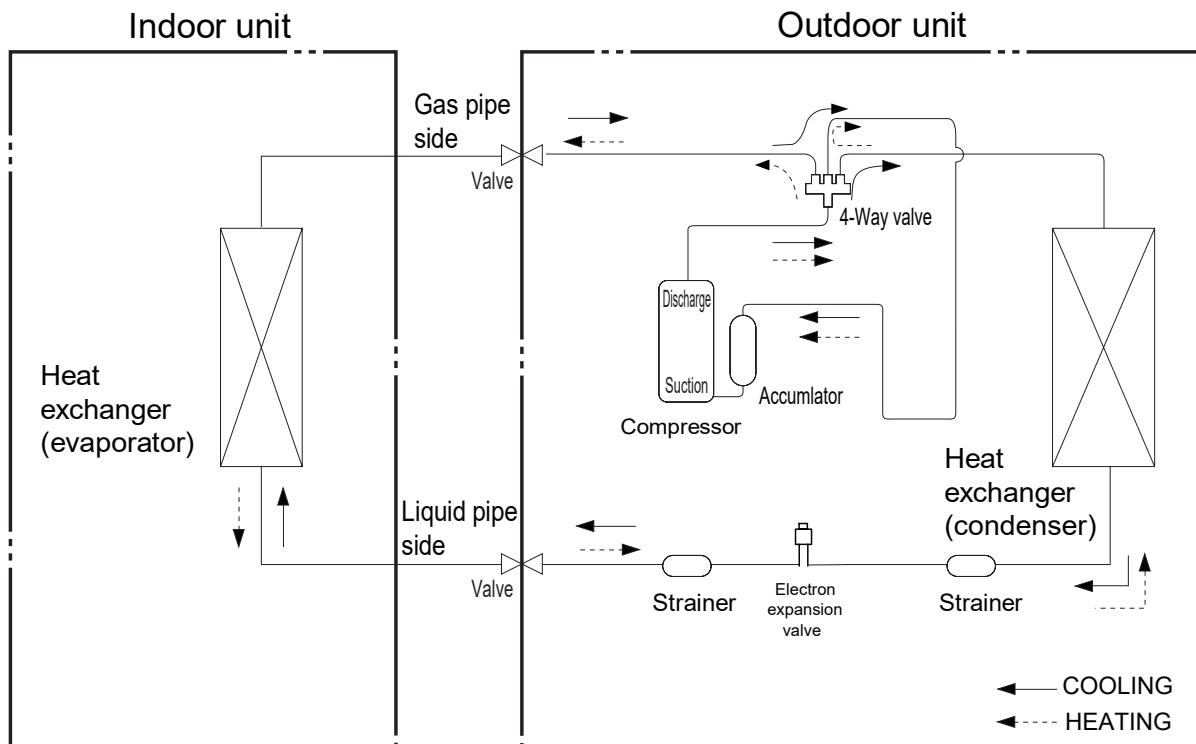

Connection pipe specification:

Liquid pipe: 1/4"

Gas pipe: 5/8"

INTENTIONALLY BLANK

5. Electrical Part

5.1 Wiring Diagram

• Instruction

Symbol	Symbol Color	Symbol	Symbol Color	Symbol	Name
WH	White	GN	Green	CAP	Jumper cap
YE	Yellow	BN	Brown	COMP	Compressor
RD	Red	BU	Blue		Grounding wire
YEGN	Yellow/Green	BK	Black	/	/
VT	Violet	OG	Orange	/	/

Note: Jumper cap is used to determine fan speed and the swing angle of horizontal lover for this model.

• Indoor Unit

4LIV30HP230V1AH

4LIV36HP230V1AH

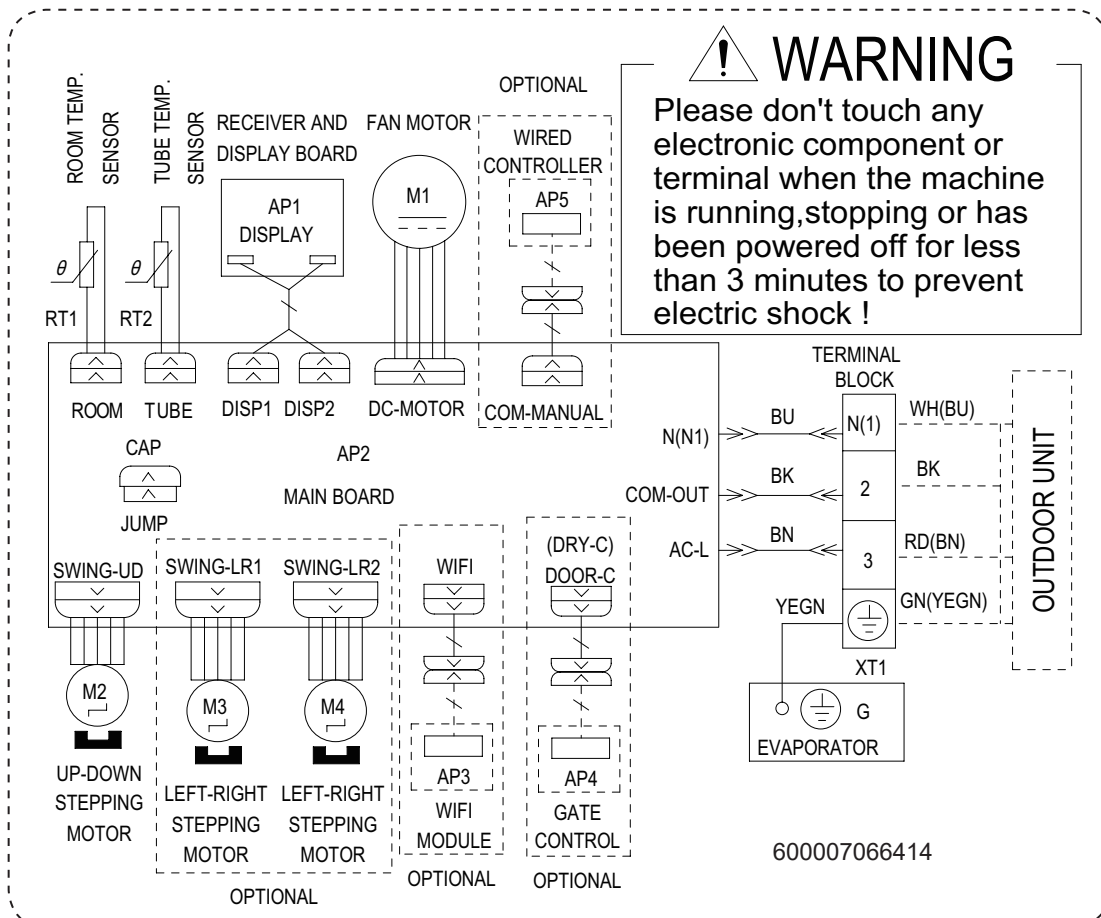

INTENTIONALLY BLANK

5. Electrical Part

• Outdoor Unit

4LIV30HP230V1AO 4LIV36HP230V1AO

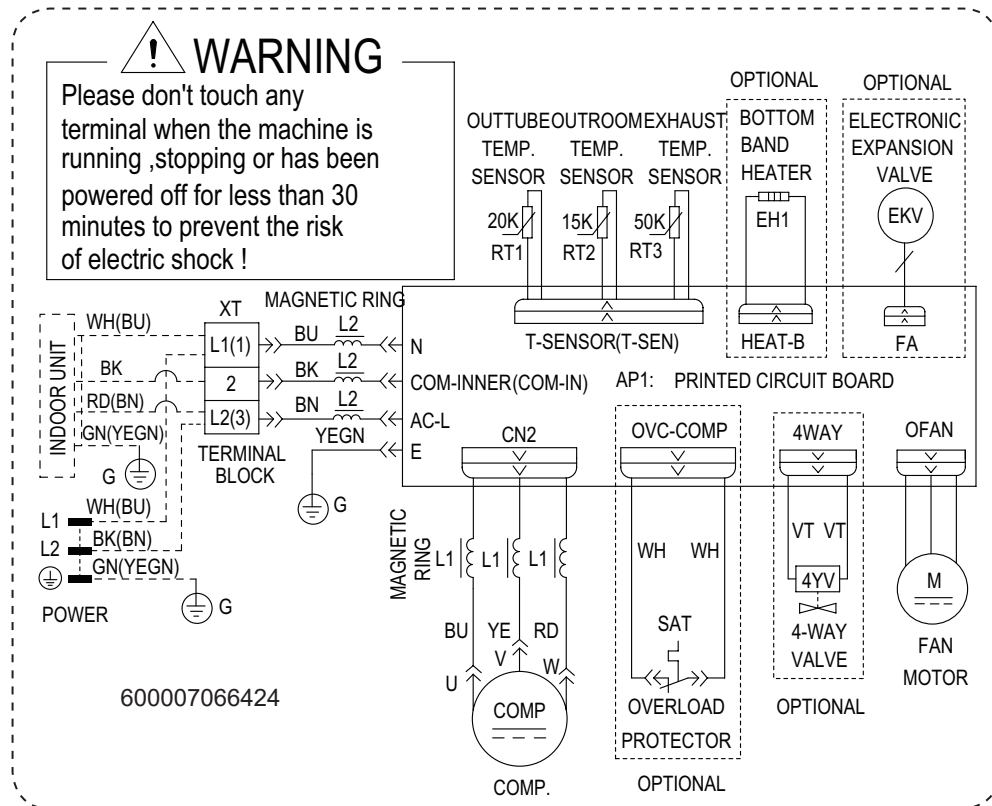

These wiring diagrams are subject to change without notice; please refer to the one supplied with the unit.

5. Electrical Part

5.2 PCB Printed Diagram

Indoor Unit

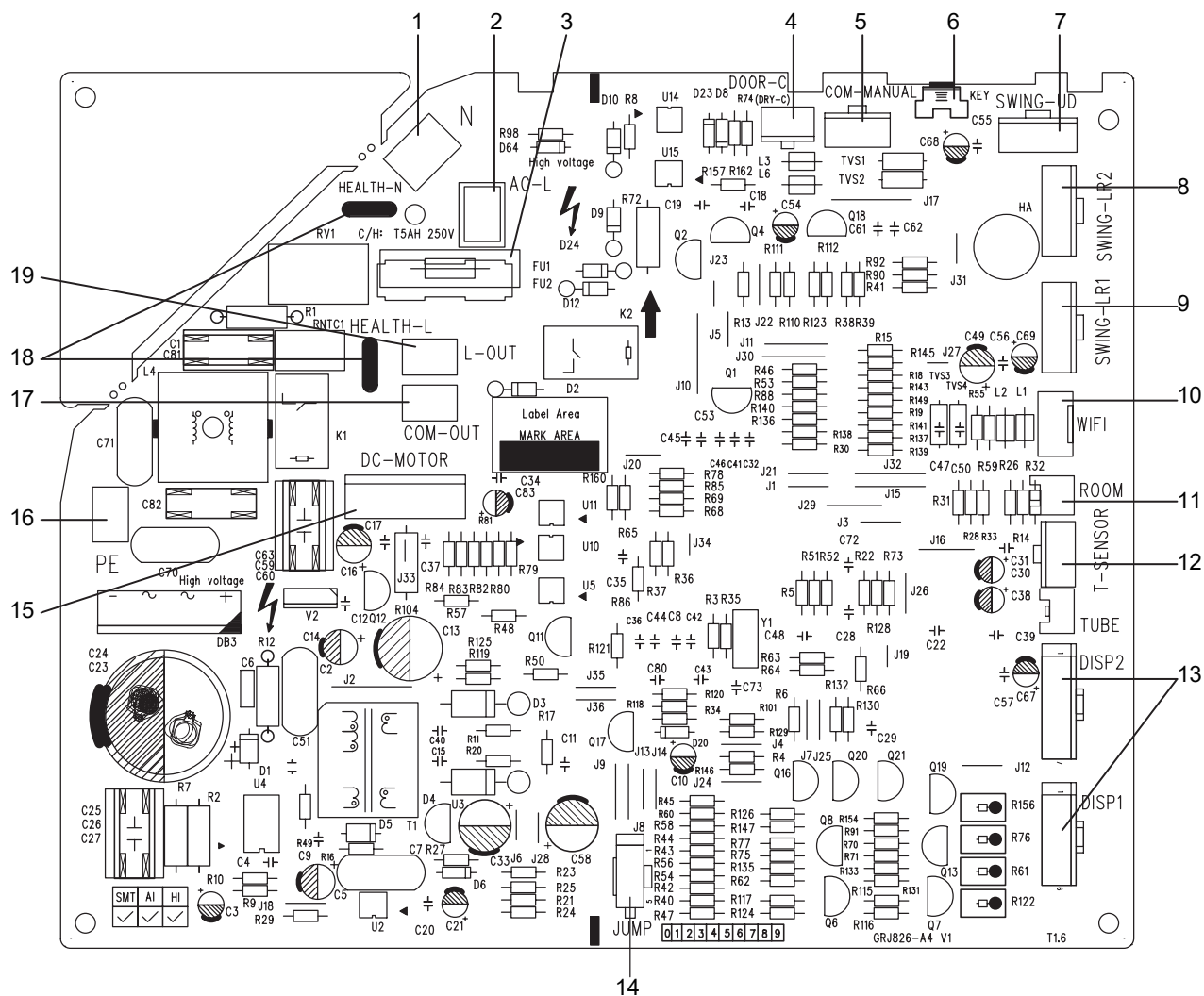

No.	Name	No.	Name
1	Neutral wire	11	Ambient temperature sensor
2	Live wire	12	Tube temperature sensor
3	Fuse	13	Display board
4	Door control	14	Jumper cap
5	Wired controller	15	DC fan
6	Auto button	16	Earthing wire
7	Up&down swing	17	Communication wire
8	Left&right swing 2	18	Live line for AC contactor
9	Left&right swing 1	19	Cold plasma
10	WiFi		

6. Function and Control

6.1 Remote Controller Introduction

Buttons on remote controller for YAP1FB2F (WiFi)



Introduction for icons on display screen

	I feel	
	Set fan speed	
	Turbo mode	
	Send signal	
Operation mode		Auto mode
		Cool mode
		Dry mode
		Fan mode
		Heat mode
	Sleep mode	
	8°C heating function	
	Power limiting operation	
	Health mode	
	Scavenging function	
	X-FAN function	
Temp. display type		Set temp.
		Indoor ambient temp.
		Outdoor ambient temp.
	Clock	
	Set temperature	
	WiFi function	
	Set time	
	TIMER ON / TIMER OFF	
	Left & right swing	
	Up & down swing	
	Child lock	
	Quiet	

NOTE:

- This is a general use remote controller. It could be used for the air conditioner with multifunction. For the functions which the model doesn't have, if press the corresponding button on the remote controller, the unit will keep the original running status.
- After putting through the power, the air conditioner will give out a sound. Power indicator "⏻" is ON. After that, you can operate the air conditioner by using remote controller.
- Under on status, pressing the button on the remote controller, the signal icon "📶" on the display of remote controller will blink once and the air conditioner will give out a "di" sound, which means the signal has been sent to the air conditioner.
- As for the models with functions of WiFi or wired controller, the indoor unit must have been controlled by standard remote controller under auto mode first, and then the function of adjustable temperature under auto mode can be realized by APP or the wired controller.

- This remote controller can adjust the temperature under auto mode. When matching with the unit which is without the function of adjustable temperature under auto mode, the set temperature under auto mode may be invalid, or the displayed set temperature on the unit is not same as that on the remote controller under auto mode.

1. ON/OFF button

Press this button to turn on the unit. Press this button again to turn off the unit.

2. MODE button

Press this button to select your required operation mode.



- When selecting auto mode, air conditioner will operate automatically according to ex-factory setting. Press "FAN" button can adjust fan speed. Press "🌀" / "🌀" button can adjust fan

blowing angle.

- After selecting cool mode, air conditioner will operate under cool mode. Press "△" or "▽" button to adjust set temperature. Press "FAN" button to adjust fan speed. Press "扇" / "↻" button to adjust fan blowing angle.

- When selecting dry mode, the air conditioner operates at low speed under dry mode. Under dry mode, fan speed can't be adjusted. Press "扇" / "↻" button to adjust fan blowing angle.

- When selecting fan mode, the air conditioner will only blow fan, no cooling and no heating. All indicators are OFF. Press "FAN" button to adjust fan speed. Press "扇" / "↻" button to adjust fan blowing angle.

- When selecting heating mode, the air conditioner operates under heat mode. Press "△" or "▽" button to adjust set temperature. Press "FAN" button to adjust fan speed. Press "扇" / "↻" button to adjust fan blowing angle. (Cooling only unit won't receive heating mode signal. If setting heat mode with remote controller, press ON/OFF button can't start up the unit).



NOTE:

- For preventing cold air, after starting up heating mode, indoor unit will delay 1~5 minutes to blow air (actual delay time is depend on indoor ambient temperature).

- Set temperature range from remote controller: 61~86°C (61~86°F);

- Under auto mode, temperature can be displayed; Under auto mode, set temperature can be adjusted. This mode indicator is not available for some models.

3. FAN button

This button is used for setting Fan Speed in the sequence that goes from AUTO,  ,  ,  ,  ,  , to  , then back to Auto.

NOTE:

- Under AUTO speed, air conditioner will select proper fan speed automatically according to factory default setting.

It's low fan speed under dry mode.

- X-FAN function: Holding fan speed button for 2s in cool or dry mode, the icon "☼" is displayed and the indoor fan will continue operation for a few minutes in order to dry the indoor unit even though you have turned off the unit. After energization, X-FAN OFF is defaulted. X-FAN is not available in auto, fan or heat mode.

- This function indicates that moisture on evaporator of indoor unit will be blown after the unit is stopped to avoid mould.

- Having set X-FAN function on: After turning off the unit by pressing ON/OFF button, indoor fan will continue running for a few minutes at low speed. In this period, hold fan speed button for 2s to stop indoor fan directly.

Having set X-FAN function off: After turning off the unit by pressing ON/OFF button, the complete unit will be off directly.

4. TURBO button

Under COOL or HEAT mode, press this button to turn to quick COOL or quick HEAT mode. "⊙" icon is displayed on remote controller. Press this button again to exit turbo function and "⊙" icon will disappear. If start this function, the unit will run at super-high fan speed to cool or heat quickly so that the ambient temperature approaches the preset temperature as soon as possible.

5. △ / ▽ button

- Press "△" or "▽" button once increase or decrease set temperature 1°C (°F). Holding "△" or "▽" button, 2s later, set temperature on remote controller will change quickly. On releasing button after setting is finished, temperature indicator on indoor unit will change accordingly.

- When setting T-ON, T-OFF or CLOCK, press "△" or "▽" button to adjust time. (Refer to CLOCK, T-ON, T-OFF buttons)

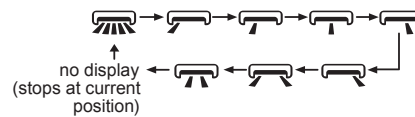

6. 扇 button

Press this button can select left & right swing angle. Fan blow angle can be selected circularly as below:



NOTE:

- Press this button continuously more than 2s, the main unit will swing back and forth from left to right, and then loosen the button, the unit will stop swinging and present position of guide louver will be kept immediately.

- Under left and right swing mode, when the status is switched from off to  , if press this button again 2s later,  status will switch to off status directly; if press this button again within 2s, the change of swing status will also depend on the circulation sequence stated above.

- The function is only available for some models.

7. ↻ button

Press this button can select up & down swing angle. Fan blow angle can be selected circularly as below:

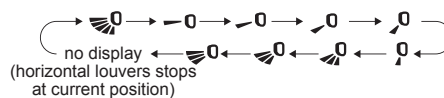

- When selecting "☼" , air conditioner is blowing fan automatically. Horizontal louver will automatically swing up & down at maximum angle.





- When selecting "—", "↻", "☼", "☼", "☼", "☼", "☼", air conditioner is blowing fan at fixed position. Horizontal louver will stop at the fixed position.

- When selecting "☼", "☼", "☼", air conditioner is blowing fan at

fixed angle.



- Hold "  " button above 2s to set your required swing angle. When reaching your required angle, release the button.

NOTE:



- "  ,  ,  " may not be available. When air conditioner receives this signal, the air conditioner will blow fan automatically.
- Press this button continuously more than 2s, the main unit will swing back and forth from up to down, and then loosen the button, the unit will stop swinging and present position of guide louver will be kept immediately.
- Under swing up and down mode, when the status is switched from off to  , if press this button again 2s later,  status will switch to off status directly; if press this button again within 2s, the change of swing status will also depend on the circulation sequence stated above.

8. T-ON / T-OFF button

- T-ON button

"T-ON" button can set the time for timer on. After pressing this button, "  " icon disappears and the word "ON" on remote controller blinks. Press "△" or "▽" button to adjust T-ON setting. After each pressing "△" or "▽" button, T-ON setting will increase or decrease 1min. Hold "△" or "▽" button, 2s later, the time will change quickly until reaching your required time. Press "T-ON" to confirm it. The word "ON" will stop blinking."  " icon resumes displaying. Cancel T-ON: Under the condition that T-ON is started up, press "T-ON" button to cancel it.



- T-OFF button

"T-OFF" button can set the time for timer off. After pressing this button, "  " icon disappears and the word "OFF" on remote controller blinks. Press "△" or "▽" button to adjust T-OFF setting. After each pressing "△" or "▽" button, T-OFF setting will increase or decrease 1min. Hold "△" or "▽" button, 2s later, the time will change quickly until reaching your required time. Press "T-OFF" word "OFF" will stop blinking. "  " icon resumes displaying. Cancel T-OFF: Under the condition that T-OFF is started up, press "T-OFF" button to cancel it.

NOTE:



- Under on and off status, you can set T-OFF or T-ON simultaneously.
- Before setting T-ON or T-OFF, please adjust the clock time.
- After starting up T-ON or T-OFF, set the constant circulating valid.
- After that, air conditioner will be turned on or turned off according to setting time. ON/OFF button has no effect on setting. If you don't need this function, please use remote controller to cancel it.

9. I FEEL button

Press this button to start I FEEL function and "  " will be displayed on the remote controller. After this function is set, the remote controller will send the detected ambient temperature to the controller and the unit will automatically adjust the indoor temperature according to the detected temperature. Press this button again to cancel I FEEL function and "  " will disappear.

- Please put the remote controller near user when this function is set. Do not put the remote controller near the object of high temperature or low temperature in order to avoid detecting inaccurate ambient temperature. When I FEEL function is turned on, the remote controller should be put within the area where indoor unit can receive the signal sent by the remote controller.



10. CLOCK button

Press this button to set clock time. "  " icon on remote controller will blink. Press "△" or "▽" button within 5s to set clock time. Each pressing of "△" or "▽" button, clock time will increase or decrease 1 minute. If hold "△" or "▽" button, 2s later, time will change quickly. Release this button when reaching your required time. Press "CLOCK" button to confirm the time. "  " icon stops blinking.

NOTE:

- Clock time adopts 24-hour mode.
- The interval between two operations can't exceed 5s. Otherwise, remote controller will quit setting status. Operation for T-ON/T-OFF is the same.

11. SLEEP button

- Press this button, can select Sleep 1 ( 1), Sleep 2 ( 2), Sleep 3 ( 3) and cancel the Sleep, circulate between these, after electrified, Sleep Cancel is defaulted.
- Sleep 1 is Sleep mode 1, in Cool modes; sleep status after run for one hour, the main unit setting temperature will increase 1 , two hours, setting temperature increased 2°C, then the unit will run at this setting temperature; In Heat mode: sleep status after run for one hour, the setting temperature will decrease 1 , two hours, setting temperature will decrease 2 , then the unit will run at this setting temperature.
- Sleep 2 is sleep mode 2, that is air conditioner will run according to the presetting a group of sleep temperature curve.
- Sleep 3-the sleep curve setting under Sleep mode by DIY;
(1) Under Sleep 3 mode, press "Turbo" button for a long time, remote controller enters into user individuation sleep setting status, at this time, the time of remote controller will display "1hour", the setting temperature "88" will display the corresponding temperature of last setting sleep curve and blink (The first entering will display according to the initial curve setting value of original factory);
(2) Adjust "+" and "-" button, could change the corresponding setting temperature, after adjusted, press "Turbo" button for confirmation;

(3) At this time, 1hour will be automatically increased at the timer position on the remote control, (that are "2hours" or "3hours" or "8hours"), the place of setting temperature "88" will display the corresponding temperature of last setting sleep curve and blink;

(4) Repeat the above step (2)~(3) operation, until 8 hours temperature setting finished, sleep,curve setting finished, at this time, the remote controller will resume the original timer display; temperature display will resume to original setting temperature.

● Sleep3- the sleep curve setting under Sleep mode by DIY could be inquired:

The user could accord to sleep curve setting method to inquire the presetting sleep curve, enter into user individuation sleep setting status, but do not change the temperature, press "Turbo" button directly for confirmation. Note: In the above presetting or enquiry procedure, if continuously within 10s, there is no button pressed, the sleep curve setting within 10s, there is no button pressed, the sleep curve setting status will be automatically quit and resume to display the original displaying. In the presetting or enquiry procedure, press "ON/OFF" button, "Mode" button, "Sleep" button, the sleep curve setting or enquiry status will quit similarly.

12. WiFi button

Press " WiFi " button to turn on WiFi function, "WiFi " icon will be displayed on the remote controller; Hold " WiFi " button for 5s to turn off WiFi function and " WiFi " icon will disappear.

Under off status, press "MODE" and " WiFi " buttons simultaneously for 1s, WiFi module will restore factory settings.

NOTE:

- This function is only available for some models.

13. 睡眠/净化 button

Press this button to achieve the on and off of health and scavenging functions in operation station. Press this button for the first time to start scavenging function; LCD displays " 净化 ". Press the button for the second time to start health and scavenging functions simultaneously; LCD displays " 睡眠 " and " 净化 ". Press this button for the third time to quit health and scavenging functions simultaneously. Press the button for the fourth time to start health function; LCD display " 睡眠 ". Press this button again to repeat the operation above.

NOTE:

- This function is applicable to partial of models.

14. LIGHT button

Press this button to turn on or turn off the display light on the indoor unit.

The display light is defaulted on after energization.

15. TEMP button

Press this button, you can see indoor set temperature, indoor

ambient temperature on indoor unit's display. The setting on remote controller is selected circularly as below:



Function introduction for combination buttons

1. Energy-saving function

Under cooling mode, press "TEMP" and "CLOCK" buttons simultaneously to start up or turn off energysaving function. When energy-saving function is started up, "SE" will be shown on remote controller, and air conditioner will adjust the set temperature automatically according to ex-factorysetting to reach to the best energy-saving effect. Press "TEMP" and "CLOCK" buttons simultaneously again to exit energy-saving function.

NOTE:

- Under energy-saving function, fan speed is defaulted at auto speed and it can't be adjusted.
- Under energy-saving function, set temperature can't be adjusted. Press "TURBO" button and the remote controller won't send signal.
- Sleep function and energy-saving function can't operate at the same time. If energy-saving function has been set under cool mode, press sleep button will cancel energy-saving function. If sleep function has been set under cool mode, start up the energy-saving function will cancel sleep function.

2. 8°C heating function

Under heat mode, press "TEMP" and "CLOCK" buttons simultaneously to start up or turn off 8°C heating function. When this function is started up, " 8°C " and " 8°C " will be shown on remote controller, and the air conditioner keep the heating status at 8°C.



Press "TEMP" and "CLOCK" buttons simultaneously again to exit 8°C heating function.

NOTE:

- Under 8°C heating function, fan speed is defaulted at auto speed and it can't be adjusted.
- Under 8°C heating function, set temperature can't be adjusted. Press "TURBO" button and the remote controller won't send signal.
- Sleep function and 8°C heating function can't operate at the same time. If 8°C heating function has been set under heat mode, press sleep button will cancel 8°C heating function. If sleep function has been set under heat mode, start up the 8°C heating function will cancel sleep function.
- Under °F temperature display, the remote controller will display 46°F heating.

3. Child lock function

Press "△" and "▽" simultaneously to turn on or turn off child lock

function. When child lock function is on, "  " icon is displayed on remote controller. If you operate the remote controller, the "  " icon will blink three times without sending signal to the unit.

4. Temperature display switchover function

Under OFF status, press "▽" and "MODE" buttons simultaneously to switch temperature display between °C and °F.

5. Auto clean function

Under unit off status, hold "MODE" and "FAN" buttons simultaneously for 5s to turn on or turn off the auto clean function. When the auto clean function is turned on, indoor unit displays "CL" . During the auto clean process of evaporator, the unit will perform fast cooling or fast heating. There may be some noise, which is the sound of flowing liquid or thermal expansion or cold shrinkage. The air conditioner may blow cool or warm air, which is a normal phenomenon. During cleaning process, please make sure the room is well ventilated to avoid affecting the comfort.

NOTE:



- The auto clean function can only work under normal ambient temperature. If the room is dusty, clean it once a month; if not, clean it once every three months. After the auto clean function is turned on, you can leave the room. When auto clean is finished, the air conditioner will enter standby status.
- This function is only available for some models.

6. function

Press "MODE" and "SLEEP" buttons simultaneously to start  function.

 function is for limiting power of the whole unit. Press this button, the remote controller will circularly display as the following:



- Maximum power limited under the  mode is lower than that of  mode.
- If you want to cancel the power limiting function, press the button  till the icon in remote controller is not displayed.
- When the remote controller is turned off, power limiting function is cancelled. If you want to activate the function, please repress this button.

- If the current power is lower than the maximum power of  mode, then the power will not be limited after entering into such mode.
- For the model with one outdoor unit and two indoor units, if any one of indoor units enters into power limiting function, the outdoor unit will enter into the set limiting power mode of indoor unit; when two indoor units enter into power limiting mode, then the power of outdoor unit will be limited according to the lower power of the two indoor units.

NOTE:

- This function is only available for some models.

Replacement of batteries in remote controller

1. Lift the cover along the direction of arrow (as shown in Fig 1 ①).
2. Take out the original batteries (as shown in Fig 1 ②).
3. Place two 7# (AAA 1.5V) dry batteries, and make sure the position of " + " polar and " - " polar is correct (as shown in Fig 2 ③).
4. Reinstall the cover (as shown in Fig 2 ④).

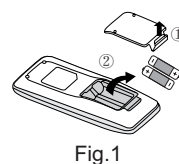

Fig.1

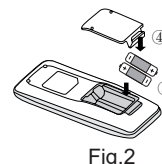

Fig.2

NOTICE:

- During operation, point the remote control signal sender at the receiving window on indoor unit.
- The distance between signal sender and receiving window should be no more than 8m, and there should be no obstacles between them.
- Signal may be interfered easily in the room where there is fluorescent lamp or wireless telephone; remote controller should be close to indoor unit during operation.
- Replace new batteries of the same model when replacement is required.
- When you don't use remote controller for a long time, please take out the batteries.
- If the display on remote controller is fuzzy or there's no display, please replace batteries.

6. Function and Control

YAN1F6F(WiFi)

Buttons on remote controller



Introduction for buttons on remote controller

NOTE:

- This is a general use remote controller, it could be used for the air conditioners with multifunction; For some function, which the model doesn't have, if press the corresponding button on the remote controller that the unit will keep the original running status.
- After putting through the power, the air conditioner will give out a sound. Power indicator "U" is ON. After that, you can operate the air conditioner by using remote controller.
- Under on status, pressing the button on the remote controller, the signal icon "U" on the display of remote controller will blink once and the air conditioner will give out a "di" sound, which means the signal has been sent to the air conditioner.
- Under off status, set temperature and clock icon will be displayed on the display of remote controller (If timer on, timer off and light functions are set, the corresponding icons will be displayed on the display of remote controller at the same time); Under on status, the display will show the corresponding set function icons.

button

Press this button to turn on the unit. Press this button again to turn off the unit.

























button

Press this button to select your required operation mode.



- When selecting auto mode, air conditioner will operate automatically according to ex-factory setting. Under auto mode, temperature can be displayed. Under auto mode, set temperature can be adjusted. Press "FAN" button can adjust fan speed. Press "SWING" button can adjust fan blowing angle.
- After selecting cool mode, air conditioner will operate under cool mode. Cool indicator on indoor unit is ON (This indicator is not available for some models). Press "▲" or "▼" button to adjust set temperature. Press "FAN" button to adjust fan speed. Press "SWING" button to adjust fan blowing angle.
- When selecting dry mode, the air conditioner operates at low speed under dry mode. Dry indicator on indoor unit is ON (This indicator is not available for some models). Under dry mode, fan speed can't be adjusted. Press "SWING" button to adjust fan blowing angle.
- When selecting fan mode, the air conditioner will only blow fan, no cooling and no heating. Press "FAN" button to adjust fan speed. Press "SWING" button to adjust fan blowing angle.
- When selecting heat mode, the air conditioner operates under heat mode. Heat indicator on indoor unit is ON (This indicator is not available for some models). Press "▲" or "▼" button to adjust set temperature. Press "FAN" button to adjust fan speed. Press "SWING" button to adjust fan blowing angle.

Introduction for icons on display screen

	I feel	
	Set fan speed	
	Turbo mode	
	Send signal	
Operation mode		Auto mode
		Cool mode
		Dry mode
		Fan mode
		Heat mode
	Sleep mode	
	8°C heating function	
	Health mode	
	Scavenging function	
	X-FAN function	
Temp. display type		Set temp.
		Indoor ambient temp.
		Outdoor ambient temp.
	Clock	
	Set temperature	
	WiFi function	
	Set time	
	TIMER ON / TIMER OFF	
	Light	
	Up & down swing	
	Child lock	

6. Function and Control

NOTE:

- For preventing cold air, after starting up heat mode, indoor unit will delay 1~5 minutes to blow air (Actual delay time depends on indoor ambient temperature).
- Set temperature range from remote controller: 16~30°C (61~86°F); Fan speed: auto, low speed, medium speed, high speed.
- This mode indicator is not available for some models.
- Cooling only unit won't receive heat mode signal. If setting heat mode with remote controller, press "U" button can't start up the unit.

FAN button

Press this button can set fan speed circularly as: auto (AUTO), low (▲), medium (▲▲), high (▲▲▲).

NOTE:

- Under AUTO speed, air conditioner will select proper fan speed automatically according to factory default setting.
- Fan speed under dry mode is low speed.
- X-FAN function: Hold fan speed button for 2s in COOL or DRY mode, the icon "⊕" is displayed and the indoor fan will continue operation for a few minutes in order to dry the indoor unit even though you have turned off the unit. After energization, X-FAN OFF is defaulted. X-FAN is not available in AUTO, FAN or HEAT mode. This function indicates that moisture on evaporator of indoor unit will be blown after the unit is stopped to avoid mould.
- Having set X-FAN function on: After turning off the unit by pressing "U" button, indoor fan will continue running for a few minutes at low speed. In this period, hold fan speed button for 2s to stop indoor fan directly.
- Having set X-FAN function off: After turning off the unit by pressing "U" button, the complete unit will be off directly.

SWING button

Press this button can select up & down swing angle. Fan blow angle can be selected circularly as below:

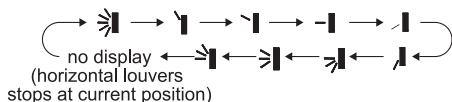

- When selecting "↗", air conditioner is blowing fan automatically. Horizontal louver will automatically swing up & down at maximum angle.
- When selecting "↖", air conditioner is blowing fan at fixed position. Horizontal louver will stop at the fixed position.
- When selecting "↗", air conditioner is blowing fan at fixed angle. Horizontal louver will send air at the fixed angle.
- Hold "↗" button above 2s to set your required swing angle. When reaching your required angle, release the button.

NOTE:

- "↗, ↖, ↗" may not be available. When air conditioner receives this signal, the air conditioner will blow fan automatically.

TURBO button

Under cool or heat mode, press this button to turn to quick cool or quick heat mode. "⊕" icon is displayed on remote controller.

Press this button again to exit turbo function and "⊕" icon will disappear.

▲ / ▼ button

Press "▲" or "▼" button once increase or decrease set temperature 1°C(°F). Holding "▲" or "▼" button, 2s later, set temperature on remote controller will change quickly. On releasing button after setting is finished, temperature indicator on indoor unit will change accordingly. (Temperature can't be adjusted under auto mode)

When setting TIMER ON, TIMER OFF or CLOCK, press "▲" or "▼" button to adjust time. (Refer to CLOCK, TIMER ON, TIMER OFF buttons)

SLEEP button

Under cool or heat mode, press this button to start up sleep function.

"☾" icon is displayed on remote controller.

Press this button again to cancel sleep function and "☾" icon will disappear.

TEMP button

By pressing this button, you can see indoor set temperature, indoor ambient temperature or outdoor ambient temperature on indoor unit's display. The setting on remote controller is selected circularly as below:

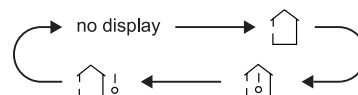

- When selecting "🏠" or no display with remote controller, temperature indicator on indoor unit displays set temperature.
- When selecting "🏠" with remote controller, temperature indicator on indoor unit displays indoor ambient temperature.
- When selecting "🏠" with remote controller, temperature indicator on indoor unit displays outdoor ambient temperature.

NOTE:

- Outdoor temperature display is not available for some models. At that time, indoor unit receives "🏠" signal, while it displays indoor set temperature.
- It's defaulted to display set temperature when turning on the unit. There is no display in the remote controller.
- Only for the models whose indoor unit has dual-8 display.
- When selecting displaying of indoor or outdoor ambient temperature, indoor temperature indicator displays corresponding temperature and automatically turn to display set temperature after three or five seconds.

WiFi button

Press "WiFi" button to turn on WiFi function, "WiFi" icon will be displayed on the remote controller.

Hold "WiFi" button for 5s to turn off WiFi function and "WiFi" icon will disappear.

Under off status, press "MODE" and "WiFi" buttons simultaneously for 1s, WiFi module will restore factory settings.

NOTE:

- This function is only available for some models.

6. Function and Control

button

Press this button to turn off display light on indoor unit. "☀" icon on remote controller disappears.

Press this button again to turn on display light. "☀" icon is displayed.

button

Press this button to set clock time. "🕒" icon on remote controller will blink. Press "▲" or "▼" button within 5s to set clock time. Each pressing of "▲" or "▼" button, clock time will increase or decrease 1 minute. If hold "▲" or "▼" button, 2s later, time will change quickly. Release this button when reaching your required time. Press "CLOCK" button to confirm the time. "🕒" icon stops blinking.

NOTE:

- Clock time adopts 24-hour mode.
- The interval between two operations can't exceeds 5s. Otherwise, remote controller will quit setting status. Operation for TIMER ON/TIMER OFF is the same.

button

• TIMER ON button

"TIMER ON" button can set the time for timer on. After pressing this button, "🕒" icon disappears and the word "ON" on remote controller blinks. Press "▲" or "▼" button to adjust TIMER ON setting. After each pressing "▲" or "▼" button. TIMER ON setting will increase or decrease 1min. Holding "▲" or "▼" button, 2s later, the time will change quickly until reaching your required time. Press "TIMER ON" to confirm it. The word "ON" will stop blinking. "🕒" icon resumes displaying. Cancel TIMER ON: Under the condition that TIMER ON is started up, press "TIMER ON" button to cancel it.

• TIMER OFF button

"TIMER OFF" button can set the time for timer off. After pressing this button, "🕒" icon disappears and the word "OFF" on remote controller blinks. Press "▲" or "▼" button to adjust TIMER OFF setting. After each pressing "▲" or "▼" button, TIMER OFF setting will increase or decrease 1min. Holding "▲" or "▼" button, 2s later, the time will change quickly until reaching your required time.

Press "TIMER OFF" and the word "OFF" will stop blinking. "🕒" icon resumes displaying.

Cancel TIMER OFF. Under the condition that TIMER OFF is started up, press "TIMER OFF" button to cancel it.

NOTE:

- Under on and off status, you can set TIMER OFF or TIMER ON simultaneously.
- Before setting TIMER ON or TIMER OFF, please adjust the clock time.
- After starting up TIMER ON or TIMER OFF, set the constant circulating valid. After that, air conditioner will be turned on or turned off according to setting time. "⏻" button has no effect on setting. If you don't need this function, please use remote controller to cancel it.

Function introduction for combination buttons

Energy-saving function

Under cooling mode, press "TEMP" and "CLOCK" buttons simultaneously to start up or turn off energy-saving function. When energy-saving function is started up, "SE" will be shown on remote controller, and air conditioner will adjust the set temperature automatically according to ex-factory setting to reach to the best energy-saving effect.

Press "TEMP" and "CLOCK" buttons simultaneously again to exit energy-saving function.

NOTE:

- Under energy-saving function, fan speed is defaulted at auto speed and it can't be adjusted.
- Under energy-saving function, set temperature can't be adjusted. Press "TURBO" button and the remote controller won't send signal.
- Sleep function and energy-saving function can't operate at the same time. If energy-saving function has been set under cool mode, press sleep button will cancel energy-saving function. If sleep function has been set under cool mode, start up the energy-saving function will cancel sleep function.

8°C heating function

Under heat mode, press "TEMP" and "CLOCK" buttons simultaneously to start up or turn off 8°C heating function. When this function is started up, "🌡" and "8°C" will be shown on remote controller, and the air conditioner keep the heating status at 8°C. Press "TEMP" and "CLOCK" buttons simultaneously again to exit 8°C heating function.

NOTE:

- Under 8°C heating function, fan speed is defaulted at auto speed and it can't be adjusted.
- Under 8°C heating function, set temperature can't be adjusted. Press "TURBO" button and the remote controller won't send signal.
- Sleep function and 8°C heating function can't operate at the same time. If 8°C heating function has been set under heat mode, press "SLEEP" button will cancel 8°C heating function. If sleep function has been set under heat mode, start up the 8°C heating function will cancel sleep function.
- Under °F temperature display, the remote controller will display 46°F heating.

Child lock function

Press "▲" or "▼" simultaneously to turn on or turn off child lock function. When child lock function is on, "🔒" icon is displayed on remote controller. If you operate the remote controller, the "🔒" icon will blink three times without sending signal to the unit.

Temperature display switchover function

Under OFF status, press "▼" and "MODE" buttons

6. Function and Control

6.2 GREE+ App Operation Manual

Control Flow Chart

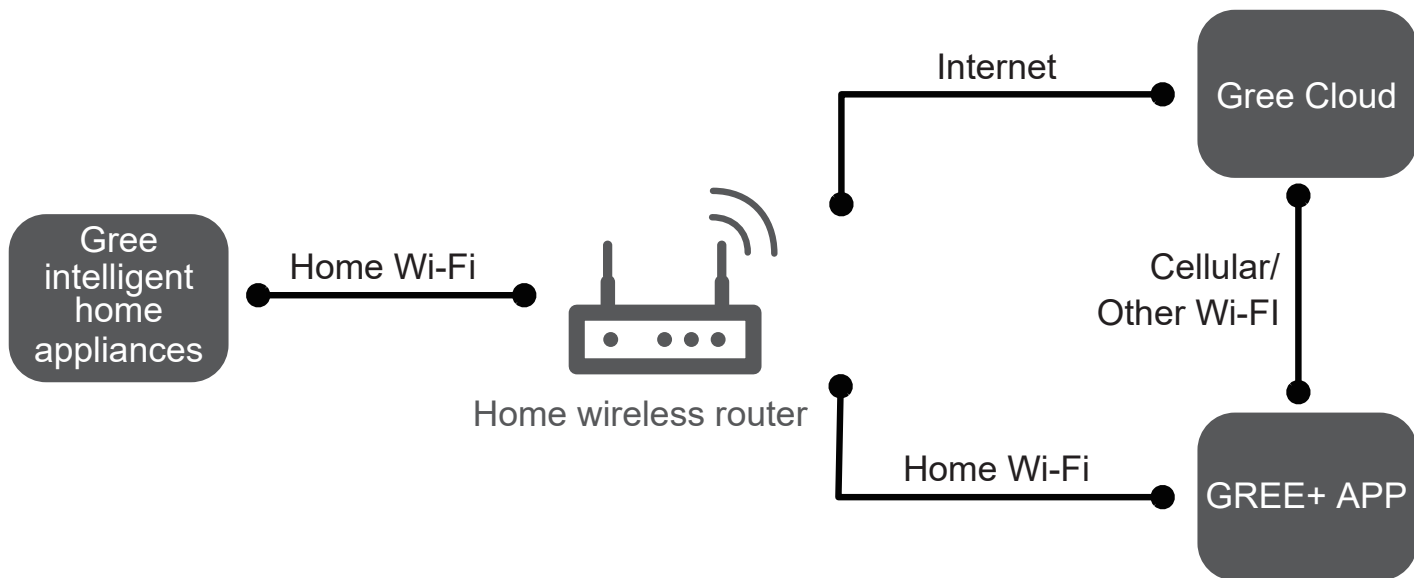

Operating Systems

Requirement for User's smart phone:



iOS system
Support iOS7.0 and
above version



Android system
Support Android 4.4 and
above version

Download and installation



GREE+ App Download Linkage

Scan the QR code or search "GREE+" in the application market to download and install it. When "GREE+" App is installed, register the account and add the device to achieve long-distance control and LAN control of Gree smart home appliances.

For more information, please refer to "Help" in App.

6. Function and Control

6.3 Ewpe Smart App Operation Manual

Control Flow Chart

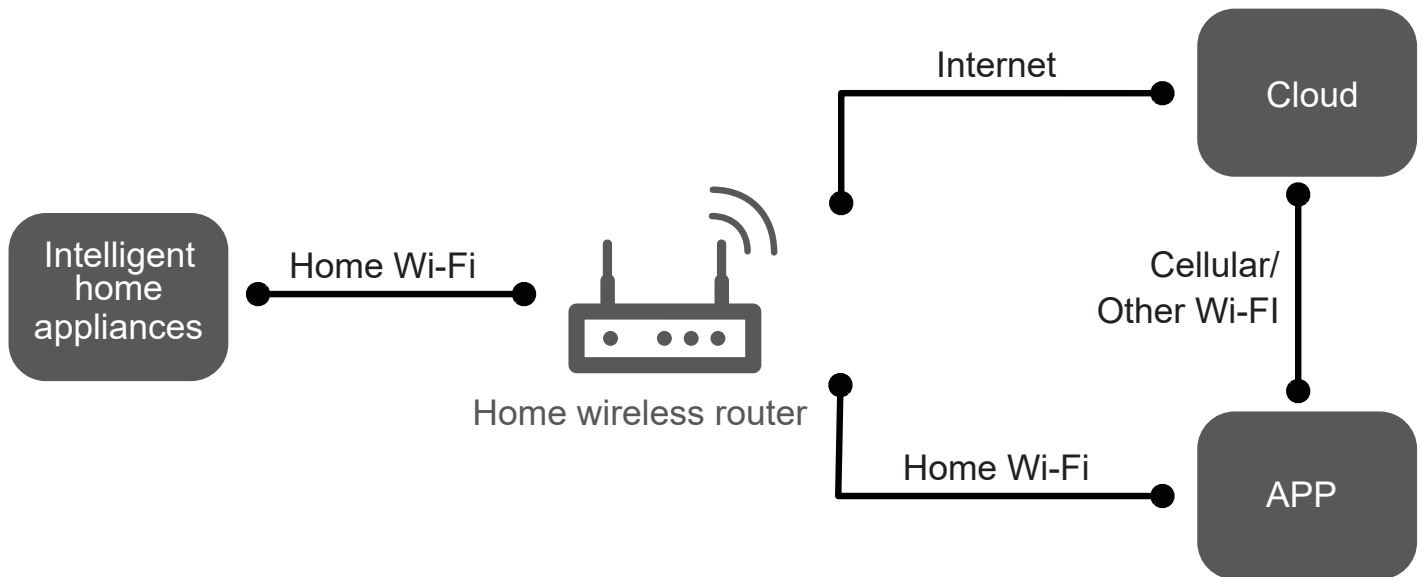

Operating Systems

Requirement for User's smart phone:



iOS system
Support iOS7.0 and
above version



Android system
Support Android 4.4 and
above version

Download and installation



App Download Linkage

Scan the QR code or search "Ewpe Smart" in the application market to download and install it. When "Ewpe Smart" App is installed, register the account and add the device to achieve long-distance control and LAN control of smart home appliances. For more information, please refer to "Help" in App.

6. Function and Control

6.4 Brief Description of Modes and Functions

1. Temperature Parameters

Indoor preset temperature (T_{preset})

Indoor ambient temperature ($T_{\text{amb.}}$)

2. Basic Functions

Once energized, in no case should the compressor be restarted within less than 3 minutes. In the situation that memory function is available, for the first energization, if the compressor is at stop before de-energization, the compressor will be started without a 3-minute lag; if the compressor is in operation before de-energization, the compressor will be started with a 3-minute lag; and once started, the compressor will not be stopped within 6 minutes regardless of changes in room temperature;

(1) Cooling Mode

① Working conditions and process of cooling

When $T_{\text{amb.}} \geq T_{\text{preset}}$, the unit will enter cooling operation, in which case the indoor fan, the outdoor fan and the compressor will work and the indoor fan will run at preset speed.

When $T_{\text{amb.}} \leq T_{\text{preset}} + 28.4^\circ\text{F}$, the compressor will stop, the outdoor fan will stop with a time lag of 60s, and the indoor fan will run at preset speed.

When $T_{\text{preset}} + 28.4^\circ\text{F} < T_{\text{amb.}} < T_{\text{preset}}$, the unit will remain at its previous state.

Under this mode, the four-way valve will be de-energized and temperature can be set within a range from $61^\circ\text{F} \sim 86^\circ\text{F}$. If the compressor is shut down for some reason, the indoor fan and the swing device will operate at original state.

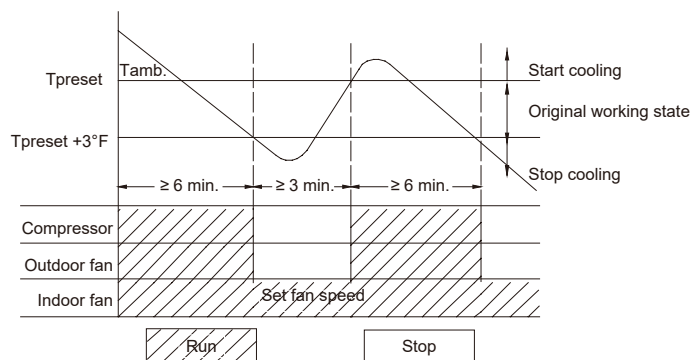

② Protection

Antifreeze protection

Under cooling and dehumidifying mode, 6 minutes after the compressor is started:

If $T_{\text{evap}} \leq 35.6^\circ\text{F}$, the compressor will operate at reduced frequency.

If $T_{\text{evap}} \leq 30.2^\circ\text{F}$ is detected for durative 3 minutes, the compressor will stop, and after 60 seconds, the outdoor fan will stop; and under cooling mode, the indoor fan and the swing motor will remain at the original state.

If $T_{\text{evap}} \geq 42.8^\circ\text{F}$ and the compressor has remained at OFF for at least 3 minutes, the compressor will resume its original operation state.

Total current up and frequency down protection

If $I_{\text{total}} \leq 16\text{A}$, frequency rise will be allowed; if $I_{\text{total}} \geq 17\text{A}$, frequency rise will not be allowed; if $I_{\text{total}} \geq 18\text{A}$, the compressor will run at reduced frequency; and if $I_{\text{total}} \geq 20\text{A}$, the compressor will stop and

the outdoor fan will stop with a time lag of 60s.

(2) Dehumidifying Mode

① Working conditions and process of dehumidifying

If $T_{\text{amb.}} > T_{\text{preset}}$, the unit will enter cooling and dehumidifying mode, in which case the compressor and the outdoor fan will operate and the indoor fan will run at low speed.

If $T_{\text{preset}} + 28.4^\circ\text{F} \leq T_{\text{amb.}} \leq T_{\text{preset}}$ the compressor remains at its original operation state.

If $T_{\text{amb.}} < T_{\text{preset}}$, the compressor will stop, the outdoor fan will stop with a time lag of 60s, and the indoor fan will operate at low speed.

② Protection

Protection is the same as that under the cooling mode.

(3) Heating Mode

① Working conditions and process of heating

If $T_{\text{amb.}} \leq T_{\text{preset}} + 35.6^\circ\text{F}$ ($T_{\text{indoor ambient}} \leq T_{\text{setting}} + 2^\circ\text{C}$, start with heating mode), the unit enters heating mode, in which case the four-way valve, the compressor and the outdoor fan will operate simultaneously, and the indoor fan will run at preset speed in the condition of preset cold air prevention.

If $T_{\text{amb.}} \geq T_{\text{preset}} + 37.4^\circ\text{F}$ ($T_{\text{indoor ambient}} \geq T_{\text{setting}} + 3^\circ\text{C}$, it stops when reaches temperature point), the compressor will stop, the outdoor fan will stop with a time lag of 60s, and the indoor fan will stop after 60-second blow at low speed.

If $T_{\text{preset}} < T_{\text{amb.}} < T_{\text{preset}} + 37.4^\circ\text{F}$ ($T_{\text{setting}} < T_{\text{indoor ambient}} < T_{\text{setting}} + 3^\circ\text{C}$, maintain heating mode), the unit will maintain its original operating status.

Under this mode, the four-way valve is energized and temperature can be set within a range of $61^\circ\text{F} \sim 86^\circ\text{F}$. The operating symbol, the heating symbol and preset temperature are revealed on the display.

② Condition and process of defrost

When duration of successive heating operation is more than 45 minutes, or accumulated heating time more than 90 minutes, and one of the following conditions is reached, the unit will enter the defrost mode after 3 minutes.

- $T_{\text{outdoor amb.}} \geq 41^\circ\text{F}$, $T_{\text{outdoor pipe}} \leq 28.4^\circ\text{F}$;
- $28.4^\circ\text{F} \leq T_{\text{outdoor amb.}} \leq 41^\circ\text{F}$, $T_{\text{outdoor pipe}} - T_{\text{compensation}} \leq 23^\circ\text{F}$
- $23^\circ\text{F} < T_{\text{outdoor amb.}} \leq 28.4^\circ\text{F}$, $T_{\text{outdoor pipe}} - T_{\text{compensation}} \leq 17.6^\circ\text{F}$;
- $14^\circ\text{F} < T_{\text{outdoor amb.}} < 23^\circ\text{F}$, $T_{\text{outdoor pipe}} - T_{\text{compensation}} \leq T_{\text{outdoor amb.}} + 26.6^\circ\text{F}$;
- $T_{\text{outdoor amb.}} < 14^\circ\text{F}$, $T_{\text{outdoor pipe}} - T_{\text{compensation}} \leq T_{\text{outdoor amb.}} + 26.6^\circ\text{F}$;

After energization, when defrosting for the first time $T_{\text{compensation}} = 0^\circ\text{F}$. If it is not the firstly time for defrosting, the $T_{\text{compensation}}$ is determined by the $T_{\text{outdoor pipe}}$ of last time quitting defrosting.

- $T_{\text{outdoor pipe}} > 35.6^\circ\text{F}$, $T_{\text{compensation}} = 32^\circ\text{F}$;
- $T_{\text{outdoor pipe}} \leq 35.6^\circ\text{F}$, $T_{\text{compensation}} = 33.8^\circ\text{F}$.

At that time, the indoor fan stops and the compressor stops, and after 60 seconds the outdoor fan will stop, and then after 30 seconds, the four-way valve will stop. After 30 seconds, the compressor is initiated for raising the frequency to defrost frequency.

When the compressor has operated under defrost mode for 10 minutes, or $T_{\text{outdoor tube}} \geq 50^\circ\text{F}$, the compressor will be converted to 46Hz operation. After 30 seconds, the compressor will stop.

6. Function and Control

And after another 30 seconds, the four-way valve will be opened, and after 60 seconds, the compressor and the outdoor fan will be started, the indoor fan will run under preset cold air prevention conditions, and H1 will be displayed at temperature display area on the display panel. Defrost frequency is 70 Hz.

3. Protection

Cold air prevention

The unit is started under heating mode (the compressor is ON):

① In the case of $T_{\text{indoor amb.}} < 75^{\circ}\text{F}$: if $T_{\text{tube}} \leq 104^{\circ}\text{F}$ and the indoor fan is at stop state, the indoor fan will begin to run at low speed with a time lag of 2 minutes. Within 2 minutes, if $T_{\text{tube}} > 104^{\circ}\text{F}$, the indoor fan also will run at low speed; and after 1 minute operation at low speed, the indoor fan will be converted to operation at preset speed. Within 1 minute low speed operation or 2 minute non-operation, if $T_{\text{tube}} > 108^{\circ}\text{F}$, the fan will run at present speed.

② In the case of $T_{\text{indoor amb.}} < 75^{\circ}\text{F}$: if $T_{\text{tube}} \leq 108^{\circ}\text{F}$, the indoor fan will run at low speed, and after one minute, the indoor fan will be converted to preset speed. Within 1 minute low speed operation, if $T_{\text{tube}} > 104^{\circ}\text{F}$, the indoor fan will be converted to preset speed. Note: $T_{\text{indoor amb.}}$ indicated in ① and ② refers to, under initially heating mode, the indoor ambient temperature before the command to start the compressor is performed according to the program, or after the unit is withdrawn from defrost, the indoor ambient temperature before the defrost symbol is cleared.

Total current up and frequency down protection

If the total current $I_{\text{total}} \leq 16\text{A}$, frequency rise will be allowed; if $I_{\text{total}} \geq 17\text{A}$, frequency rise will not be allowed; if $I_{\text{total}} \geq 18\text{A}$, the compressor will run at reduced frequency; and if $I_{\text{total}} \geq 20\text{A}$, the compressor will stop and the outdoor fan will stop with a time lag of 60s.

(4) Fan Mode

Under the mode, the indoor fan will run at preset speed and the compressor, the outdoor fan, the four-way valve and the electric heater will stop.

Under the mode, temperature can be set within a range of $61^{\circ}\text{F} \sim 86^{\circ}\text{F}$.

(5) AUTO Mode

① Working conditions and process of AUTO mode

Under AUTO mode, standard cooling temperature T_{preset} is 77°F and standard heating temperature T_{preset} is 68°F .

a. Once energized, if $T_{\text{amb.}} \leq 71.6^{\circ}\text{F}$, the unit will be started under heating mode; if $71.6^{\circ}\text{F} < T_{\text{amb.}} < 78.8^{\circ}\text{F}$, the unit will run under fan mode and the run indicator will be bright; and if $T_{\text{amb.}} \geq 78.8^{\circ}\text{F}$, the unit will be started under cooling mode.

b. Under AUTO mode, if $T_{\text{amb.}} \geq T_{\text{preset}} + 1.8^{\circ}\text{F}$ is detected, the unit will select to run under cooling mode, in which case implicit preset temperature is 77°F ; if $T_{\text{amb.}} \leq T_{\text{preset}} - 1.8^{\circ}\text{F}$, the compressor will stop, the outdoor fan will stop with a time lag of 1 minute, and the indoor fan will run at preset speed; and if $T_{\text{preset}} - 1.8^{\circ}\text{F} < T_{\text{amb.}} < T_{\text{preset}} + 1.8^{\circ}\text{F}$, the unit will remain at its original state.

c. Under AUTO mode, if $T_{\text{amb.}} \leq T_{\text{preset}} + 3.6^{\circ}\text{F}$ is detected, the unit will select to run under heating mode, in which case implicit preset temperature is 64°F ; if $T_{\text{amb.}} \geq T_{\text{preset}} + 9^{\circ}\text{F}$, the compressor will stop, the outdoor fan will stop with a time lag of 1 minute, and the indoor fan will run under the mode of residue heat

blowing; and if $T_{\text{preset}} + 3.6^{\circ}\text{F} < T_{\text{amb.}} < T_{\text{preset}} + 41^{\circ}\text{F}$, the unit will remain at its original state. The cooling-only unit will run under fan mode.

d. Under AUTO mode, if $71.6^{\circ}\text{F} < T_{\text{amb.}} < 78.8^{\circ}\text{F}$, the unit will remain at its original state.

② Protection

a. In cooling operation, protection is the same as that under the cooling mode;

b. In heating operation, protection is the same as that under the heating mode;

c. When ambient temperature changes, operation mode will be converted preferentially. Once started, the compressor will remain unchanged for at least 6 minutes.

(6) Common Protection Functions and Fault Display under COOL, HEAT, DRY and AUTO Modes

① Overload protection

T_{tube} : measured temperature of outdoor heat exchanger under cooling mode; and measured temperature of indoor heat exchanger under heating mode.

1) Cooling overload

a. If $T_{\text{tube}} \leq 126^{\circ}\text{F}$, the unit will return to its original operation state.

b. If $T_{\text{tube}} \geq 131^{\circ}\text{F}$, frequency rise is not allowed.

c. If $T_{\text{tube}} \geq 136^{\circ}\text{F}$, the compressor will run at reduced frequency.

d. If $T_{\text{tube}} \geq 144^{\circ}\text{F}$, the compressor will stop and the indoor fan will run at preset speed.

2) Heating overload

a. If $T_{\text{tube}} \leq 126^{\circ}\text{F}$, the unit will return to its original operation state.

b. If $T_{\text{tube}} \geq 131^{\circ}\text{F}$, frequency rise is not allowed.

c. If $T_{\text{tube}} \geq 136^{\circ}\text{F}$, the compressor will run at reduced frequency.

d. If $T_{\text{tube}} \geq 144^{\circ}\text{F}$, the compressor will stop and the indoor fan will blow residue heat and then stop.

② Exhaust temperature protection of compressor

If exhaust temperature $\geq 208^{\circ}\text{F}$, frequency is not allowed to rise.

If exhaust temperature $\geq 217^{\circ}\text{F}$, the compressor will run at reduced frequency.

If exhaust temperature $\geq 230^{\circ}\text{F}$, the compressor will stop.

If exhaust temperature $\leq 194^{\circ}\text{F}$, the compressor has stayed at stop for at least 3 minutes, the compressor will resume its operation.

③ Communication fault

If the unit fails to receive correct signals for a duration of 3 minutes, communication fault can be justified and the whole system will stop.

④ Module protection

Under module protection mode, the compressor will stop. When the compressor remains at stop for at least 3 minutes, the compressor will resume its operation. If module protection occurs six times in succession, the compressor will not be started again.

⑤ Overload protection

If temperature sensed by the overload sensor is over 239°F , the compressor will stop and the outdoor fan will stop with a time lag of 30 seconds. If temperature is below 203°F , the overload protection will be relieved.

If voltage on the DC bus is below 150V or over 420V, the compressor will stop and the outdoor fan will stop with a time lag of 30 seconds. When voltage on the DC bus returns to its normal

6. Function and Control

value and the compressor has stayed at stop for at least 3 minutes, the compressor will resume its operation.

⑥ Faults of temperature sensors

Designation of sensors	Faults
Indoor ambient temperature	The sensor is detected to be open-circuited or short-circuited for successive 5 seconds
Indoor tube temperature	The sensor is detected to be open-circuited or short-circuited for successive 5 seconds
Outdoor ambient temperature	The sensor is detected to be open-circuited or short-circuited for successive 30 seconds
Outdoor tube temperature	The sensor is detected to be open-circuited or short-circuited for successive 30 seconds, and no detection is performed within 10 minutes after defrost begins.
Exhaust	After the compressor has operated for 3 minutes, the sensor is detected to be open-circuited or short-circuited for successive 30 seconds.
Overload	After the compressor has operated for 3 minutes, the sensor is detected to be open-circuited or short-circuited for successive 30 seconds.

7. Notes for Installation and Maintenance

Safety Precautions: Important!

Please read the safety precautions carefully before installation and maintenance.

The following contents are very important for installation and maintenance.

Please follow the instructions below.

- The installation or maintenance must accord with the instructions.
- Comply with all national electrical codes and local electrical codes.
- Pay attention to the warnings and cautions in this manual.
- All installation and maintenance shall be performed by distributor or qualified person.
- All electric work must be performed by a licensed technician according to local regulations and the instructions given in this manual.
- Be caution during installation and maintenance. Prohibit incorrect operation to prevent electric shock, casualty and other accidents.

WARNINGS

Electrical Safety Precautions:

1. Cut off the power supply of air conditioner before checking and maintenance.
2. The air condition must apply specialized circuit and prohibit share the same circuit with other appliances.
3. The air conditioner should be installed in suitable location and ensure the power plug is touchable.
4. Make sure each wiring terminal is connected firmly during installation and maintenance.
5. Have the unit adequately grounded. The grounding wire can't be used for other purposes.
6. Must apply protective accessories such as protective boards, cable-cross loop and wire clip.
7. The live wire, neutral wire and grounding wire of power supply must be corresponding to the live wire, neutral wire and grounding wire of the air conditioner.
8. The power cord and power connection wires can't be pressed by hard objects.
9. If power cord or connection wire is broken, it must be replaced by a qualified person.
10. If the power cord or connection wire is not long enough, please get the specialized power cord or connection wire from the manufacture or distributor. Prohibit prolong the wire by yourself.
11. For the air conditioner without plug, an air switch must

be installed in the circuit. The air switch should be all-pole parting and the contact parting distance should be more than 3mm.

12. Make sure all wires and pipes are connected properly and the valves are opened before energizing.
13. Check if there is electric leakage on the unit body. If yes, please eliminate the electric leakage.
14. Replace the fuse with a new one of the same specification if it is burnt down; Don't replace it with a cooper wire or conducting wire.
15. If the unit is to be installed in a humid place, the circuit breaker must be installed.

Installation Safety Precautions:

1. Select the installation location according to the requirement of this manual.(See the requirements in installation part)
2. Handle unit transportation with care; the unit should not be carried by only one person if it is more than 20kg.
3. When installing the indoor unit and outdoor unit, a sufficient fixing bolt must be installed; make sure the installation support is firm.
4. Ware safety belt if the height of working is above 2m.
5. Use equipped components or appointed components during installation.
6. Make sure no foreign objects are left in the unit after finishing installation.

Refrigerant Safety Precautions:

1. When refrigerant leaks or requires discharge during installation, maintenance, or disassembly, it should be handled by certified professionals or otherwise in compliance with local laws and regulations.
2. Avoid contact between refrigerant and fire as it generates poisonous gas; Prohibit prolong the connection pipe by welding.
3. Apply specified refrigerant only. Never have it mixed with any other refrigerant. Never have air remain in the refrigerant line as it may lead to rupture or other hazards.
4. Make sure no refrigerant gas is leaking out when installation is completed.
5. If there is refrigerant leakage, please take sufficient measure to minimize the density of refrigerant.
6. Never touch the refrigerant piping or compressor without wearing glove to avoid scald or frostbite.

Improper installation may lead to fire hazard, explosion, electric shock or injury.

7. Notes for Installation and Maintenance

Safety Precautions for Installing and Relocating the Unit:

To ensure safety, please be mindful of the following precautions.

WARNINGS

1. When installing or relocating the unit, be sure to keep the refrigerant circuit free from air or substances other than the specified refrigerant.

Any presence of air or other foreign substance in the refrigerant circuit will cause system pressure rise or compressor rupture, resulting in injury.

2. When installing or moving this unit, do not charge the refrigerant which is not comply with that on the nameplate or unqualified refrigerant.

Otherwise, it may cause abnormal operation, wrong action, mechanical malfunction or even series safety accident.

3. When refrigerant needs to be recovered during relocating or repairing the unit, be sure that the unit is running in cooling mode. Then, fully close the valve at high pressure side (liquid valve). About 30-40 seconds later, fully close the valve at low pressure side (gas valve), immediately stop the unit and disconnect power. Please note that the time for refrigerant recovery should not exceed 1 minute.

If refrigerant recovery takes too much time, air may be sucked in and cause pressure rise or compressor rupture, resulting in injury.

4. During refrigerant recovery, make sure that liquid valve and gas valve are fully closed and power is disconnected before detaching the connection pipe.

If compressor starts running when stop valve is open and connection pipe is not yet connected, air will be sucked in and cause pressure rise or compressor rupture, resulting in injury.

5. When installing the unit, make sure that connection pipe is securely connected before the compressor starts running.

If compressor starts running when stop valve is open and connection pipe is not yet connected, air will be sucked in and cause pressure rise or compressor rupture, resulting in injury.

6. Prohibit installing the unit at the place where there may be leaked corrosive gas or flammable gas.

If there leaked gas around the unit, it may cause explosion and other accidents.

7. Do not use extension cords for electrical connections. If the electric wire is not long enough, please contact a local service center authorized and ask for a proper electric wire.

Poor connections may lead to electric shock or fire.

8. Use the specified types of wires for electrical connections between the indoor and outdoor units. Firmly clamp the wires so that their terminals receive no external stresses.

Electric wires with insufficient capacity, wrong wire connections and insecure wire terminals may cause electric shock or fire.

8. Installation

8.2 Installation Parts-checking

No.	Name
1	Indoor unit
2	Outdoor unit
3	Connection pipe
4	Drainage pipe
5	Wall-mounting frame
6	Connecting cable(power cord)
7	Wall pipe
8	Sealing gum
9	Wrapping tape
10	Support of outdoor unit
11	Fixing screw
12	Drainage plug(cooling and heating unit)
13	Owners manual, remote controller

⚠ Note:

1. Please contact the local agent for installation.
2. Don't use unqualified power cord.

8.3 Selection of Installation Location

1. Basic Requirement:

Installing the unit in the following places may cause malfunction. If it is unavoidable, please consult the local dealer:

- (1) The place with strong heat sources, vapors, flammable or explosive gas, or volatile objects spread in the air.
- (2) The place with high-frequency devices (such as welding machine, medical equipment).
- (3) The place near coast area.
- (4) The place with oil or fumes in the air.
- (5) The place with sulfured gas.
- (6) Other places with special circumstances.
- (7) The appliance shall not be installed in the laundry.
- (8) It's not allowed to be installed on the unstable or motive base structure (such as truck) or in the corrosive environment (such as chemical factory).

2. Indoor Unit:

- (1) There should be no obstruction near air inlet and air outlet.
- (2) Select a location where the condensation water can be dispersed easily and won't affect other people.
- (3) Select a location which is convenient to connect the outdoor unit and near the power socket.
- (4) Select a location which is out of reach for children.
- (5) The location should be able to withstand the weight of indoor unit and won't increase noise and vibration.
- (6) The appliance must be installed 2.5m above floor.
- (7) Don't install the indoor unit right above the electric appliance.
- (8) Please try your best to keep way from fluorescent lamp.

3. Outdoor Unit:

- (1) Select a location where the noise and outflow air emitted by the outdoor unit will not affect neighborhood.
- (2) The location should be well ventilated and dry, in which the outdoor unit won't be exposed directly to sunlight or strong wind.
- (3) The location should be able to withstand the weight of outdoor

unit.

(4) Make sure that the installation follows the requirement of installation dimension diagram.

(5) Select a location which is out of reach for children and far away from animals or plants. If it is unavoidable, please add fence for safety purpose.

8.4 Electric Connection Requirement

1. Safety Precaution

(1) Must follow the electric safety regulations when installing the unit.

(2) According to the local safety regulations, use qualified power supply circuit and air switch.

(3) Make sure the power supply matches with the requirement of air conditioner. Unstable power supply or incorrect wiring may result in electric shock, fire hazard or malfunction. Please install proper power supply cables before using the air conditioner.

(4) Properly connect the live wire, neutral wire and grounding wire of power socket.

(5) Be sure to cut off the power supply before proceeding any work related to electricity and safety.

(6) Do not put through the power before finishing installation.

(7) The temperature of refrigerant circuit will be high, please keep the interconnection cable away from the copper tube.

(8) The appliance shall be installed in accordance with national wiring regulations.

2. Grounding Requirement:

(1) The air conditioner is I class electric appliance. It must be properly grounding with specialized grounding device by a professional. Please make sure it is always grounded effectively, otherwise it may cause electric shock.

(2) The yellow-green wire in air conditioner is grounding wire, which can't be used for other purposes.

(3) The grounding resistance should comply with national electric safety regulations.

(4) The appliance must be positioned so that the plug is accessible.

(5) An all-pole disconnection switch having a contact separation of at least 3mm in all poles should be connected in fixed wiring.

(6) Including an air switch with suitable capacity. Air switch should be included magnet buckle and heating buckle function, it can protect the circuit-short and overload. (Caution: please do not use the fuse only for protect the circuit)

8.5 Installation of Indoor Unit

1. Choosing Installation location

Recommend the installation location to the client and then confirm it with the client.

2. Install Wall-mounting Frame

(1) Hang the wall-mounting frame on the wall; adjust it in horizontal position with the level meter and then point out the screw fixing holes on the wall.

(2) Drill the screw fixing holes on the wall with impact drill (the specification of drill head should be the same as the plastic expansion particle) and then fill the plastic expansion particles in

8. Installation

the holes.

(3) Fix the wall-mounting frame on the wall with tapping screws and then check if the frame is firmly installed by pulling the frame. If the plastic expansion particle is loose, please drill another fixing hole nearby.

3. Drill Piping Hole

(1) Choose the position of piping hole according to the direction of outlet pipe. The position of piping hole should be a little lower than the wall-mounted frame. (As show in Fig.1)

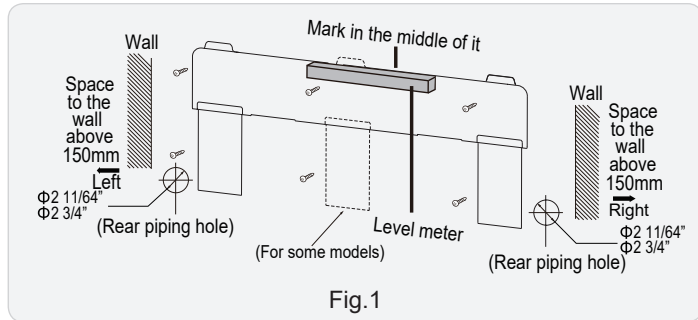

(2) Drill a piping hole with the diameter of $\Phi 2 \frac{11}{64}$ " or $\Phi 2 \frac{3}{4}$ " on the selected outlet pipe position. In order to drain smoothly, slant the piping hole on the wall slightly downward to the outdoor side with the gradient of $5-10^\circ$. (As show in Fig.2)

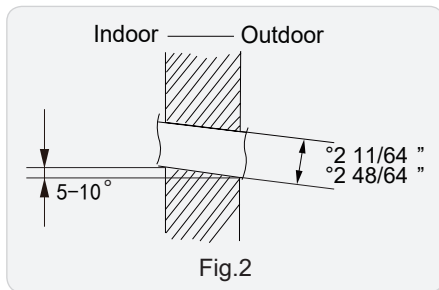

⚠ Note:

Pay attention to dust prevention and take relevant safety measures when drill the hole.

4. Outlet Pipe

(1) The pipe can be led out in the direction of right, rear right, left or rear left. (As show in Fig.3)

(2) When selecting leading out the pipe from left or right, please cut off the corresponding hole on the bottom case. (As show in Fig.4)

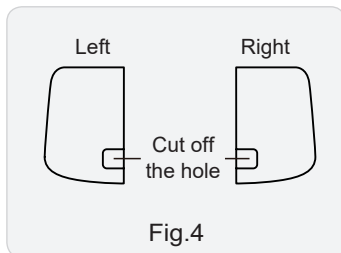
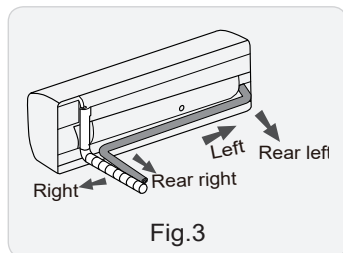

5. Connect the Pipe of Indoor Unit

(1) Aim the pipe joint at the corresponding bellmouth. (As show in Fig.5)

(2) Pretightening the union nut with hand.

(3) Adjust the torque force by referring to the following sheet. Place the open-end wrench on the pipe joint and place the

torque wrench on the union nut. Tighten the union nut with torque wrench. (As show in Fig.6)

(4) Wrap the indoor pipe and joint of connection pipe with insulating pipe, and then wrap it with tape. (As show in Fig.7)

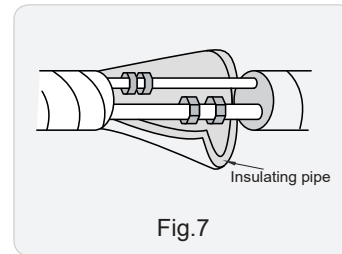
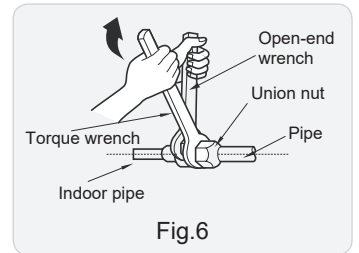
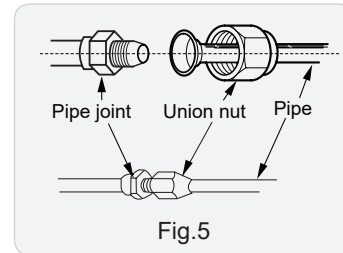

Refer to the following table for wrench moment of force:

Piping size (inch)	Tightening torque (N·m)
1/4	15~20
3/8	30~40
1/2	45~55
5/8	60~65
3/4	70~75

6. Install Drain Hose

(1) Connect the drain hose to the outlet pipe of indoor unit. (As show in Fig.8)

(2) Bind the joint with tape. (As show in Fig.9)

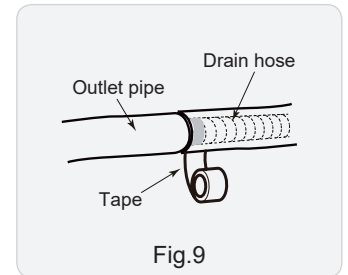
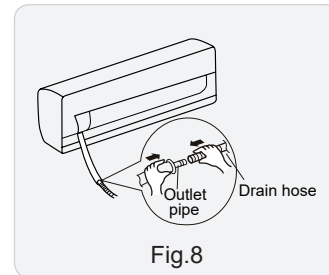

⚠ Note:

(1) Add insulating pipe in the indoor drain hose in order to prevent condensation.

(2) The plastic expansion particles are not provided. (As show in Fig.10)

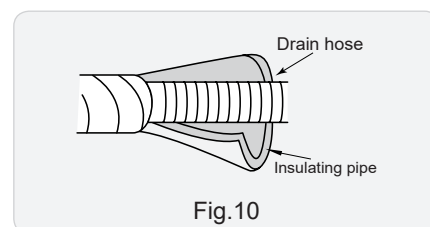

8. Installation

7. Connect Wire of Indoor Unit

(1) Open the panel, remove the screw on the wiring cover and then take down the cover. (As show in Fig.11)

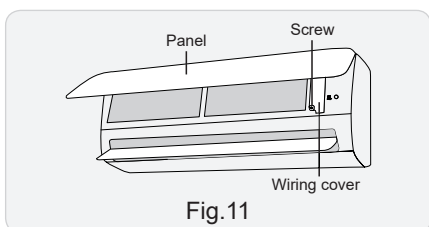

(2) Make the power connection wire go through the cable-cross hole at the back of indoor unit and then pull it out from the front side. (As show in Fig.12)

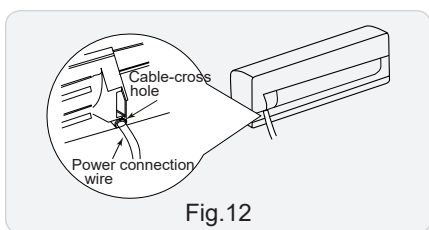

(3) Remove the wire clip; connect the power connection wiresignal control wire (only for cooling and heating unit) to the wiring terminal according to the color; tighten the screw and then fix the power connection wire with wire clip. (As show in Fig.13)

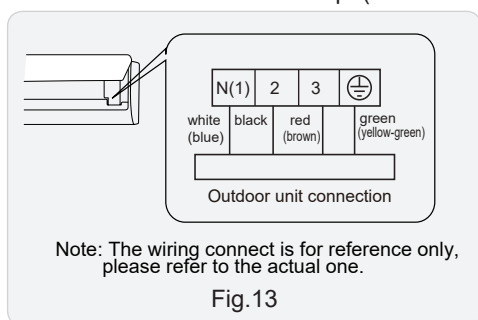

(4) Put wiring cover back and then tighten the screw.
(5) Close the panel.

⚠ Note:

- All wires of indoor unit and outdoor unit should be connected by a professional.
- If the length of power connection wire is insufficient, please contact the supplier for a new one. Avoid extending the wire by yourself.
- For the air conditioner with plug, the plug should be reachable after finishing installation.
- For the air conditioner without plug, an air switch must be installed in the line. The air switch should be all-pole parting and the contact parting distance should be more than 3mm.

8. Bind up Pipe

- Bind up the connection pipe, power cord and drain hose with the band. (As show in Fig.14)
- Reserve a certain length of drain hose and power cord for installation when binding them. When binding to a certain degree, separate the indoor power and then separate the drain hose. (As show in Fig.15)
- Bind them evenly.
- The liquid pipe and gas pipe should be bound separately at the end.

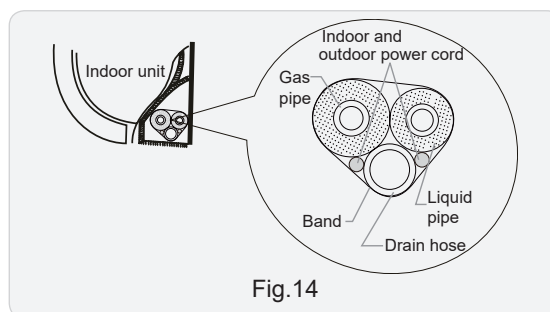

Fig.14

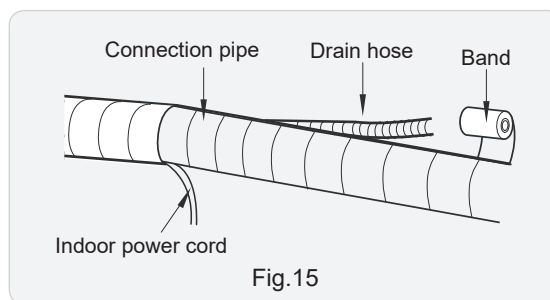

Fig.15

⚠ Note:

- The power cord and control wire can't be crossed or winding.
- The drain hose should be bound at the bottom.

9. Hang the Indoor Unit

- Put the bound pipes in the wall pipe and then make them pass through the wall hole.
- Hang the indoor unit on the wall-mounting frame.
- Stuff the gap between pipes and wall hole with sealing gum.
- Fix the wall pipe. (As show in Fig.16)
- Check if the indoor unit is installed firmly and closed to the wall. (As show in Fig.17)

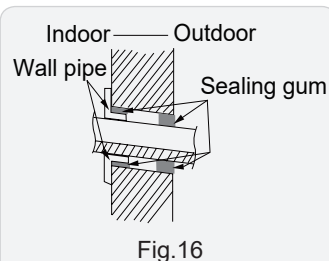

Fig.16

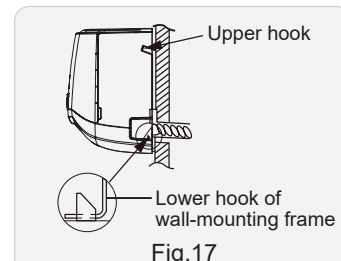

Fig.17

⚠ Note:

Do not bend the drain hose too excessively in order to prevent blocking.

8.6 Installation of Outdoor Unit

1. Fix the Support of Outdoor Unit(Select it according to the actual installation situation)

- Select installation location according to the house structure.
- Fix the support of outdoor unit on the selected location with expansion screws.

⚠ Note:

- Take sufficient protective measures when installing the outdoor unit.
- Make sure the support can withstand at least four times the unit weight.
- The outdoor unit should be installed at least 3cm above the floor in order to install drain joint.(As show in Fig.18)

8. Installation

(4) For the unit with cooling capacity of 2300W~5000W, 6 expansion screws are needed; for the unit with cooling capacity of 6000W~8000W, 8 expansion screws are needed; for the unit with cooling capacity of 10000W~16000W, 10 expansion screws are needed.

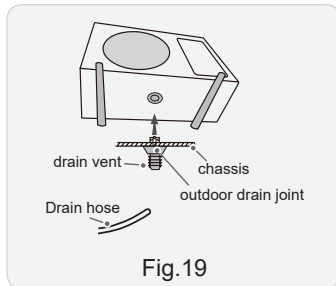
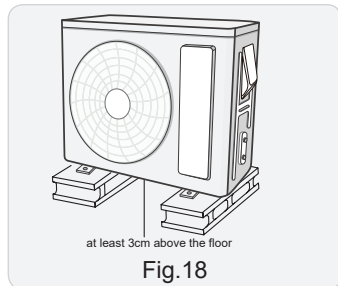

2. Install Drain Joint(Only for cooling and heating unit)

- (1) Connect the outdoor drain joint into the hole on the chassis.
- (2) Connect the drain hose into the drain vent.(As show in Fig.19)

3. Fix Outdoor Unit

- (1) Place the outdoor unit on the support.
- (2) Fix the foot holes of outdoor unit with bolts.(As show in Fig.20)

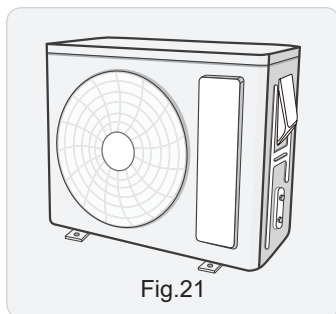
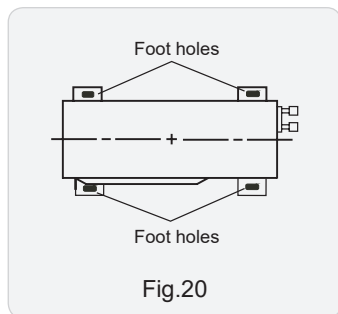

4. Connect Indoor and Outdoor Pipes

- (1) Remove the screw on the right handle of outdoor unit and then remove the handle. (As show in Fig.21)
- (2) Remove the screw cap of valve and aim the pipe joint at the bellmouth of pipe. (As show in Fig.22)

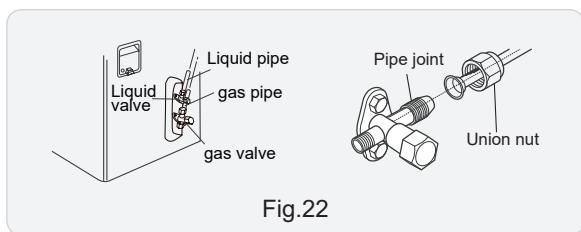

- (3) Pretightening the union nut with hand.
 - (4) Tighten the union nut with torque wrench .
- Refer to the following table for wrench moment of force :

Piping size (inch)	Tightening torque (N·m)
1/4	15~20
3/8	30~40
1/2	45~55
5/8	60~65
3/4	70~75

5. Connect Outdoor Electric Wire

For model:
4LIV30HP230V1AO 4LIV36HP230V1AO

- (1) Remove the wire clip; connect the power connection wire and signal control wire (only for cooling and heating unit) to the wiring terminal according to the color; fix them with screws. (As show in Fig.23)

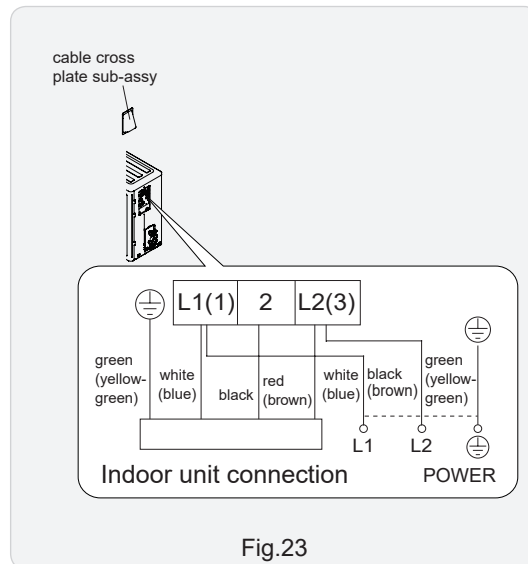

Note:
The wiring connect is for reference only, please refer to the actual one.

- (2) Fix the power connection wire and signal control wire with wire clip (only for cooling and heating unit).

Note:
(1) After tighten the screw, pull the power cord slightly to check if it is firm.
(2) Never cut the power connection wire to prolong or shorten the distance.

8. Installation

the wiring according to the following diagram, and ensure that the conductors connected to the "2" and "3" position of the wiring board are diagonally positioned in the cable. Otherwise, the machine may call communication error to lead the machine can't work.

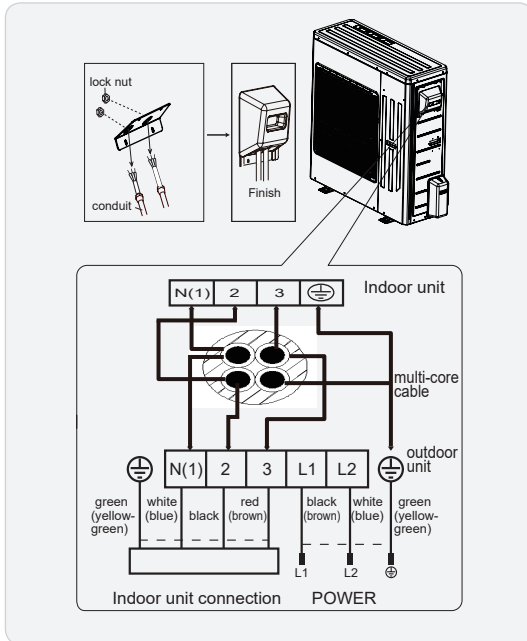

6. Fix the power connection wire and signal control wire with wire clip (only for cooling and heating unit).

⚠ Note:

- (1) After tighten the screw, pull the power cord slightly to check if it is firm.
- (2) Never cut the power connection wire to prolong or shorten the distance.

6. Neaten the Pipes

- (1) The pipes should be placed along the wall, bent reasonably and hidden possibly. Min. semidiameter of bending the pipe is 10cm.
- (2) If the outdoor unit is higher than the wall hole, you must set a U-shaped curve in the pipe before pipe goes into the room, in order to prevent rain from getting into the room. (As show in Fig.24)

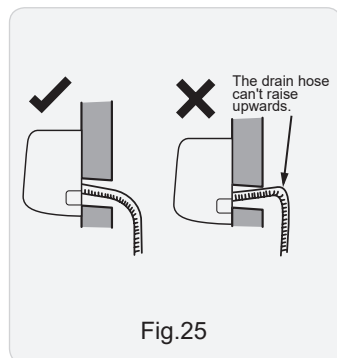
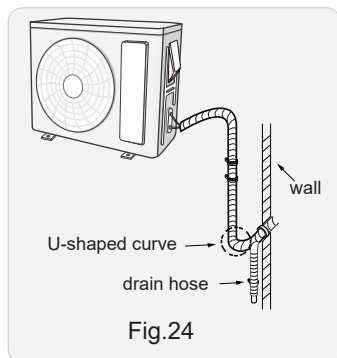

⚠ Note:

- (1) The through-wall height of drain hose shouldnt be higher than the outlet pipe hole of indoor unit.(As show in Fig.25)
- (2) Slant the drain hose slightly downwards. The drain hose can't be curved, raised and fluctuant, etc.(As show in Fig.26)
- (3) The water outlet can't be placed in water in order to drain smoothly.(As show in Fig.27)

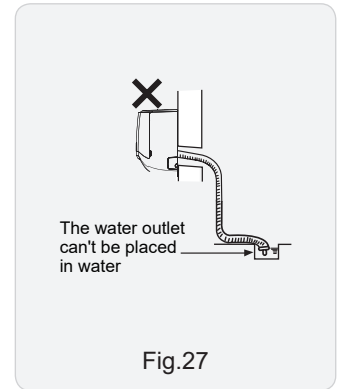
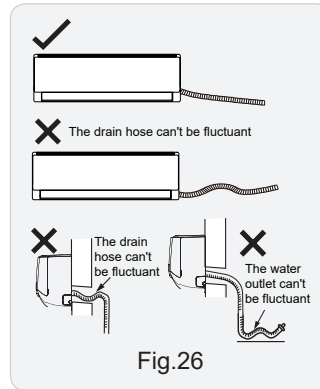

8.7 Vacuum Pumping and Leak Detection

1. Use Vacuum Pump

- (1) Remove the valve caps on the liquid valve and gas valve and the nut of refrigerant charging vent.
- (2) Connect the charging hose of piezometer to the refrigerant charging vent of gas valve and then connect the other charging hose to the vacuum pump.
- (3) Open the piezometer completely and operate for 10-15min to check if the pressure of piezometer remains in -0.1MPa.
- (4) Close the vacuum pump and maintain this status for 1-2min to check if the pressure of piezometer remains in -0.1MPa. If the pressure decreases, there may be leakage.
- (5) Remove the piezometer, open the valve core of liquid valve and gas valve completely with inner hexagon spanner.
- (6) Tighten the screw caps of valves and refrigerant charging vent.(As show in Fig.28)
- (7) Reinstall the handle.

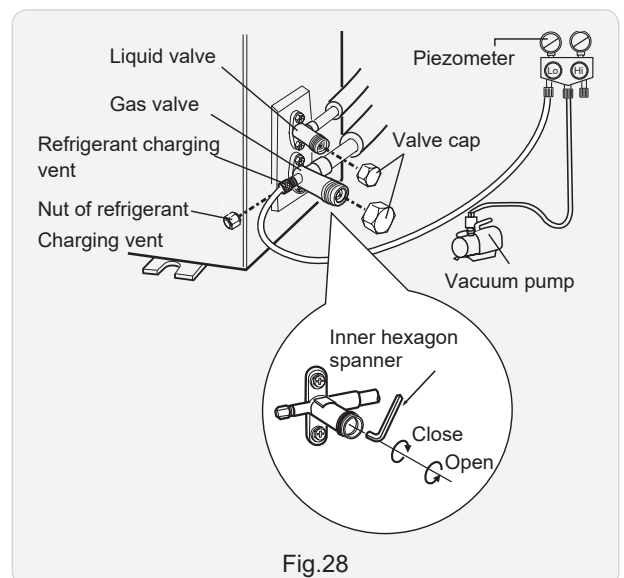

8. Installation

2. Leakage Detection

(1) With leakage detector:

Check if there is leakage with leakage detector.

(2) With soap water:

If leakage detector is not available, please use soap water for leakage detection. Apply soap water at the suspected position and keep the soap water for more than 3min. If there are air bubbles coming out of this position, There's a leakage.

8.8 Check after Installation and Test Operation

1. Check after Installation

Check according to the following requirement after finishing installation.

NO.	Items to be checked	Possible malfunction
1	Has the unit been installed firmly?	The unit may drop, shake or emit noise.
2	Have you done the refrigerant leakage test?	It may cause insufficient cooling (heating) capacity.
3	Is heat insulation of pipeline sufficient?	It may cause condensation and water dripping.
4	Is water drained well?	It may cause condensation and water dripping.
5	Is the voltage of power supply according to the voltage marked on the nameplate?	It may cause malfunction or damage the parts.
6	Is electric wiring and pipeline installed correctly?	It may cause malfunction or damage the parts.
7	Is the unit grounded securely?	It may cause electric leakage.
8	Does the power cord follow the specification?	It may cause malfunction or damage the parts.
9	Is there any obstruction in air inlet and air outlet?	It may cause insufficient cooling (heating) capacity.
10	The dust and sundries caused during installation are removed?	It may cause malfunction or damaging the parts.
11	The gas valve and liquid valve of connection pipe are open completely?	It may cause insufficient cooling (heating) capacity.
12	Is the inlet and outlet of piping hole been covered?	It may cause insufficient cooling(heating) capacity or waster eletricity.

2. Test Operation

(1) Preparation of test operation

- The client approves the air conditioner installation.
- Specify the important notes for air conditioner to the client.

(2) Method of test operation

- Put through the power, press ON/OFF button on the remote controller to start operation.
- Press MODE button to select AUTO, COOL, DRY, FAN and HEAT to check whether the operation is normal or not.
- If the ambient temperature is lower than 16°C , the air conditioner can't start cooling.

9. Maintenance

9.1 Error Code List

No.	Malfunction Name	Display Method of Indoor Unit	A/C status	Possible Causes
		Dual-8 Code Display		
1	High pressure protection of system	E1	During cooling and drying operation, except indoor fan operates, all loads stop operation. During heating operation, the complete unit stops.	Possible reasons: 1. Refrigerant was superabundant; 2. Poor heat exchange (including filth blockage of heat exchanger and bad radiating environment); Ambient temperature is too high.
2	Low pressure protection of system	E3	The Dual-8 Code Display will show E3 until the low pressure switch stop operation.	1.Low-pressure protection 2.Low-pressure protection of system 3.Low-pressure protection of compressor
3	High discharge temperature protection of compressor	E4	During cooling and drying operation, compressor and outdoor fan stop while indoor fan operates. During heating operation, all loads stop.	Please refer to the malfunction analysis (discharge protection, overload).
4	Overcurrent protection	E5	During cooling and drying operation, compressor and outdoor fan stop while indoor fan operates. During heating operation, all loads stop.	1. Supply voltage is unstable; 2. Supply voltage is too low and load is too high; 3. Evaporator is dirty.
5	Communication Malfunction	E6	During cooling operation,compressor stops while indoor fan motor operates. During heating operation, the complete unit stops.	Refer to the corresponding malfunction analysis.
6	High temperature resistant protection	E8	During cooling operation: compressor will stop while indoor fan will operate. During heating operation, the complete unit stops.	Refer to the malfunction analysis (overload, high temperature resistant).
7	EEPROM malfunction	EE	During cooling and drying operation, compressor will stop while indoor fan will operate; During heating operation, the complete unit will stop	Replace outdoor control panel AP1
8	Limit/decrease frequency due to high temperature of module	EU	All loads operate normally, while operation frequency for compressor is decreased	Discharging after the complete unit is de-energized for 20mins, check whether the thermal grease on IPM Module of outdoor control panel AP1 is sufficient and whether the radiator is inserted tightly. If it's no use, please replace control panel AP1.
9	Malfunction protection of jumper cap	C5	Wireless remote receiver and button are effective, but can not dispose the related command	1. No jumper cap insert on mainboard. 2. Incorrect insert of jumper cap. 3. Jumper cap damaged. 4. Abnormal detecting circuit of mainboard.
10	Refrigerant insufficient protection, cut off protection of refrigerant	F0	Cool: compressor and outdoor fan stops operation, while indoor fan operates; Heat: Compressor, outdoor fan and indoor fan stops operation.	1. Is system cooling under high humidity environment, thus temperature difference of heat transfer is small; 2. Check whether the big valve and small valve of outdoor unit are opened completely; 3. Is the temperature sensor of evaporator of indoor unit loose? 4. Is the temperature sensor of condenser of outdoor unit loose? 5. Is the capillary or the electronic expansion valve blocked? 6. Is refrigerant leaking?
11	Indoor ambient temperature sensor is open/short circuited	F1	During cooling and drying operation, indoor unit operates while other loads will stop; during heating operation, the complete unit will stop operation.	1. Loosening or bad contact of indoor ambient temp. sensor and mainboard terminal. 2. Components in mainboard fell down leads short circuit. 3. Indoor ambient temp. sensor damaged.(check with sensor resistance value chart) 4. Mainboard damaged.
12	Indoor evaporator temperature sensor is open/short circuited	F2	AC stops operation once reaches the setting temperature. Cooling, drying: internal fan motor stops operation while other loads stop operation; heating: AC stop operation	1. Loosening or bad contact of Indoor evaporator temp. sensor and mainboard terminal. 2. Components on the mainboard fall down leads short circuit. 3. Indoor evaporator temp. sensor damaged. (check temp. sensor value chart for testing) 4. Mainboard damaged.
13	Outdoor ambient temperature sensor is open/short circuited	F3	During cooling and drying operating, compressor stops while indoor fan operates; During heating operation, the complete unit will stop operation	Outdoor temperature sensor hasn't been connected well or is damaged. Please check it by referring to the resistance table for temperature sensor)

9. Maintenance

No.	Malfunction Name	Display Method of Indoor Unit	A/C status	Possible Causes
		Dual-8 Code Display		
14	Outdoor condenser temperature sensor is open/short circuited	F4	During cooling and drying operation, compressor stops while indoor fan will operate; During heating operation, the complete unit will stop operation.	Outdoor temperature sensor hasn't been connected well or is damaged. Please check it by referring to the resistance table for temperature sensor)
16	Outdoor discharge temperature sensor is open/short circuited	F5	During cooling and drying operation, compressor will stop after operating for about 3 mins, while indoor fan will operate; During heating operation, the complete unit will stop after operating for about 3 mins.	1.Outdoor temperature sensor hasn't been connected well or is damaged. Please check it by referring to the resistance table for temperature sensor) 2.The head of temperature sensor hasn't been inserted into the copper tube
17	Limit/decrease frequency due to overload	F6	All loads operate normally, while operation frequency for compressor is decreased	Refer to the malfunction analysis (overload, high temperature resistant)
18	Decrease frequency due to overcurrent	F8	All loads operate normally, while operation frequency for compressor is decreased	The input supply voltage is too low; System pressure is too high and overload
19	Decrease frequency due to high air discharge	F9	All loads operate normally, while operation frequency for compressor is decreased	Overload or temperature is too high; Refrigerant is insufficient; Malfunction of electric expansion valve (EKV)
20	Limit/decrease frequency due to antifreezing	FH	All loads operate normally, while operation frequency for compressor is decreased	Poor air-return in indoor unit or fan speed is too low
21	Voltage for DC bus-bar is too high	PH	During cooling and drying operation, compressor will stop while indoor fan will operate; During heating operation, the complete unit will stop operation.	1. Measure the voltage of position L and N on wiring board (XT), if the voltage is higher than 265VAC, turn on the unit after the supply voltage is increased to the normal range. 2.If the AC input is normal, measure the voltage of electrolytic capacitor C on control panel (AP1), if it's normal, There's malfunction for the circuit, please replace the control panel (AP1)
22	Voltage of DC bus-bar is too low	PL	During cooling and drying operation, compressor will stop while indoor fan will operate; During heating operation, the complete unit will stop	1. Measure the voltage of position L and N on wiring board (XT), if the voltage is higher than 150VAC, turn on the unit after the supply voltage is increased to the normal range. 2.If the AC input is normal, measure the voltage of electrolytic capacitor C on control panel (AP1), if it's normal, There's malfunction for the circuit, please replace the control panel (AP1)
23	Compressor Min frequency in test state	P0		Showing during min. cooling or min. heating test
24	Compressor rated frequency in test state	P1		Showing during nominal cooling or nominal heating test
25	Compressor maximum frequency in test state	P2		Showing during max. cooling or max. heating test
26	Compressor intermediate frequency in test state	P3		Showing during middle cooling or middle heating test
27	Overcurrent protection of phase current for compressor	P5	During cooling and drying operation, compressor will stop while indoor fan will operate; During heating operation, the complete unit will stop operation.	Refer to the malfunction analysis (IPM protection, loss of synchronism protection and overcurrent protection of phase current for compressor.
28	Charging malfunction of capacitor	PU	During cooling and drying operation, compressor will stop while indoor fan will operate; During heating operation, the complete unit will stop	Refer to the part three—charging malfunction analysis of capacitor

9. Maintenance

No.	Malfunction Name	Display Method of Indoor Unit	A/C status	Possible Causes
		Dual-8 Code Display		
29	Malfunction of module temperature sensor circuit	P7	During cooling and drying operation, compressor will stop while indoor fan will operate; During heating operation, the complete unit will stop	Replace outdoor control panel AP1
30	Module high temperature protection	P8	During cooling operation, compressor will stop while indoor fan will operate; During heating operation, the complete unit will stop	After the complete unit is de-energized for 20mins, check whether the thermal grease on IPM Module of outdoor control panel AP1 is sufficient and whether the radiator is inserted tightly. If it's no use, please replace control panel AP1.
31	Overload protection for compressor	H3	During cooling and drying operation, compressor will stop while indoor fan will operate; During heating operation, the complete unit will stop operation.	1. Wiring terminal OVC-COMP is loosened. In normal state, the resistance for this terminal should be less than 1ohm. 2. Refer to the malfunction analysis (discharge protection, overload)
32	IPM protection	H5	During cooling and drying operation, compressor will stop while indoor fan will operate; During heating operation, the complete unit will stop operation.	Refer to the malfunction analysis (IPM protection, loss of synchronism protection and overcurrent protection of phase current for compressor.
33	Module temperature is too high	P8	During cooling and drying operation, compressor and outdoor fan stop while indoor fan operates. During heating operation, all loads stop.	Radiating grease on IPM module of outdoor unit main board is not enough; screws have not been fixed tightly; Hardware malfunction of outdoor unit main board;
34	Internal motor (fan motor) do not operate	H6	Internal fan motor, external fan motor, compressor and electric heater stop operation,guide louver stops at present location.	1. Bad contact of DC motor feedback terminal. 2. Bad contact of DC motor control end. 3. Fan motor is stalling. 4. Motor malfunction. 5. Malfunction of mainboard revdetecting circuit.
35	Desynchro-nizing of compressor	H7	During cooling and drying operation, compressor will stop while indoor fan will operate; During heating operation, the complete unit will stop operation.	Refer to the malfunction analysis (IPM protection, loss of synchronism protection and overcurrent protection of phase current for compressor.
36	Outdoor DC fan motor malfunction	L3	Outdoor DC fan motor malfunction lead to compressor stop operation,	DC fan motor malfunction or system blocked or the connector loosed
37	power protection	L9	compressor stop operation and Outdoor fan motor will stop 30s latter , 3 minutes latter fan motor and compressor will restart	To protect the electronical components when detect high power
38	Indoor unit and outdoor unit doesn't match	LP	compressor and Outdoor fan motor can't work	Indoor unit and outdoor unit doesn't match
39	Failure start-up	LC	During cooling and drying operation, compressor will stop while indoor fan will operate; During heating operation, the complete unit will stop operation.	Refer to the malfunction analysis
40	Cold air prevention protection	E9		Not the error code. It's the status code for the operation.
41	Anti-freezing rotection for evaporator	E2		Not the error code. It's the status code for the operation.
42	Malfunction of phase current detection circuit for compressor	U1	During cooling and drying operation, compressor will stop while indoor fan will operate; During heating operation, the complete unit will stop	Replace outdoor control panel AP1

9. Maintenance

No.	Malfunction Name	Display Method of Indoor Unit	A/C status	Possible Causes
		Dual-8 Code Display		
43	Malfunction of voltage dropping for DC bus-bar	U3	During cooling and drying operation, compressor will stop while indoor fan will operate; During heating operation, the complete unit will stop	Supply voltage is unstable
44	Malfunction of complete unit's current detection	U5	During cooling and drying operation, the compressor will stop while indoor fan will operate; During heating operating, the complete unit will stop operation.	There's circuit malfunction on outdoor unit control panel AP1, please replace the outdoor unit control panel AP1.
45	The four-way valve is abnormal	U7	If this malfunction occurs during heating operation, the complete unit will stop operation.	1. Supply voltage is lower than AC175V; 2. Wiring terminal 4V is loosened or broken; 3. 4V is damaged, please replace 4V.
46	Malfunction of zero-cross detection circuit	U8	The complete unit stops	1. Power supply is abnormal; 2. Detection circuit of indoor control mainboard is abnormal.
47	Malfunction of detecting plate(WIFI)	JF	Loads operate normally, while the unit can't be normally controlled by APP.	1. Main board of indoor unit is damaged; 2. Detection board is damaged; 3. The connection between indoor unit and detection board is not good;
48	Refrigerant recovery mode	Fo		Refrigerant recovery. The Serviceman operates it for maintenance.
49	Undefined outdoor unit error	oE	Cool: compressor and outdoor fan stops operation, while indoor fan operates; Heat: compressor, outdoor fan and indoor fan stop operation.	1. Outdoor ambient temperature exceeds the operation range of unit (eg: less than -20°C or more than 60°C for cooling; more than 30°C for heating); 2. Failure startup of compressor? 3. Are wires of compressor not connected tightly? 4. Is compressor damaged? 5. Is main board damaged?

9. Maintenance

Analysis or processing of some of the malfunction display:

1. Compressor discharge protection

Possible causes: shortage of refrigerant; blockage of air filter; poor ventilation or air flow short pass for condenser; the system has noncondensing gas (such as air, water etc.); blockage of capillary assy (including filter); leakage inside four-way valve causes incorrect operation; malfunction of compressor; malfunction of protection relay; malfunction of discharge sensor; outdoor temperature too high.

Processing method: refer to the malfunction analysis in the above section.

2. Low voltage overcurrent protection

Possible cause: Sudden drop of supply voltage.

3. Communication malfunction

Processing method: Check if communication signal cable is connected reliably.

4. Sensor open or short circuit

Processing method: Check whether sensor is normal, connected with the corresponding position on the controller and if damage of lead wire is found.

5. Compressor over load protection

Possible causes: insufficient or too much refrigerant; blockage of capillary and increase of suction temp.; improper running of compressor, burning in or stuck of bearing, damage of discharge valve; malfunction of protector.

Processing method: adjust refrigerant amount; replace the capillary; replace the compressor; use universal meter to check if the contactor of compressor is fine when it is not overheated, if not replace the protector.

6. System malfunction

ie overload protection. When tube temperature (Check the temperature of outdoor heat exchanger when cooling and check the temperature of indoor heat exchanger when heating) is too high, protection will be activated.

Possible causes: Outdoor temperature is too high when cooling; insufficient outdoor air circulation; refrigerant flow malfunction.

please refer to the malfunction analysis in the previous section for handling method .

7. IPM module protection

Processing method: Once the module malfunction happens, if it persists for a long time and can not be self-canceled, cut off the power and turn off the unit, and then re-energize the unit again after about 10 min. After repeating the procedure for several times, if the malfunction still exists, replace the module.

9. Maintenance

9.2 Procedure of Troubleshooting

• Indoor unit:

1. Malfunction of Temperature Sensor F1, F2

Main detection points:

- Is the wiring terminal between the temperature sensor and the controller loosened or poorly contacted?
- Is there short circuit due to trip-over of the parts?
- Is the temperature sensor broken?
- Is mainboard broken?

Malfunction diagnosis process:

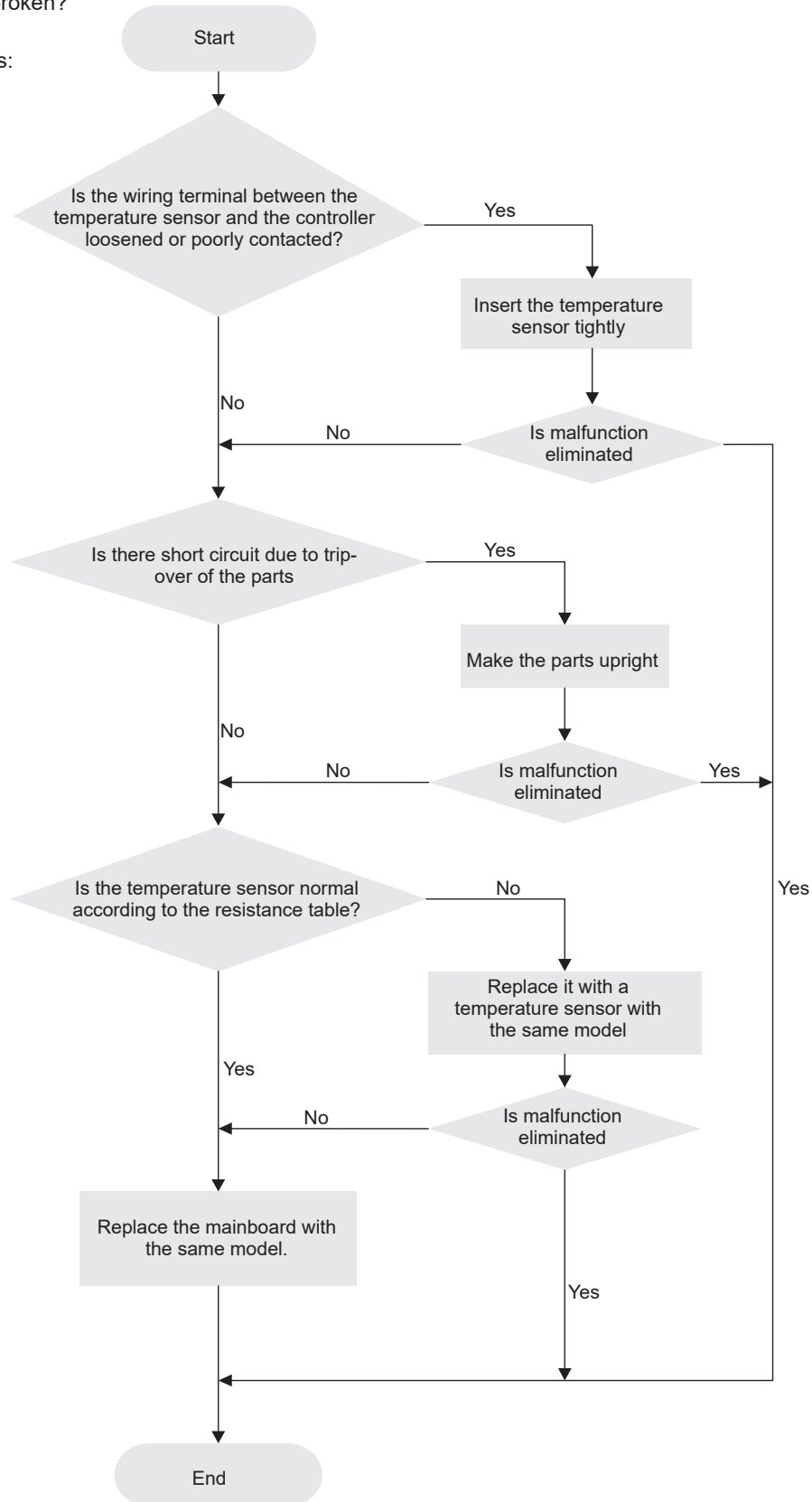

9. Maintenance

2. Malfunction of Blocked Protection of IDU Fan Motor H6

Main detection points:

- Smoothly is the control terminal of PG motor connected tightly?
- Smoothly is the feedback interface of PG motor connected tightly?
- The fan motor can't operate?
- The motor is broken?
- Detection circuit of the mainboard is defined abnormal?

Malfunction diagnosis process:

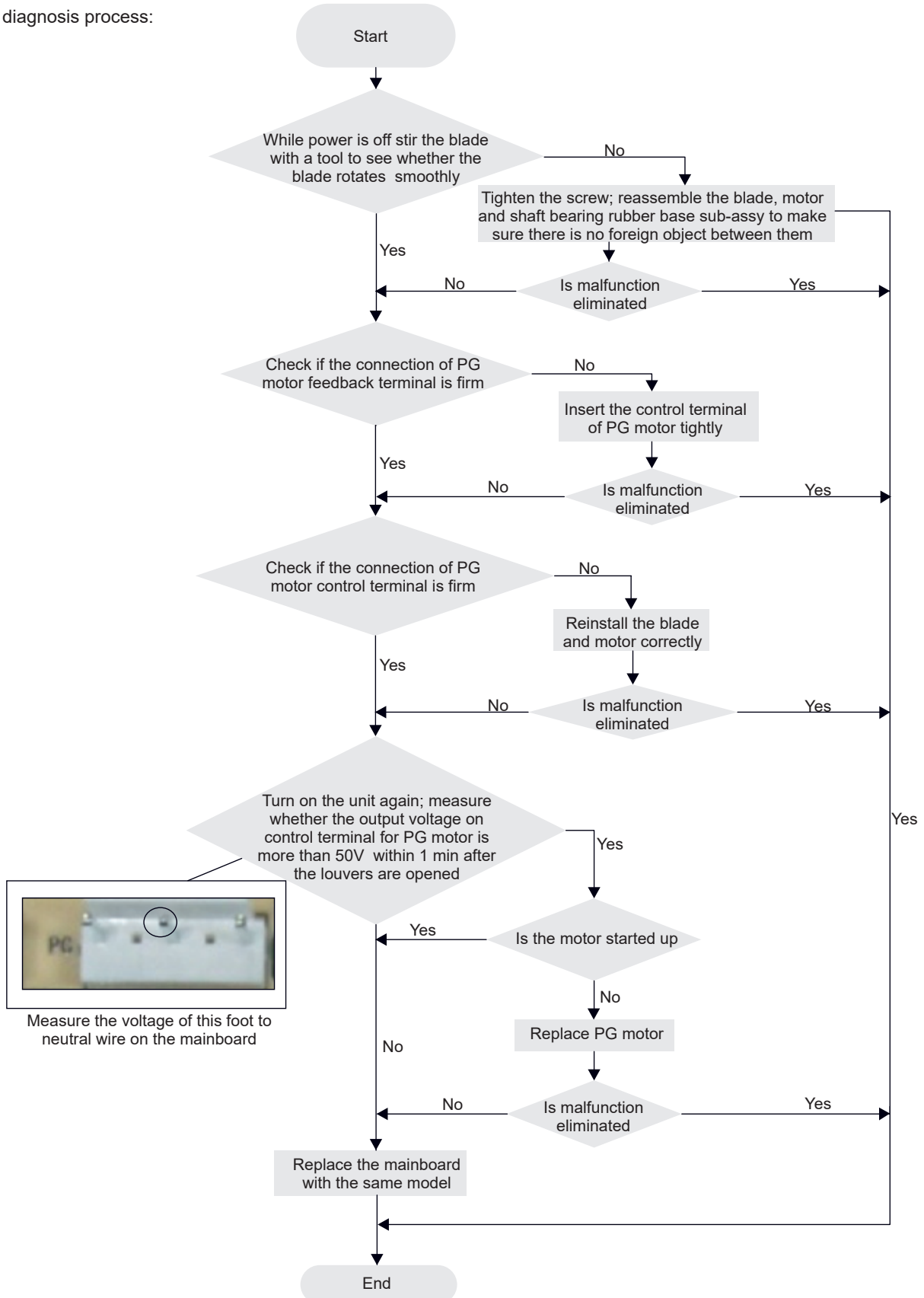

9. Maintenance

4. Malfunction of Zero-crossing Inspection Circuit Malfunction of the IDU Fan Motor U8

Main detection points:

- Instant energization after de-energization while the capacitor discharges slowly?
- The zero-cross detection circuit of the mainboard is defined abnormal?

Malfunction diagnosis process:

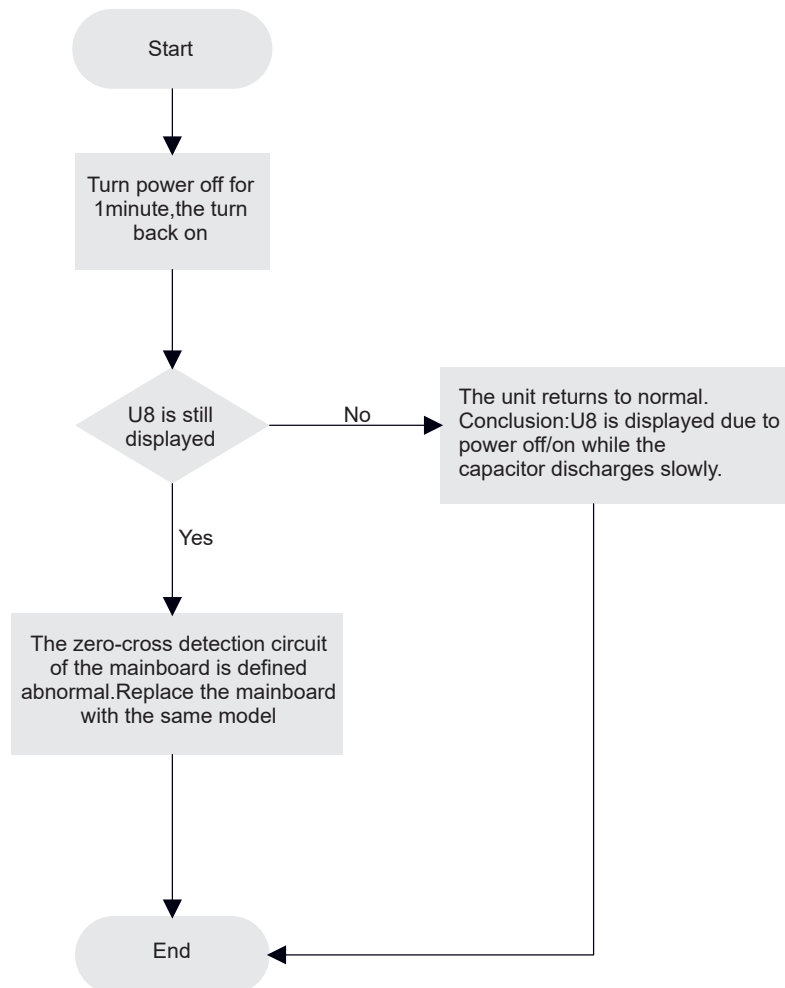

9. Maintenance

6. Malfunction of Insufficient fluorine protection F0

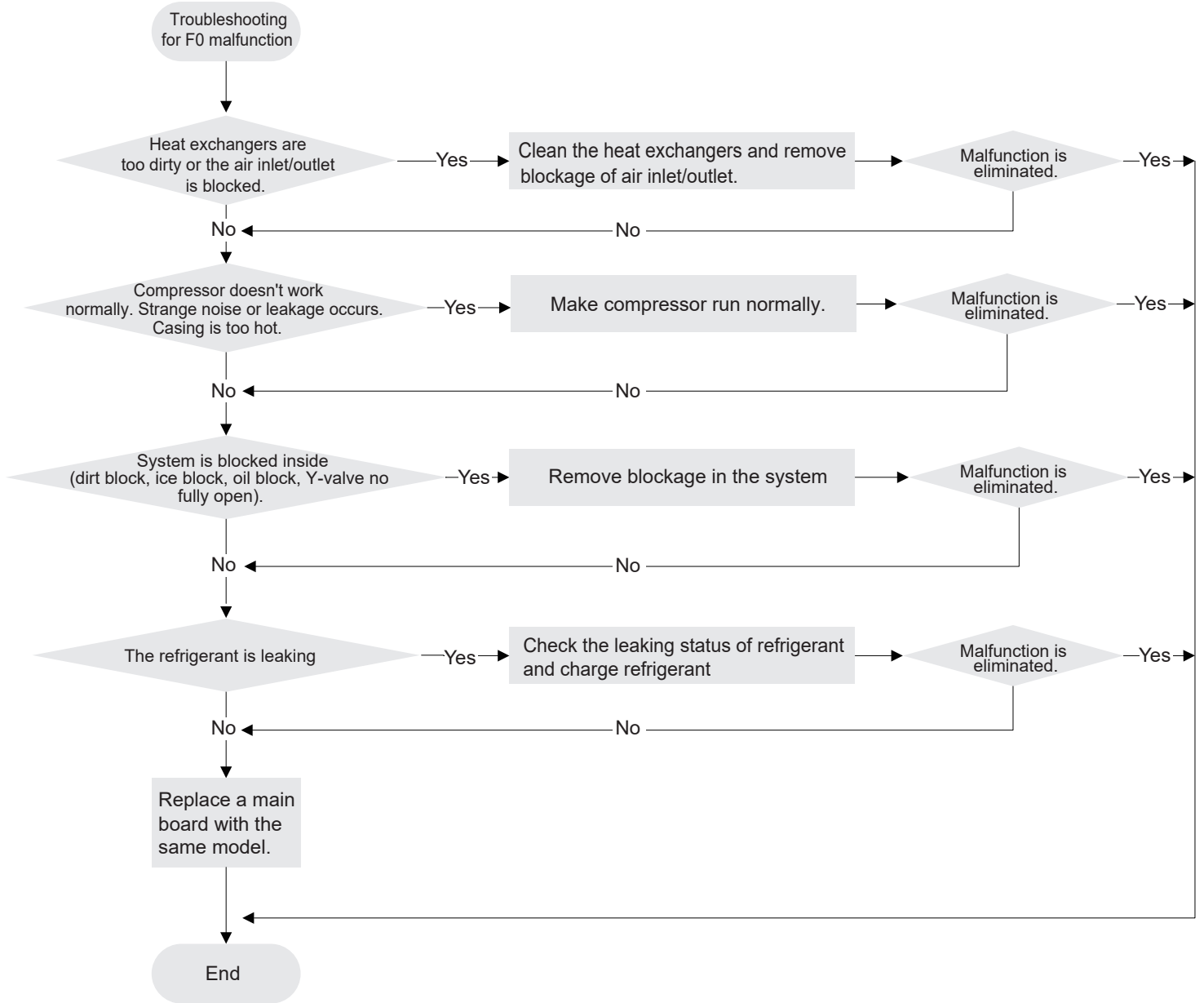

9. Maintenance

8. Malfunction of Overcurrent Protection E5

Main detection points:

- Is the supply voltage unstable with big fluctuation?
- Is the supply voltage too low with overload?
- Hardware trouble?

Malfunction diagnosis process:

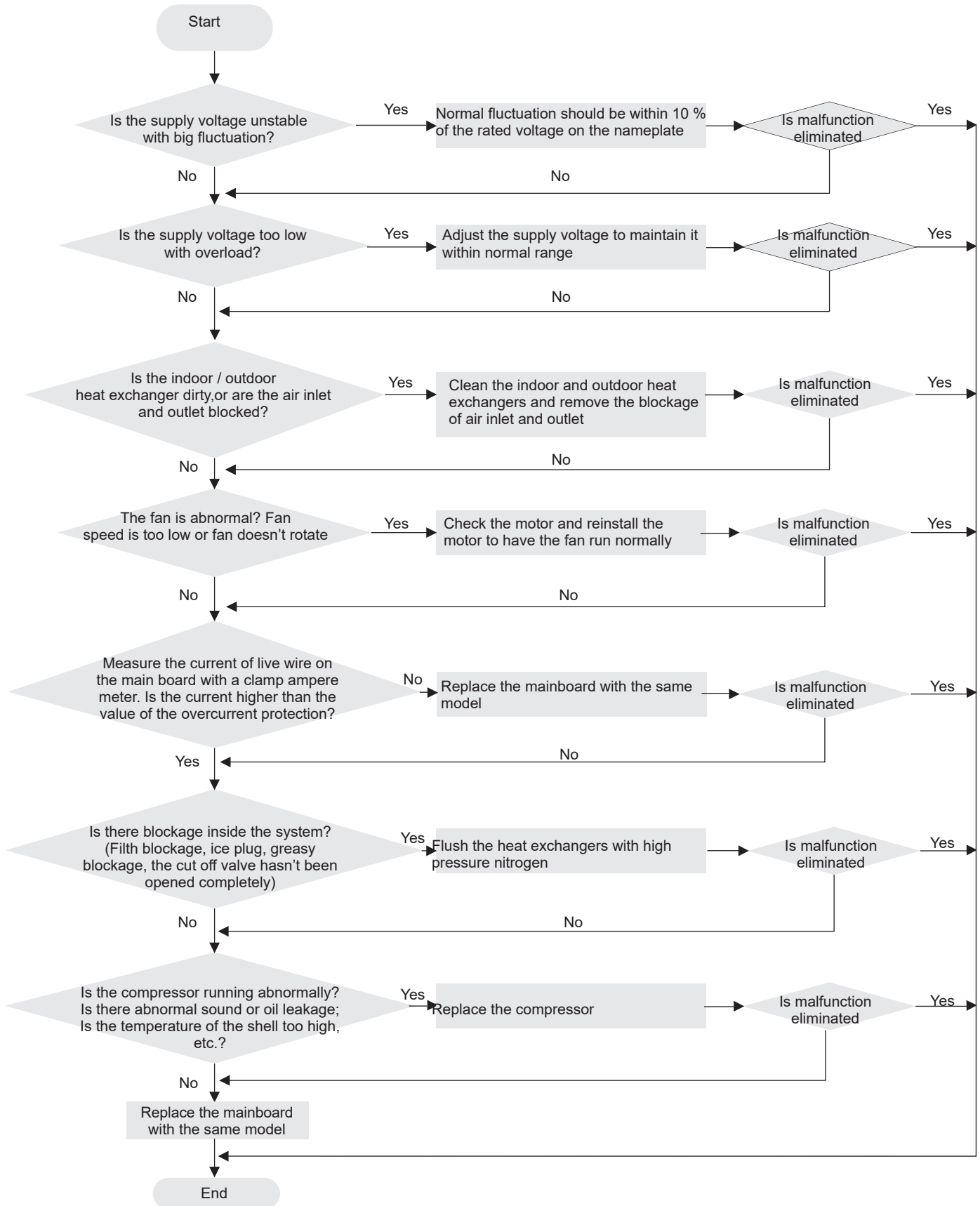

9. Maintenance

2. IPM protection H5 , over-phase current of compressor P5

(AP1 hereinafter refers to the control board of the outdoor unit)

Main detection points:

(1) compressor COMP terminal (2) power supply voltage (3) compressor (4) charging amount of refrigerant (5) air inlet and air outlet of indoor/outdoor unit

Malfunction diagnosis process:

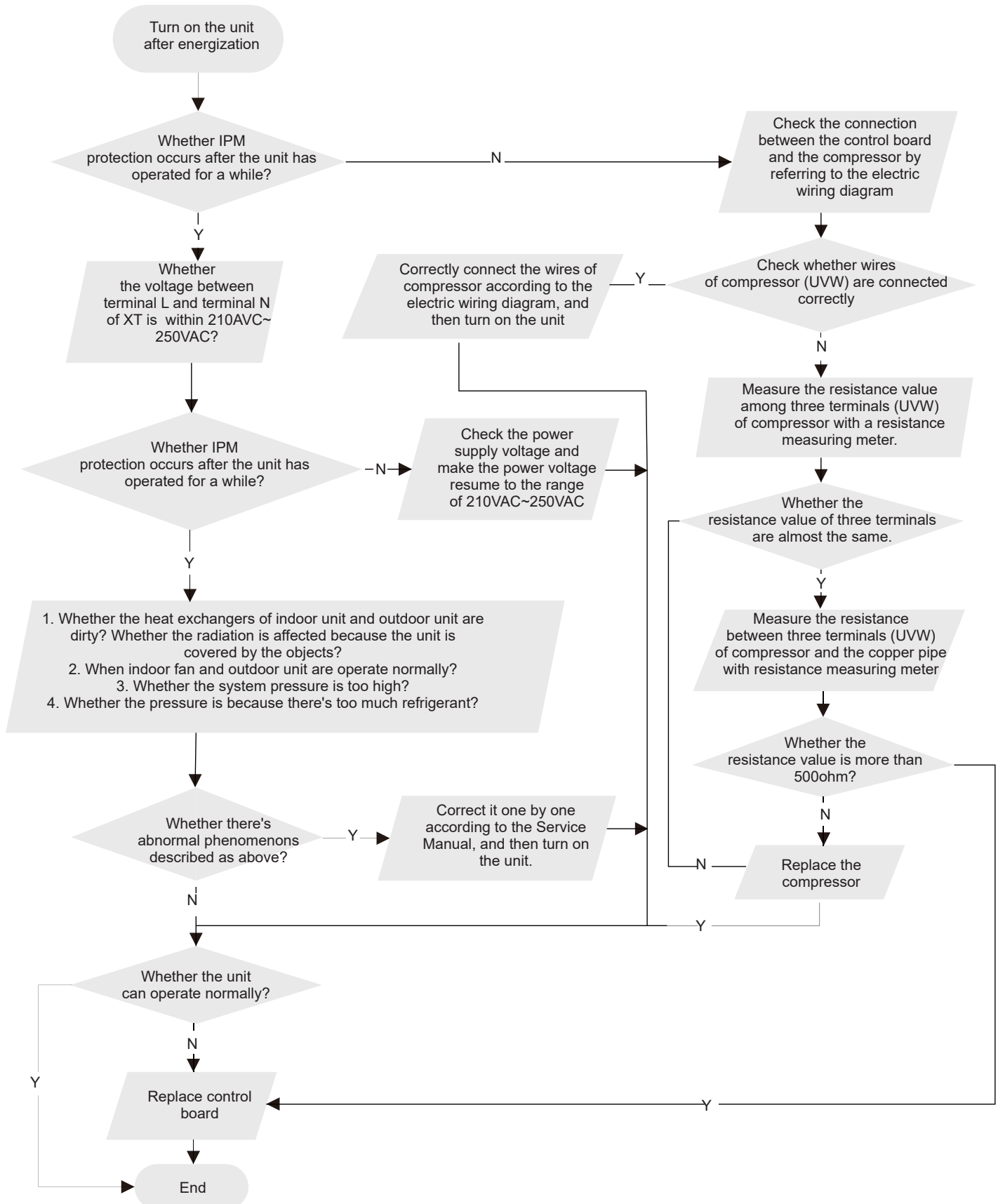

9. Maintenance

4. Start-up failure LC (following AP1 for outdoor unit control board)

Main detection points:

(1) compressor wire (2) compressor (3) charging amount of refrigerant

Malfunction diagnosis process:

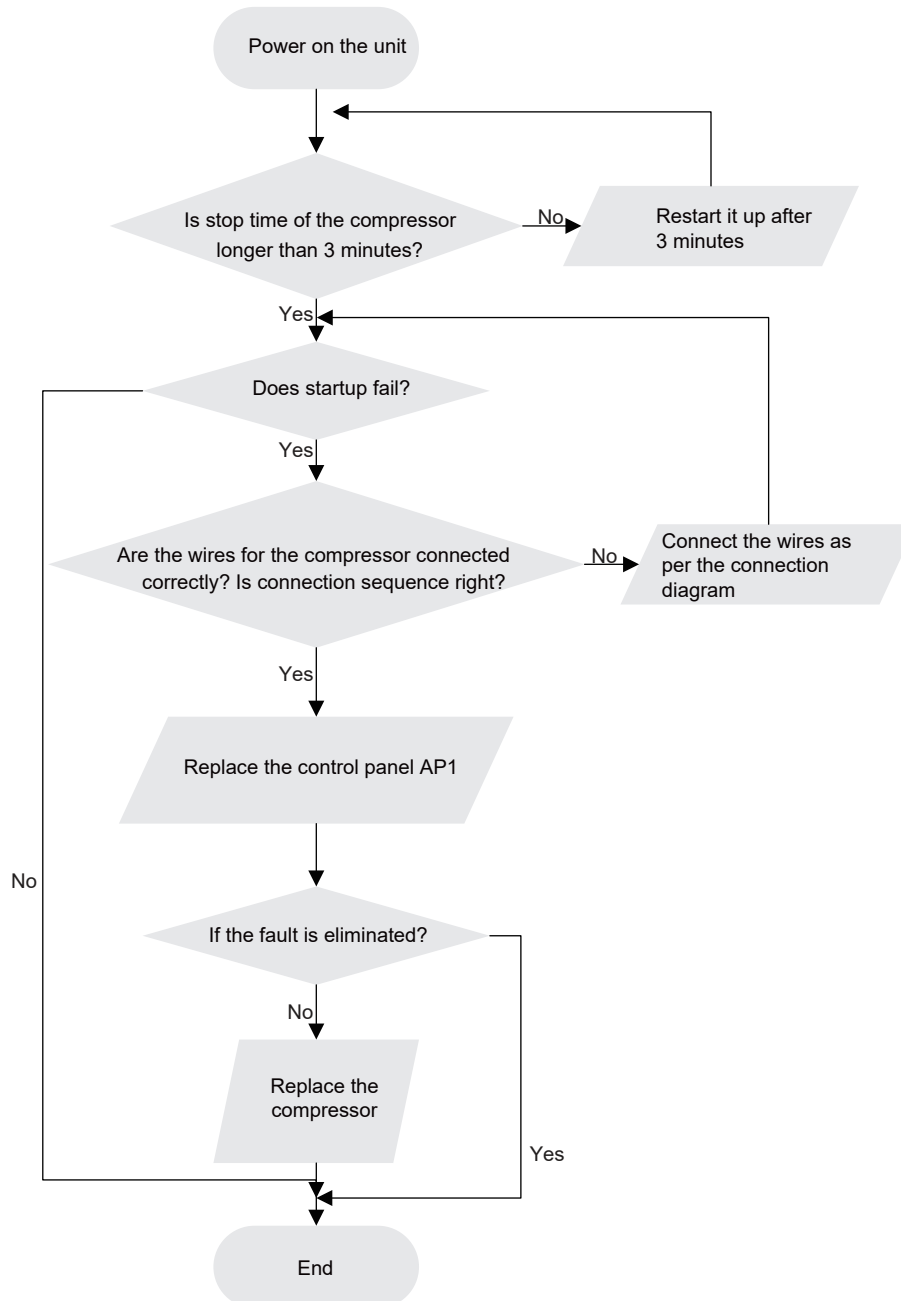

9. Maintenance

5. Desynchronization diagnosis for compressor H7

(AP1 hereinafter refers to the control board of the outdoor unit)

Main detection points:

(1) system pressure (2) power supply voltage

Malfunction diagnosis process:

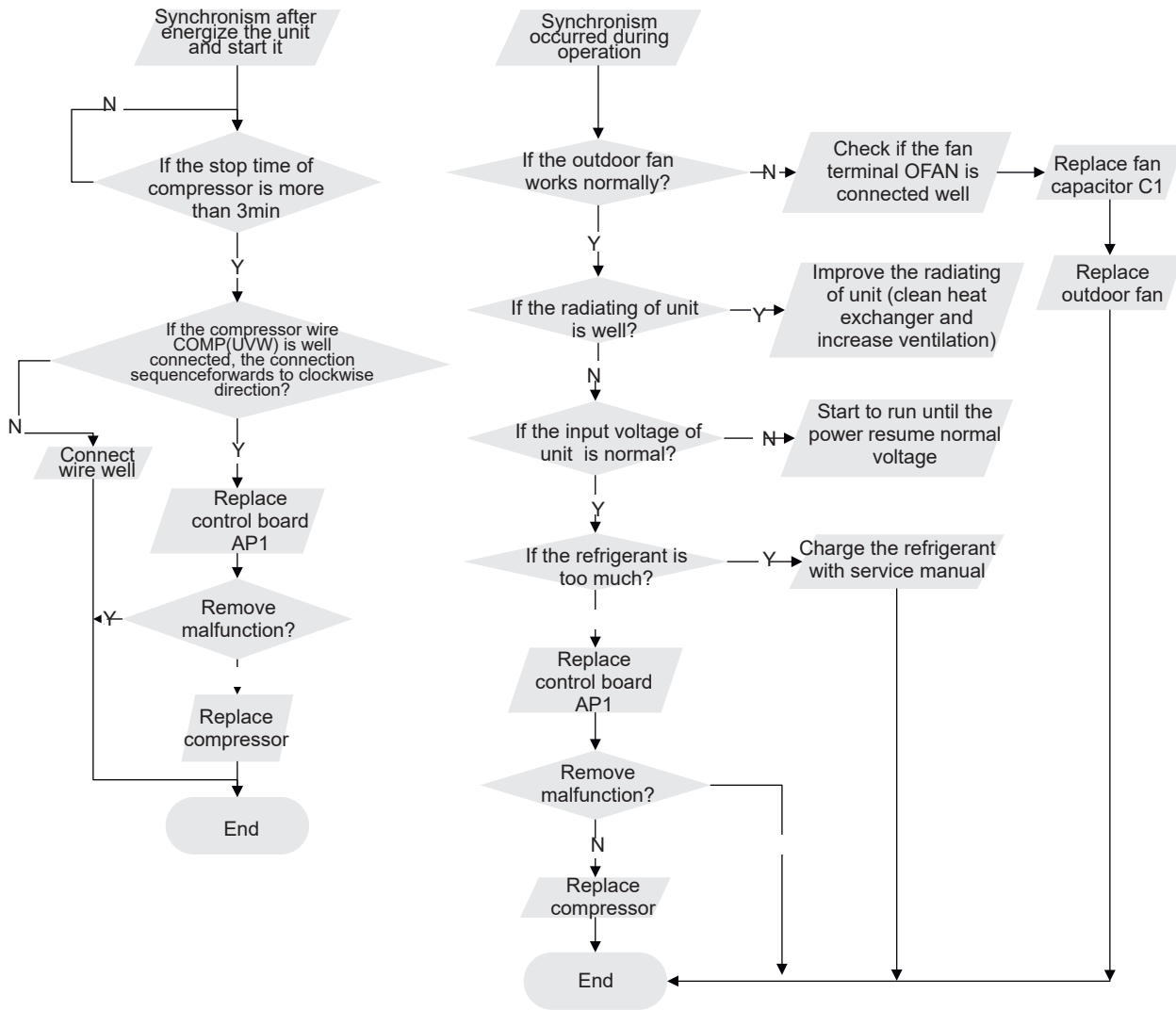

9. Maintenance

8. Overload and high discharge temperature malfunction

Main detection points:

- If the electronic expansion valve is connected well? Is the electronic expansion valve damaged?
- If the refrigerant is leaked?
- The compressor overload protection terminal is not connected well with the mainboard?
- If the overload protector is damaged?
- Heat exchange of unit is not good? (heat exchanger is dirty and unit radiating environment is bad)
- Too much load of the system causes high temperature of compressor after working for a long time?
- Malfunction of discharge temperature sensor?

9. Maintenance

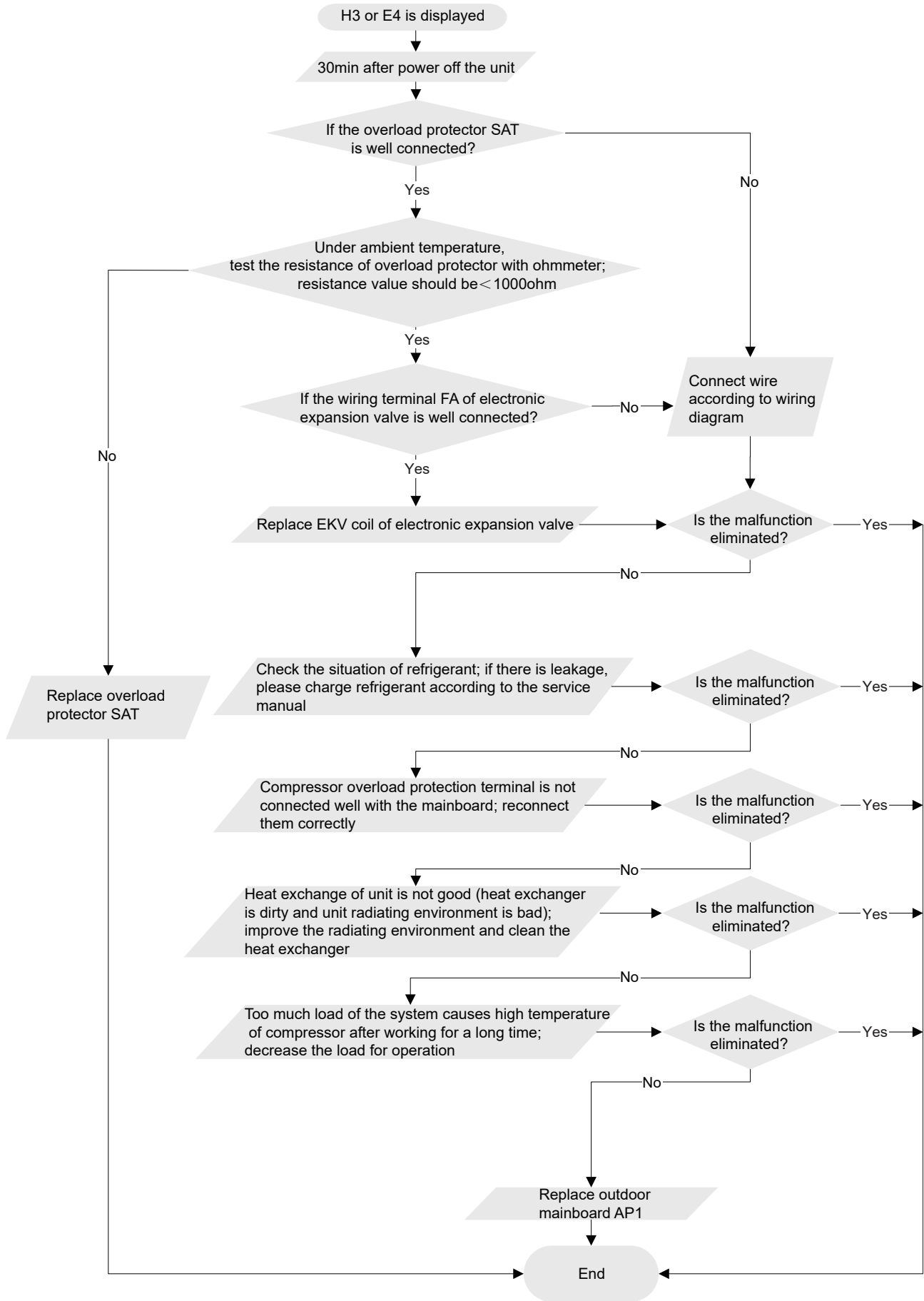

9. Maintenance

9.3 Troubleshooting for Normal Malfunction

1. Air Conditioner can't be Started Up

Possible Causes	Discriminating Method (Air conditioner Status)	Troubleshooting
No power supply, or poor connection for power plug	After energization, operation indicator isn't bright and the buzzer can't give out sound	Confirm whether it's due to power failure. If yes, wait for power recovery. If not, check power supply circuit and make sure the power plug is connected well.
Wrong wire connection between indoor unit and outdoor unit, or poor connection for wiring terminals	Under normal power supply circumstances, operation indicator isn't bright after energization	Check the circuit according to circuit diagram and connect wires correctly. Make sure all wiring terminals are connected firmly
Electric leakage for air conditioner	After energization, room circuit breaker trips off at once	Make sure the air conditioner is grounded reliably Make sure wires of air conditioner is connected correctly Check the wiring inside air conditioner. Check whether the insulation layer of power cord is damaged; if yes, place the power cord.
Model selection for air switch is improper	After energization, air switch trips off	Select proper air switch
Malfunction of remote controller	After energization, operation indicator is bright, while no display on remote controller or buttons have no action.	Replace batteries for remote controller Repair or replace remote controller

2. Poor Cooling (Heating) for Air Conditioner

Possible Causes	Discriminating Method (Air conditioner Status)	Troubleshooting
Set temperature is improper	Observe the set temperature on remote controller	Adjust the set temperature
Rotation speed of the IDU fan motor is set too low	Small wind blow	Set the fan speed at high or medium
Filter of indoor unit is blocked	Check the filter to see it's blocked	Clean the filter
Installation position for indoor unit and outdoor unit is improper	Check whether the installation position is proper according to installation requirement for air conditioner	Adjust the installation position, and install the rainproof and sunproof for outdoor unit
Refrigerant is leaking	Discharged air temperature during cooling is higher than normal discharged wind temperature; Discharged air temperature during heating is lower than normal discharged wind temperature; Units pressure is much lower than regulated range	Find out the leakage causes and deal with it. Add refrigerant.
Malfunction of 4-way valve	Blow cold wind during heating	Replace the 4-way valve
Malfunction of capillary	Discharged air temperature during cooling is higher than normal discharged wind temperature; Discharged air temperature during heating is lower than normal discharged wind temperature; Unit pressure is much lower than regulated range. If refrigerant isn't leaking, part of capillary is blocked	Replace the capillary
Flow volume of valve is insufficient	The pressure of valves is much lower than that stated in the specification	Open the valve completely
Malfunction of horizontal louver	Horizontal louver can't swing	Refer to point 3 of maintenance method for details
Malfunction of the IDU fan motor	The IDU fan motor can't operate	Refer to troubleshooting for H6 for maintenance method in details
Malfunction of the ODU fan motor	The ODU fan motor can't operate	Refer to point 4 of maintenance method for details
Malfunction of compressor	Compressor can't operate	Refer to point 5 of maintenance method for details

3. Horizontal Louver can't Swing

Possible Causes	Discriminating Method (Air conditioner Status)	Troubleshooting
Wrong wire connection, or poor connection	Check the wiring status according to circuit diagram	Connect wires according to wiring diagram to make sure all wiring terminals are connected firmly
Stepping motor is damaged	Stepping motor can't operate	Repair or replace stepping motor
Main board is damaged	Others are all normal, while horizontal louver can't operate	Replace the main board with the same model

9. Maintenance

4. ODU Fan Motor can't Operate

Possible causes	Discriminating method (air conditioner status)	Troubleshooting
Wrong wire connection, or poor connection	Check the wiring status according to circuit diagram	Connect wires according to wiring diagram to make sure all wiring terminals are connected firmly
Capacity of the ODU fan motor is damaged	Measure the capacity of fan capacitor with an universal meter and find that the capacity is out of the deviation range indicated on the nameplate of fan capacitor.	Replace the capacity of fan
Power voltage is a little low or high	Use universal meter to measure the power supply voltage. The voltage is a little high or low	Suggest to equip with voltage regulator
Motor of outdoor unit is damaged	When unit is on, cooling/heating performance is bad and ODU compressor generates a lot of noise and heat.	Change compressor oil and refrigerant. If no better, replace the compressor with a new one

5. Compressor can't Operate

Possible causes	Discriminating method (air conditioner status)	Troubleshooting
Wrong wire connection, or poor connection	Check the wiring status according to circuit diagram	Connect wires according to wiring diagram to make sure all wiring terminals are connected firmly
Capacity of compressor is damaged	Measure the capacity of fan capacitor with an universal meter and find that the capacity is out of the deviation range indicated on the nameplate of fan capacitor.	Replace the compressor capacitor
Power voltage is a little low or high	Use universal meter to measure the power supply voltage. The voltage is a little high or low	Suggest to equip with voltage regulator
Coil of compressor is burnt out	Use universal meter to measure the resistance between compressor terminals and it's 0	Repair or replace compressor
Cylinder of compressor is blocked	Compressor can't operate	Repair or replace compressor

6. Air Conditioner is Leaking

Possible causes	Discriminating method (air conditioner status)	Troubleshooting
Drain pipe is blocked	Water leaking from indoor unit	Eliminate the foreign objects inside the drain pipe
Drain pipe is broken	Water leaking from drain pipe	Replace drain pipe
Wrapping is not tight	Water leaking from the pipe connection place of indoor unit	Wrap it again and bundle it tightly

7. Abnormal Sound and Vibration

Possible causes	Discriminating method (air conditioner status)	Troubleshooting
When turn on or turn off the unit, the panel and other parts will expand and There's abnormal sound	There's the sound of "PAPA"	Normal phenomenon. Abnormal sound will disappear after a few minutes.
When turn on or turn off the unit, There's abnormal sound due to flow of refrigerant inside air conditioner	Water-running sound can be heard	Normal phenomenon. Abnormal sound will disappear after a few minutes.
Foreign objects inside the indoor unit or there're parts touching together inside the indoor unit	There's abnormal sound fro indoor unit	Remove foreign objects. Adjust all parts position of indoor unit, tighten screws and stick damping plaster between connected parts
Foreign objects inside the outdoor unit or there're parts touching together inside the outdoor unit	There's abnormal sound fro outdoor unit	Remove foreign objects. Adjust all parts position of outdoor unit, tighten screws and stick damping plaster between connected parts
Short circuit inside the magnetic coil	During heating, the way valve has abnormal electromagnetic sound	Replace magnetic coil
Abnormal shake of compressor	Outdoor unit gives out abnormal sound	Adjust the support foot mat of compressor, tighten the bolts
Abnormal sound inside the compressor	Abnormal sound inside the compressor	If add too much refrigerant during maintenance, please reduce refrigerant properly. Replace compressor for other circumstances.

10. Exploded View and Parts List

10.1 Indoor Unit

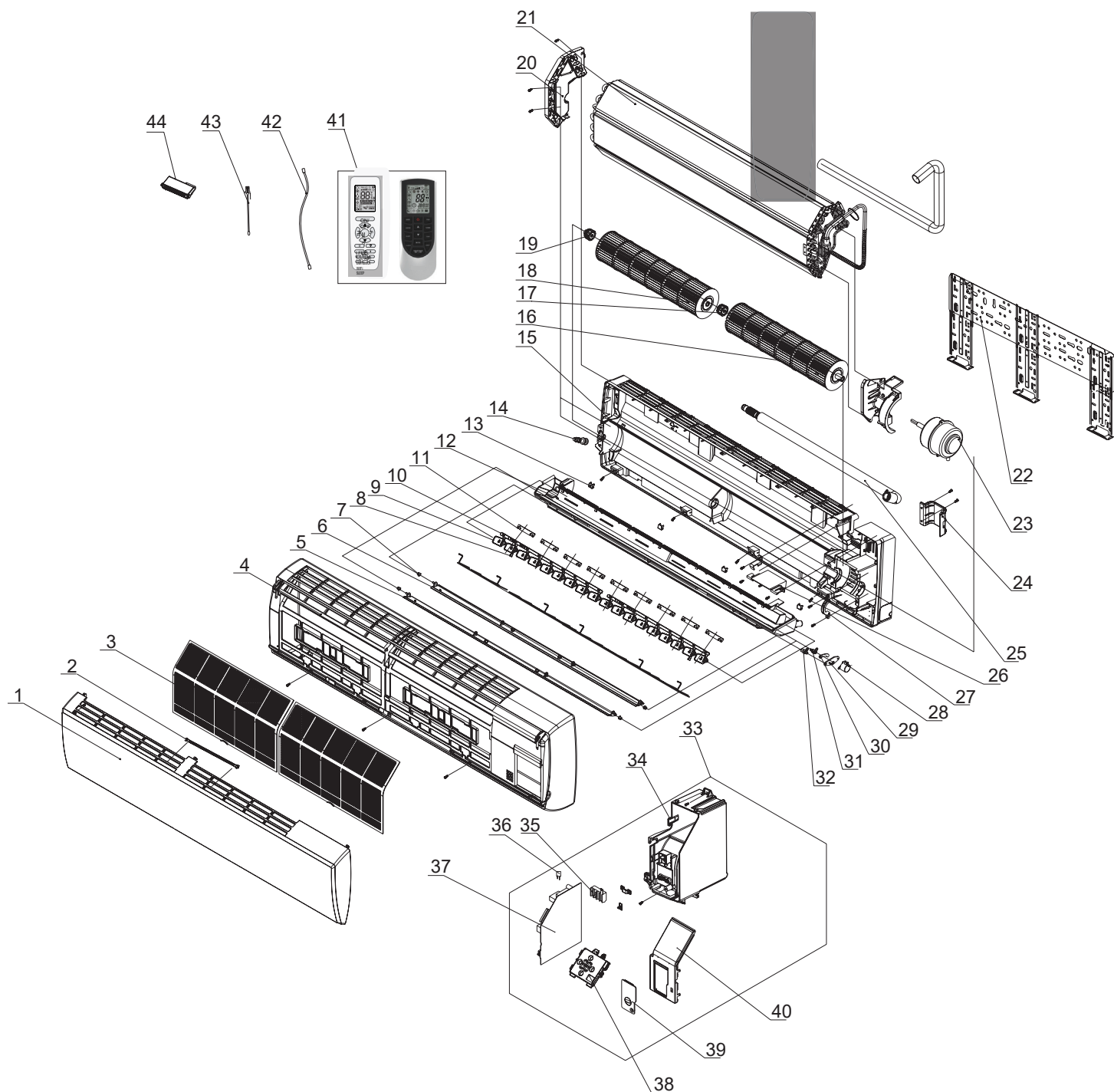

The component picture is only for reference; please refer to the actual product.

10. Exploded View and Parts List

NO.	Description
1	Front Panel
2	Stand Bar
3	Filter Sub-Assy
4	Front Case Sub-assy
5	Upper Guide Louver
6	Lower Guide Louver
7	Axile Bush
8	Air Louver 2
9	Air Louver 1
10	Connecting Rod
11	Louver Clamp
12	Water Tray
13	Screw Cover
14	Rubber Plug (Water Tray)
15	Rear Case assy
16	Cross Flow Fan 1
17	Bearing Holder Sub-assy
18	Cross Flow Fan 2
19	O-Gasket sub-assy of Bearing
20	Left Evaporator Support
21	Evaporator Assy
22	Wall Mounting Frame

NO.	Description
23	Fan Motor
24	Pipe Clamp
25	Drainage Hose
26	Cover Plate
27	Motor Fixed Clip 1
28	Stepping Motor
29	Press Plate(Crank)
30	Crank-guide
31	Upper Crank
32	Lower crank
33	Electric Box Assy
34	Electric Box
35	Terminal Board
36	Jumper
37	Main Board
38	Display Board
39	Electric Box Cover 2
40	Electric Box Cover
41	Remote Controller
42	Connecting Cable
43	Temperature Sensor
44	Detecting Plate

Some models may not contain some parts, please refer to the actual product.

10. Exploded View and Parts List

10.2 Outdoor Unit

INTENTIONALLY BLANK

Some models may not contain some parts, please refer to the actual product.

INTENTIONALLY BLANK

11. Removal Procedure

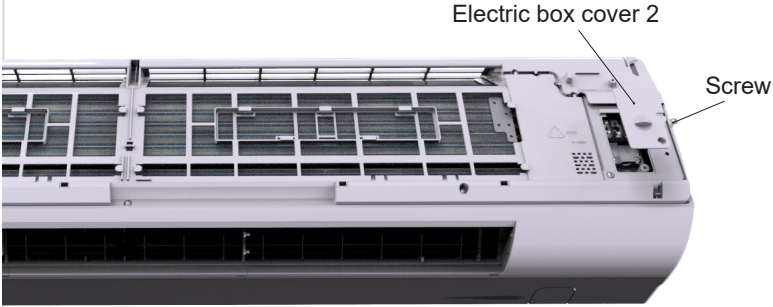
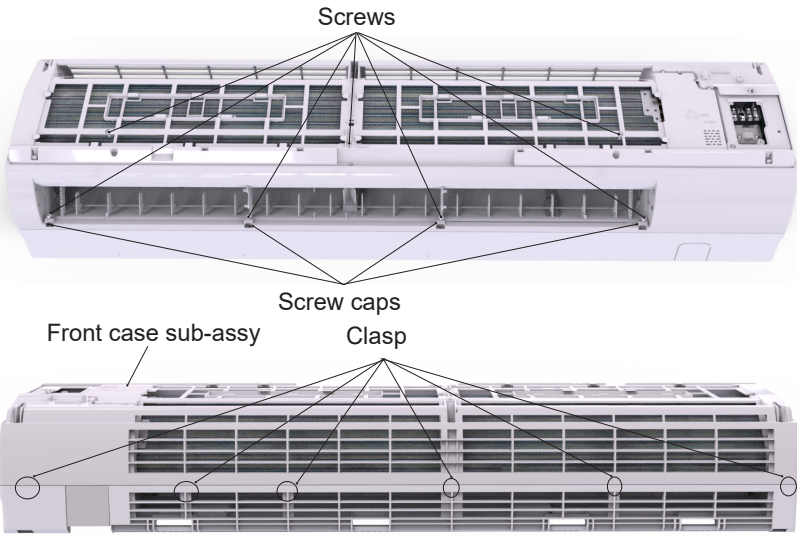
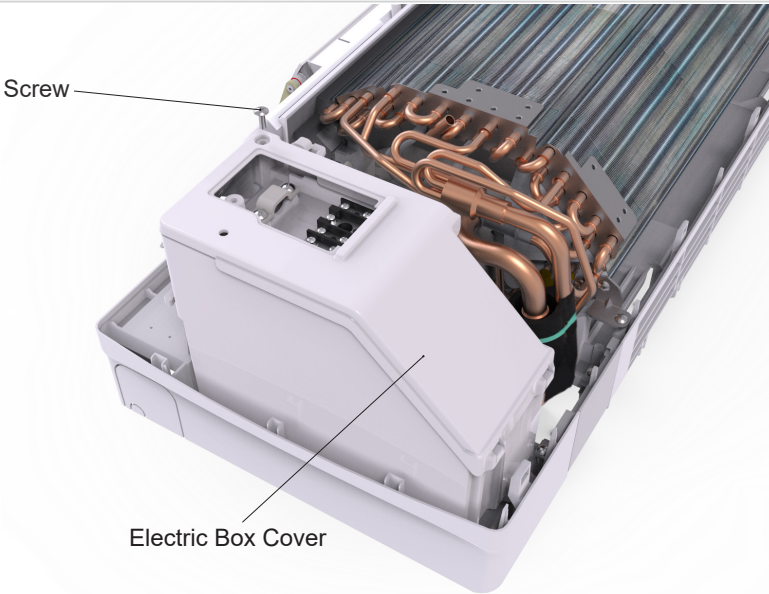
Step	Procedure
<p>3.Remove electric box cover 2</p>	<p>Remove the screws on the electric box cover 2 to remove the electric box cover 2.</p>  <p>Labels: Electric box cover 2, Screw</p>
<p>4.Remove front case sub-assy</p> <p>a Open the screw caps on front case.</p> <p>b Remove the screws fixing front case.</p> <p>c Loosen the clasps of front case. Lift the front case sub-assy upwards to remove it.</p>	 <p>Labels: Screws, Screw caps, Front case sub-assy, Clasp</p>
<p>5.Remove electric box cover</p>	<p>Remove the screw fixing electric box cover to remove the electric box cover.</p>  <p>Labels: Screw, Electric Box Cover</p>

11. Removal Procedure

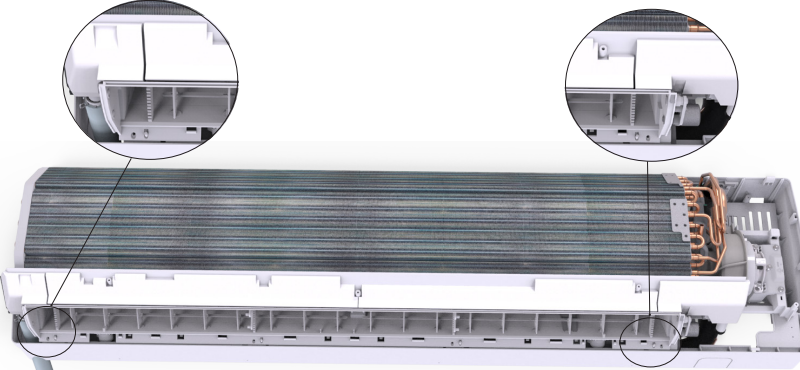
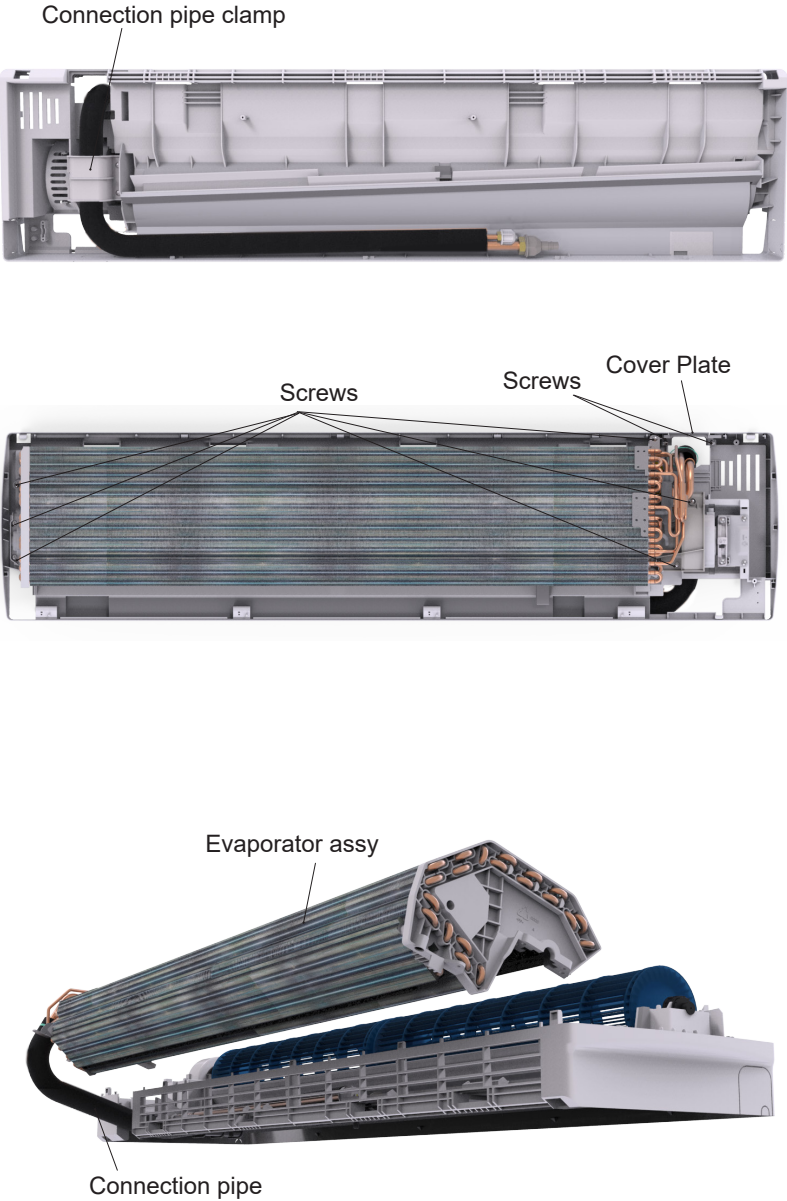
Step	Procedure
7.Remove water tray sub-assy	 <p>Pull the water tray upwards, and then remove the water tray.</p>
8.Remove evaporator assy	 <p>a Remove two screws on pipe clamp, and then remove the pipe clamp.</p> <p>b Remove two screws on cover plate, and then remove the cover plate. Remove the screws fixing left and right evaporator support, then slightly adjust the pipeline.</p> <p>c Extract the evaporator up.</p>

11. Removal Procedure



11.2 Removal Procedure of Outdoor Unit

4LIV30HP230V1AO 4LIV36HP230V1AO

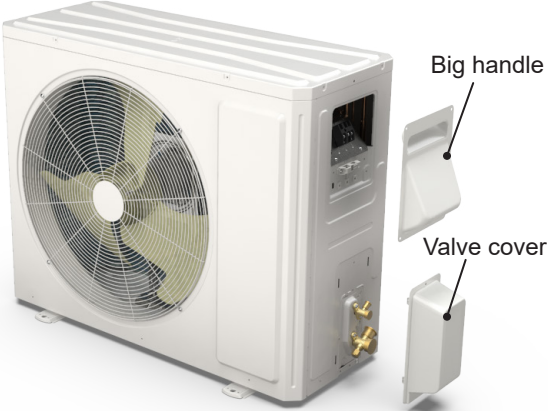

Caution: discharge the refrigerant completely before removal.

NOTE: Take heat pump for example.

Step	Procedure
1. Before disassembly	
2. Remove big handle and valve cover	<p>Remove the screws fixing big handle, valve cover and then remove them.</p> 
3. Remove top cover	<p>Remove the screws fixing top panel and then remove the top panel.</p> 

11. Removal Procedure

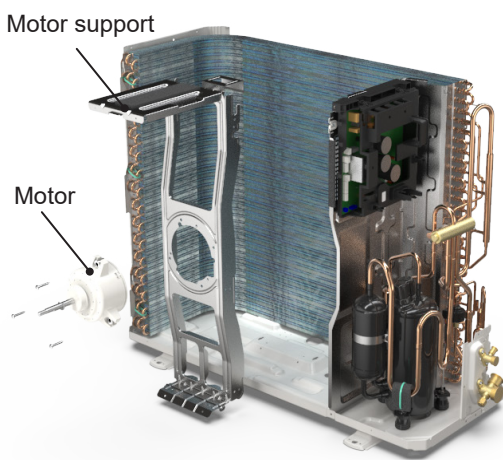
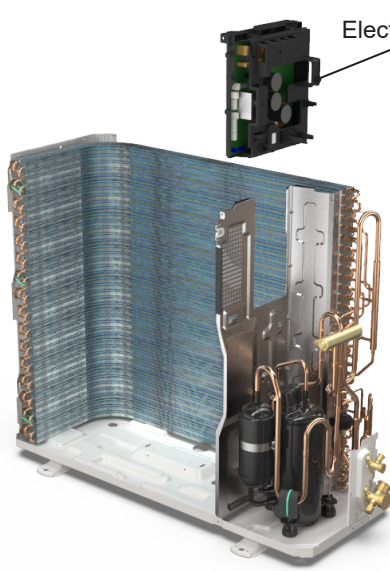
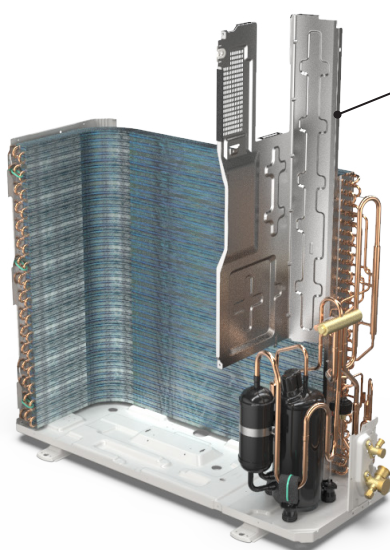
Step	Procedure
7. Remove motor support and motor	<p>Remove the screws fixing the motor support and lift the motor support to remove it.</p> <p>Remove the screws fixing the motor and then remove the motor.</p> 
8. Remove electric box assy	<p>Remove the terminals, lift up and rotate the electrical box assy to the right so that the snaps on the clapboard are removed and the electrical box assy are removed.</p> 
9. Remove clapboard assy	<p>Remove the screws fixing the clapboard assy and then remove the clapboard assy.</p> 

INTENTIONALLY BLANK

INTENTIONALLY BLANK

11. Removal Procedure

INTENTIONALLY BLANK

INTENTIONALLY BLANK

INTENTIONALLY BLANK

Appendix:

Appendix 1: Reference Sheet of Celsius and Fahrenheit

Conversion formula for Fahrenheit degree and Celsius degree: $T_f = T_c \times 1.8 + 32$

Set temperature

Fahrenheit display temperature (°F)	Fahrenheit (°F)	Celsius (°C)	Fahrenheit display temperature (°F)	Fahrenheit (°F)	Celsius (°C)	Fahrenheit display temperature (°F)	Fahrenheit (°F)	Celsius (°C)
61	60.8	16	69/70	69.8	21	78/79	78.8	26
62/63	62.6	17	71/72	71.6	22	80/81	80.6	27
64/65	64.4	18	73/74	73.4	23	82/83	82.4	28
66/67	66.2	19	75/76	75.2	24	84/85	84.2	29
68	68	20	77	77	25	86	86	30

Ambient temperature

Fahrenheit display temperature (°F)	Fahrenheit (°F)	Celsius (°C)	Fahrenheit display temperature (°F)	Fahrenheit (°F)	Celsius (°C)	Fahrenheit display temperature (°F)	Fahrenheit (°F)	Celsius (°C)
32/33	32	0	55/56	55.4	13	79/80	78.8	26
34/35	33.8	1	57/58	57.2	14	81	80.6	27
36	35.6	2	59/60	59	15	82/83	82.4	28
37/38	37.4	3	61/62	60.8	16	84/85	84.2	29
39/40	39.2	4	63	62.6	17	86/87	86	30
41/42	41	5	64/65	64.4	18	88/89	87.8	31
43/44	42.8	6	66/67	66.2	19	90	89.6	32
45	44.6	7	68/69	68	20	91/92	91.4	33
46/47	46.4	8	70/71	69.8	21	93/94	93.2	34
48/49	48.2	9	72	71.6	22	95/96	95	35
50/51	50	10	73/74	73.4	23	97/98	96.8	36
52/53	51.8	11	75/76	75.2	24	99	98.6	37
54	53.6	12	77/78	77	25			

Appendix 2: Configuration of Connection Pipe

- Standard length of connection pipe (More details please refer to the specifications.)
- Min length of connection pipe For the unit with standard connection pipe of 5m, there is no limitation for them in length of connection pipe. For the unit with standard connection pipe of 7.5m and 8m, the min length of connection pipe is 3m.
- Max. length of connection pipe and max. high difference. (More details please refer to the specifications.)
- The additional refrigerant oil and refrigerant charging required after prolonging connection pipe
 - After the length of connection pipe is prolonged for 10m at the basis of standard length, you should add 5ml of refrigerant oil for each additional 5m of connection pipe.
 - The calculation method of additional refrigerant charging amount (on the basis of liquid pipe):
 - Basing on the length of standard pipe, add refrigerant according to the requirement as shown in the table. The additional refrigerant charging amount per meter is different according to the diameter of liquid pipe. See the following sheet.
 - Additional refrigerant charging amount = prolonged length of liquid pipe X additional refrigerant charging amount per meter

Additional refrigerant charging amount for R22, R407C, R410A and R134a

Diameter of connection pipe		Outdoor unit throttle	
Liquid pipe	Gas pipe	Cooling only(g/m)	Cooling and heating(g/m)
1/4"	3/8" or 1/2"	15	20
1/4" or 3/8"	5/8" or 3/4"	15	50
1/2"	3/4" or 7/8"	30	120
5/8"	1" or 1 1/4"	60	120

Appendix:

Appendix 3: Pipe Expanding Method

⚠ Note:

Improper pipe expanding is the main cause of refrigerant leakage. Please expand the pipe according to the following steps:

A: Cut the pipe

- Confirm the pipe length according to the distance of indoor unit and outdoor unit.
- Cut the required pipe with pipe cutter.

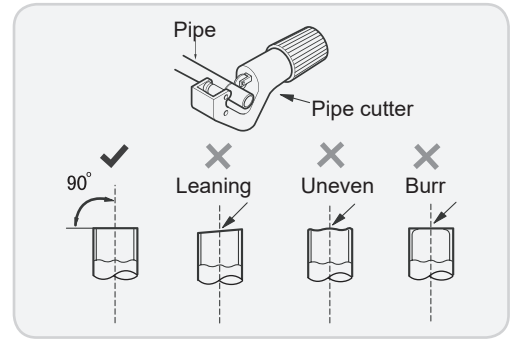

B: Remove the burrs

- Remove the burrs with shaper and prevent the burrs from getting into the pipe.

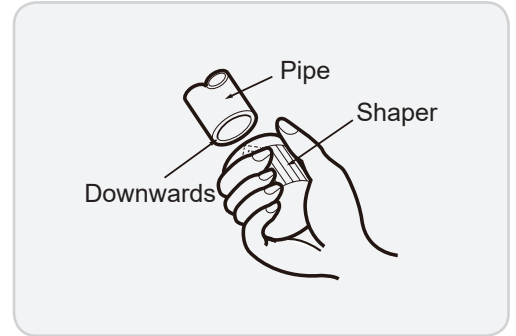

C: Put on suitable insulating pipe.

D: Put on the union nut

- Remove the union nut on the indoor connection pipe and outdoor valve; install the union nut on the pipe.

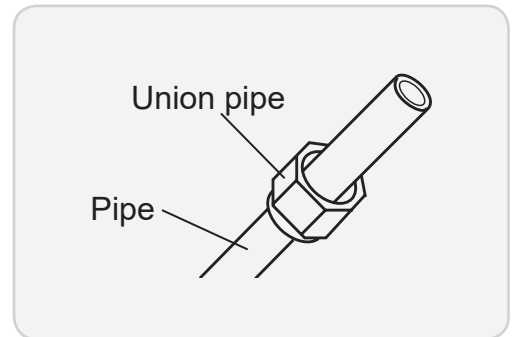

E: Expand the port

- Expand the port with expander.

⚠ Note:

- "A" is different according to the diameter, please refer to the sheet below:

Outer diameter(mm)	A(mm)	
	Max	Min
Φ6 - 6.35 (1/4")	1.3	0.7
Φ9 - Φ9.52 (3/8")	1.6	1.0
Φ12 - 12.70 (1/2")	1.8	1.0
Φ16 - 15.88 (5/8")	2.4	2.2

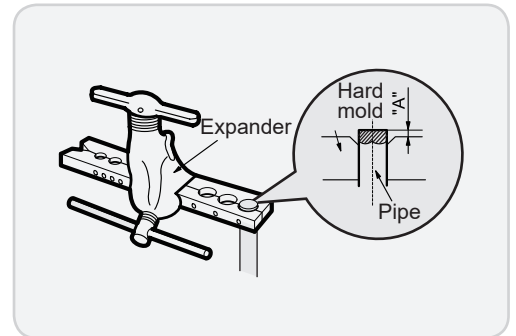

F: Inspection

- Check the quality of expanding port. If there is any blemish, expand the port again according to the steps above.

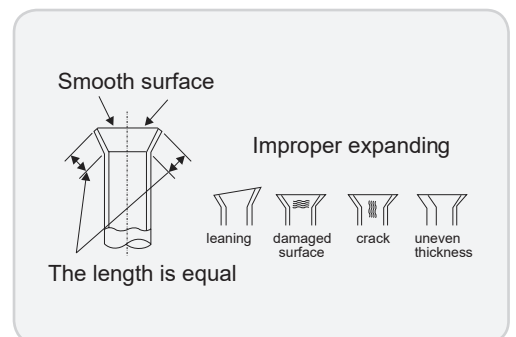



JF00304966



GREE ELECTRIC APPLIANCES, INC. OF ZHUHAI

Add: West Jinji Rd, Qianshan, Zhuhai, Guangdong, China, 519070

Tel: (+86-756) 8522219

Fax: (+86-756) 8669426

E-mail: global@cn.gree.com www.gree.com

GREE 4LIV30-36 SERVICE 0122023

For product improvement, specifications and appearance in this manual are subject to change without prior notice.